

REMOTE CONTROLLER OPERATION

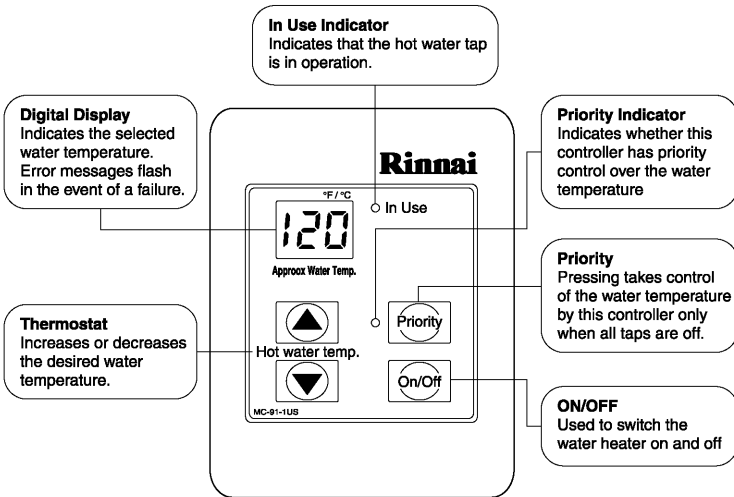

Diagnostic Use of Controller

- To Display Maintenance Codes: Press the 'On/Off' button once to turn the controller off. Press and hold the 'On/Off' button followed by ▲ thermostat button to cycle through the maintenance codes.
- To Display Water Flow through the water heater: Press the ▲ thermostat button and hold for 2 seconds and then press the 'On/Off' button while continuing to hold the ▲ thermostat button.
- To Display Outlet Water Temperature: Press the ▼ thermostat button and hold for 2 seconds and then press the 'On/Off' button while continuing to hold the ▼ thermostat button.

To Change the Temperature Display from °F to °C (or °C to °F)

- Press the 'On/Off' button once to turn the controller unit off. With the controller off press and hold the 'On/Off' button until the display changes to °C (°F), approximately 5 seconds.

To Turn Off the Sound (Mute)

- To turn the sound off (mute) press and hold both the ▲ and ▼ thermostat buttons until an audible "beep" is heard, approximately 5 seconds.

GAS PRESSURE SETTING AND DIAGNOSTICS INFORMATION

NOTE: For additional installation and commissioning information refer to Operation / Installation Manual



THIS APPLIANCE MUST BE INSTALLED, SERVICED AND REMOVED BY AN AUTHORISED PERSON DURING PRESSURE TESTING OF THE CONSUMER PIPING ENSURE GAS COCK SITUATED BEFORE UNIT IS SHUT-OFF. FAILURE TO DO SO MAY RESULT IN SERIOUS DAMAGE TO THE APPLIANCE AND POSSIBLE INJURY.

APPLIANCE OPERATING PRESSURES

Table 1.

	Water Inlet Min.	Gas Inlet Min./Max.		Forced Low		Forced High	
		Nat.G	Prop.G	Nat.G	Prop.G	Nat.G	Prop.G
REU-V2532FFUD	150 PSI	6"W.C. 10.5"W.C.	10"W.C. 13.5"W.C.	0.77"W.C.	0.93"W.C.	3.7"W.C.	4.2"W.C.
REU-V2532FFUCD							
REU-V2520FFUD							
REU-V2520FFUCD							

COMMISSIONING

With all gas appliances in operation at maximum gas rate, the flowing inlet pressure at the incoming test point on the Rinnai Water Heater should read 6"W.C. - 10.5"W.C. on Natural Gas and 10"W.C. - 13.5"W.C. on Propane Gas. If the pressure is lower, the gas supply is inadequate and the appliance unit will not operate to specification. Check gas meter, regulator and pipework for correct operation/sizing and rectify as required.

GAS PRESSURE SETTING

(Ensure gas pressure check under Commissioning above has been completed first !)

The regulator is electronically controlled and factory pre-set. **Under normal circumstances it does not require adjustment during installation. Make adjustments only if the unit is not operating correctly and all other possible causes for incorrect operation have been eliminated.**

- Turn 'OFF' the gas supply.
- Turn 'OFF' 120V power supply.
- Remove the front cover from the appliance.
- Check gas type switches (Fig.1) are in the correct position (dip switch 1 of SW2 'ON' = NG, 'OFF' = LPG)

Note: 'ON' towards front, 'OFF' towards rear.

- Attach pressure gauge to burner test point, located on the gas control. (Fig.2).
- Turn 'ON' the gas supply.
- Turn 'ON' 120V power supply.
- If remote controllers are fitted, turn the unit 'ON' at the kitchen controller, select the maximum delivery temperature and open all available hot water taps full including the shower. (**CAUTION:** Ensure building occupants do not have access to hot water outlets during this procedure).
- Set the Infinity to 'Forced Low' combustion by setting No.7 dip switch of the (SW1) set of dip switches to 'ON'.(Fig.3).
- Check the burner test point pressure.
- Remove rubber access plug and adjust the regulator screw on the modulating valve (Fig.4) as required in Table 1. Replace rubber access plug.
- Set the Rinnai Water Heater to 'Forced High' combustion by setting both No. 7 and No. 8 dip switches of the bottom (SW1) set to 'ON'. (Fig.5). **Ensure maximum water flow !**
- Check the burner test point pressure.
- Adjust the high pressure Potentiometer (POT) on the Printed Circuit Board (PCB) as required to the pressure shown in Table 1.

IMPORTANT: Set dip switches 7 and 8 on the bottom (SW1) to 'OFF' to return the appliance to 'Normal' combustion. (Fig. 6).

- Close hot water tap.
- Turn 'OFF' the gas supply and 120V power supply.
- Remove pressure gauge & replacing sealing screw.
- Turn 'ON' the gas supply and 120V power supply.
- Operate unit and check for gas leaks at test point.
- Replace the front cover of the appliance.

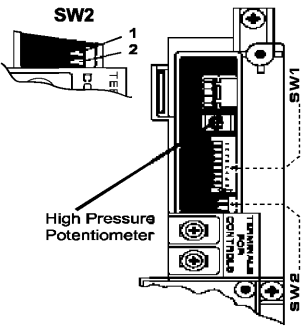

Fig. 1

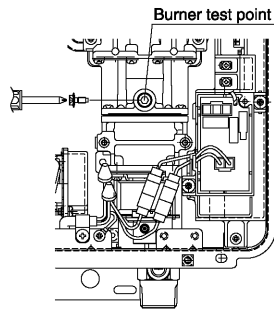

Fig. 2

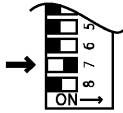

Fig. 3

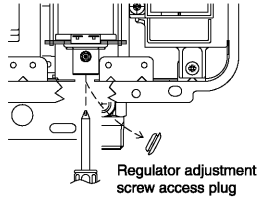

Fig. 4

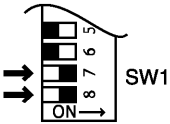

Fig. 5



Fig. 6



In appropriate Dip Switch setting can damage the Rinnai water heater and may void the warranty of this unit

Error	Fault	Items to Inspect
02	No burner operation during freeze protection mode	Service Call
03	Power interruption during Bath fill (Water will not flow when power returns).	Turn off all hot water taps. Press ON/OFF twice.
10	Air Supply or Exhaust Blockage	Ensure Rinnai approved venting materials are being used. Check that nothing is blocking the flue inlet or exhaust. Check all vent components for proper connections. Ensure vent length is within limits. Ensure condensation collar was installed correctly. Verify dip switches are set properly. Check fan for blockage.
11	No Ignition	Check that the gas is turned on at the water heater, gas meter, or cylinder. Ensure gas type and pressure is correct. Ensure gas line, meter, and/or regulator is sized properly. Bleed all air from gas lines. Verify dip switches are set properly. Ensure appliance is properly grounded. Disconnect all MSA controls. Ensure igniter is operational. Check igniter wiring harness for damage. Check gas solenoid valves for open or short circuits. Remove burner cover and ensure all burners are properly seated. Remove burner plate and inspect burner surface for condensation or debris.
12	Flame Failure	Check that the gas is turned on at the water heater and gas meter. Check for obstructions in the flue outlet. Ensure gas line, meter, and/or regulator is sized properly. Ensure gas type and pressure is correct. Bleed all air from gas lines. Ensure proper Rinnai venting material was installed. Ensure condensation collar was installed properly. Ensure vent length is within limits. Verify dip switches are set properly. Ensure appliance is properly grounded. Disconnect keypad. Disconnect all MSA controls if installed. Check power supply for loose connections. Check power supply for proper voltage and voltage drops. Ensure flame rod wire is connected. Check flame rod for carbon build-up. Disconnect and re-connect all wiring harnesses on unit and PC board. Check all components for electrical short. Check gas solenoid valves for open or short circuits. Remove burner plate and inspect burner surface for condensation or debris.
14	Thermal Fuse	Check gas type of unit and ensure it matches gas type being used. Check for restrictions in air flow around unit and vent terminal. Check for low water flow in a circulating system causing short-cycling. Ensure dip switches are set to the proper position. Check for foreign materials in combustion chamber and/or exhaust piping. Check heat exchanger for cracks and/or separations. Check heat exchanger surface for hot spots which indicate blockage due to scale build-up. Refer to instructions in manual for flushing heat exchanger. Measure resistance of safety circuit. Ensure high fire and low fire manifold pressure is correct. Check for improper conversion of product.
16	Over Temperature Warning	Check for restrictions in air flow around unit and vent terminal. Check for low water flow in a circulating system causing short-cycling. Check for foreign materials in combustion chamber and/or exhaust piping. Check for clogged heat exchanger.
32	Outgoing Water Temperature Sensor Fault	Check sensor wiring for damage. Measure resistance of sensor. Clean sensor of scale build-up. Replace sensor.
33	Heat Exchanger Outgoing Temperature Sensor Fault	Check sensor wiring for damage. Measure resistance of sensor. Clean sensor of scale build-up. Replace sensor.
34	Combustion Air Temperature Sensor Fault	Check for restrictions in air flow around unit and vent terminal. Check sensor wiring for damage. Measure resistance of sensor. Clean sensor of scale build-up. Ensure fan blade is tight on motor shaft and is in good condition. Replace sensor.
52	Modulating Solenoid Valve Signal Abnormal	Check modulating gas solenoid valve wiring harness for loose or damage terminals. Measure resistance of valve coil.
61	Combustion Fan Failure	Ensure fan will turn freely. Check wiring harness to motor for damaged and/or loose connections. Measure resistance of motor winding.
65	Water Flow Servo Faulty (Does not stop flow properly)	Water Flow Servo or wiring faulty. Check Water Flow Servo wiring harness connection. Measure resistance of Water Flow Servo wiring. If blank screen is present on remote control then the Water Flow Servo has shorted out. Unplug Water Flow Servo. If remote lights up and unit starts operating then replace Water Flow Servo.
71	SV0, SV1, SV2, and SV3 Solenoid Valve Circuit Fault	Check wiring harness to all solenoids for damage and/or loose connections. Measure resistance of each solenoid valve coil.

Rinnai Water Heaters Dip Switch Default Settings

The settings below are factory default settings. Please ensure the model number and gas type of the unit you have, matches the model number and gas type listed below; before settings any switches. If you need assistance, contact Rinnai at (800)621-9419 before proceeding.

Residential Units Dip Switch Settings ◆REU-V2532FFUD		Commercial Units Dip Switch Settings ◆REU-V2532FFUCD		Residential Units Dip Switch Settings ◆REU-V2520FFUD		Commercial Units Dip Switch Settings ◆REU-V2520FFUCD	
LPG	NAT.G	LPG	NAT.G	LPG	NAT.G	LPG	NAT.G
ON	ON	ON	ON	ON	ON	ON	ON
OFF	OFF	OFF	OFF	OFF	OFF	OFF	OFF
1	1	1	1	1	1	1	1
2	2	2	2	2	2	2	2
3	3	3	3	3	3	3	3
4	4	4	4	4	4	4	4
5	5	5	5	5	5	5	5
6	6	6	6	6	6	6	6
7	7	7	7	7	7	7	7
8	8	8	8	8	8	8	8

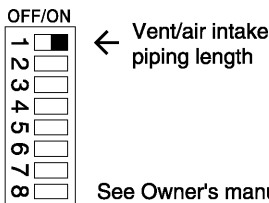

See Owner's manual for more in informd detail.

WARNING
In appropriate Dip Switch setting can damage the Rinnai water heater and may void the warranty of this unit

Error	Fault	Items to Inspect
72	Flame Sensing Device Fault	Ensure flame rod is touching flame when unit fires. Check all wiring to flame rod for damage. Remove flame rod and check for carbon build-up; clean with sand paper. Check inside burner chamber for any foreign material blocking flame at flame rod. Measure micro amp output of sensor circuit with flame present. Replace flame rod.
LC 00	Scale Build-up in Heat Exchanger (when checking maintenance code history '00' is substituted for 'LC')	Flush heat exchanger. Refer to instructions in manual. Replace heat exchanger.
No code	Nothing happens when water flow is activated.	Clean inlet water supply filter. On new installations ensure hot and cold water lines are not reversed. Check for bleed over. Isolate unit from building by turning off hot water line to building. Isolate the circulating system if present. Open your pressure relief valve; if unit fires, there is bleed over in your plumbing. Ensure you have at least the minimum flow rate required to fire unit. Ensure turbine spins freely. Measure the resistance of the water flow control sensor. Remote control does not light up but you have 12 VDC at the terminals for controls.

SERVICEMAN'S TROUBLESHOOTING INFORMATION for the RINNAI WATER HEATERS

IMPORTANT SAFETY NOTES:

There are a number of (live) tests that are required when fault finding this product. Extreme care should be used at all times to avoid contact with energized components inside the water heater. **Only trained and qualified service agencies should attempt to repair this product.** Remember, before checking for resistance readings, you should disconnect the power source to the unit and isolate the item to be checked from the circuit (unplug it).

(TR) Transformer:

Wire color	Voltage	Resistance	Connector #	Pin #'s
Black ~ White	90 ~ 100 VAC	51 ~ 63 ohms	F9	1 ~ 2
Blue ~ Brown	108 ~ 132 VAC	51 ~ 63 ohms	F7	1 ~ 3

(SV1, SV2, SV3 and POV) Gas valve and Modulating solenoids: (Set meter above 2K)

(Main) Pink ~ Black	80 ~ 100 VDC	1.7K ~ 2K ohms	E1	1 ~ 2
(SV1) Black ~ Yellow	80 ~ 100 VDC	1.7K ~ 2K ohms	E2	2 ~ 3
(SV2) Black ~ Blue	80 ~ 100 VDC	1.7K ~ 2K ohms	E3	2 ~ 4
(SV3) Black ~ Brown	80 ~ 100 VDC	1.7K ~ 2K ohms	E4	2 ~ 5
(POV) Pink ~ Pink	2 ~ 15 VDC	67 ~ 81 ohms	C2	3 ~ 4

(M) Water Flow Control Device Servo or Geared Motor:

Red ~ Blue	11 ~ 13 VDC	22 ~ 26 ohms	B2	9 ~ 10
Grey ~ Brown	4 ~ 6 VDC	N / A	B2	5 ~ 7
Grey ~ Yellow	N / A	N / A	B2	5 ~ 8
Grey ~ Orange	11 ~ 14 VDC	N / A	B2	5 ~ 6

NOTE: The grey wire listed above turns to black at B connector on the PCB, the orange wire turns to red.

(GS) Water Flow Sensor:

Black ~ Red	11 ~ 13 VDC	5.5K ~ 6.2K	B4	5 ~ 6
Yellow ~ Black	4 ~ 7 VDC	1 meg ~ 1.4 meg	B4	1 ~ 5

By-pass Flow Control: (REU-V2532FFU/FFUC ONLY)

Brown ~ White	2 ~ 6 VDC	Unit in operating mode	G4 ~ G5	4 ~ 5
Orange ~ White			G2 ~ G5	2 ~ 5
Yellow ~ White		15 ~ 35K	G1 ~ G5	1 ~ 5
Red ~ White/ Ground			G3 ~ G5	3 ~ 5

(IG) Ignition System:

Grey ~ Grey	90 ~ 100 VAC	N/A	A1	1 ~ 2
-------------	--------------	-----	----	-------

(FM) Combustion Fan Motor:

Red ~ Black	6 ~ 45 VDC	N/A	A1	1 ~ 2
White ~ Black	5 ~ 10 VDC	9.2K ~ 9.4K	A1	2 ~ 4
Yellow ~ Black	11 ~ 13 VDC	3.5K ~ 3.9K	A1	2 ~ 3

Set your meter to the hertz scale. Reading across the red and yellow wires at terminals 2 and 3 you should read between 60 and 350 hertz.

Thermal Fuse:

Red ~ Red	12 VDC	Below 1 ohm	B ~ C	B6 ~ C1
-----------	--------	-------------	-------	---------

Overheat Switch:

Red ~ Red	12 VDC	Below 1 ohm	B ~ C	B6 ~ C1
-----------	--------	-------------	-------	---------

Flame Rod:

Place one lead of your meter to the flame rod and the other to earth or ground. With the unit running you should read between 5 ~ 150 VAC. Set your meter to the μ amp scale, series your meter in line with the flame rod. You should read 1μ or greater for proper flame circuit. In the event of low flame circuit remove the flame rod and check for carbon and/or damage.

Heat Exchanger, Air Temperature, and Outgoing Water Temperature Thermistors:

Check all thermistors by inserting meter leads into each end of the thermistor plug. Set your meter to the 20K scale and read resistance. You should be able to apply heat to the thermistor bulb and see the resistance decrease. Then apply some ice to the thermistor and the resistance should increase. See below for examples of temperatures and resistance reading at those temperatures.

Example: 59°F = 11.4 ~ 14K

86°F = 6.4 ~ 7.8K

113°F = 3.6 ~ 4.5K

140°F = 2.2 ~ 2.7K

221°F = 0.6 ~ 0.8K

Outgoing Water Thermistor:

White ~ White	N/A	See example above	B	B3 ~ B4
---------------	-----	-------------------	---	---------

Heat Exchanger Temperature Thermistor:

White ~ White	N/A	See example above	B	B3 ~ B12
---------------	-----	-------------------	---	----------

Surge Protector:

Black ~ White	108 ~ 132 VAC	N/A	Surge Protector D1	1 ~ 3
Blue ~ Brown	108 ~ 132 VAC	N/A	Surge Protector D2	1 ~ 2

With the power off you can check the continuity through the surge protector. Place one meter lead on the top pin #1 of the surge protector and pin #2 on the bottom of the surge protector. Then check across top pin #3 and bottom pin #1, if you read continuity across these two points the surge protector is good. If you do not get continuity, replace the surge protector.

Remote Controls:

Terminals D1, D2	10 ~ 13 VDC digital	1.5K ~ 1.9K ohms	H	1 ~ 3
------------------	---------------------	------------------	---	-------

Frost Protection:

This unit has four frost protection heaters mounted at different points inside the unit, to protect the water heater from freeze ups. There are two heaters located on the outlet hot water line next to the thermistor.

Using a voltage meter set on the 200 ohm scale, you should have a resistance reading of 26 ~ 30 ohms through each of these heaters. The heater located on the heat exchanger piping should have a resistance reading of 81 ~ 86 ohms and the one located in the water flow sensor valve has a resistance reading of 16 ~ 19 ohms. Voltage throughout this circuit should be 120 VAC.

Amp Fuses:

This unit has two inline (3) amp glass fuses. Remove the fuse and check continuity through it. If you have Continuity through the fuse, it is good. If you can not read continuity, the fuse is blown and must be replaced.

WIRING DIAGRAM

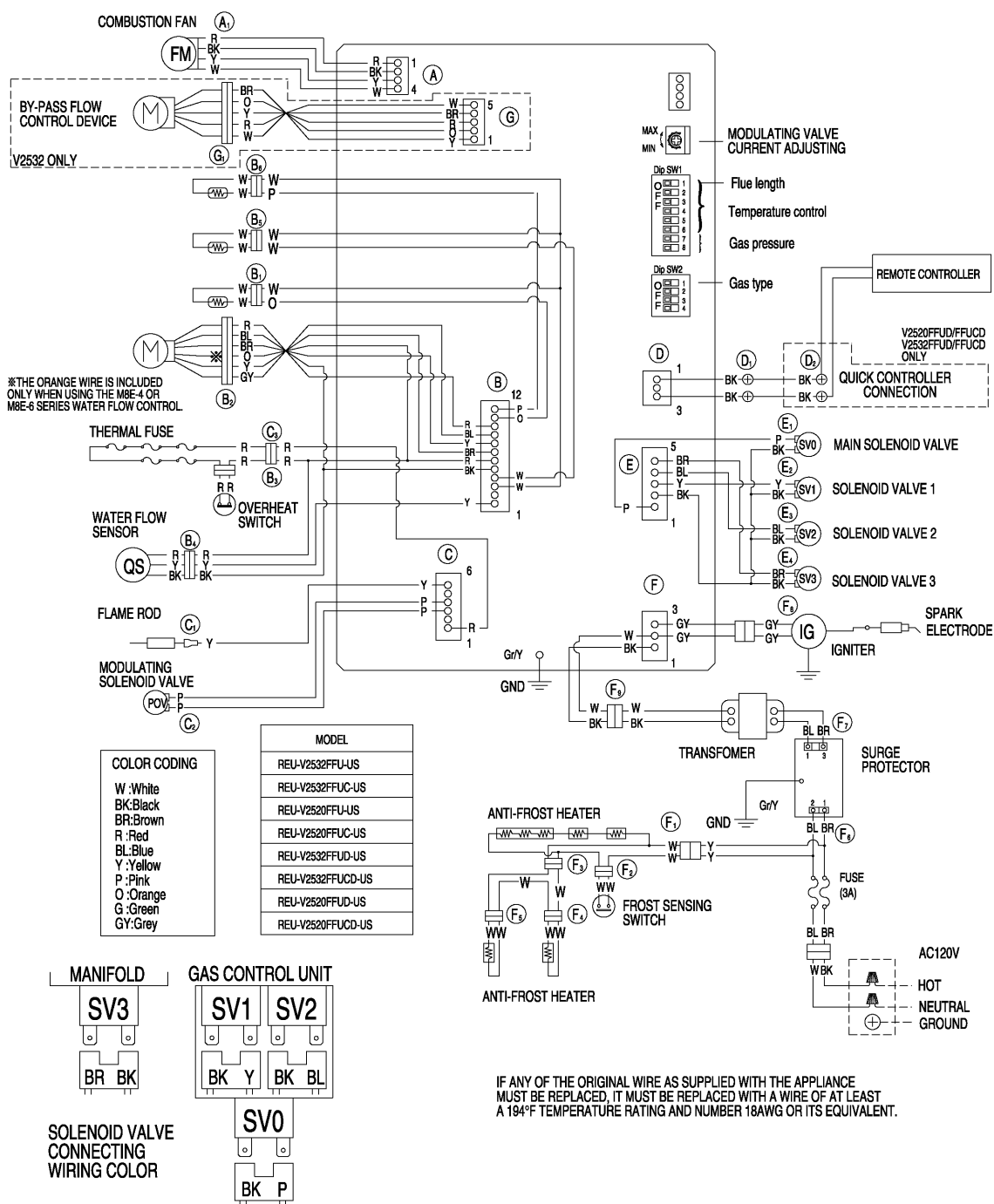

IF ANY OF THE ORIGINAL WIRE AS SUPPLIED WITH THE APPLIANCE MUST BE REPLACED, IT MUST BE REPLACED WITH A WIRE OF AT LEAST A 194°F TEMPERATURE RATING AND NUMBER 18AWG OR ITS EQUIVALENT.



070 00012 31445 7

REU-V2532FFUD-US
REU-V2532FFUCD-US
REU-V2520FFUD-US
REU-V2520FFUCD-US

U245-3245 (01)