

GB100W

NATURAL OR PROPANE GAS BOILER

INSTALLATION & OPERATING

INSTRUCTIONS



DESIGNED AND TESTED ACCORDING TO A.S.M.E. **BOILER AND PRESSURE VESSEL CODE, SECTION IV** FOR MAXIMUM ALLOWABLE WORKING PRESSURE OF **50 PSI, 345 kPa WATER**

NOTE TO INSTALLING CONTRACTOR: READ THESE INSTRUCTIONS CAREFULLY. THEY WILL SAVE YOU TIME IN ASSEMBLING BOILER PROPERLY.

WARNING: Installation and service must be performed by a qualified installer, service agency or the gas supplier in accordance with all local and national codes. Failure to comply with this warning can result in a fire or explosion causing property damage, personal injury or loss of life!

WARNING: If the information in this manual is not followed exactly, a fire or explosion may result causing property damage, personal injury or loss of life.

Do not store or use gasoline or other flammable vapors and liquids in the vicinity of this or any other appliance.

What to do if you smell gas:

- Do not try to light any appliance.
- Do not touch any electrical switch. Do not use any phone in your building.
- Immediately call your gas supplier from a neighbor's phone. Follow the gas supplier's instructions.
- If you cannot reach your gas supplier, call the fire department.

Installation and service must be performed by a qualified installer, service agency or the gas supplier.

INSTALLER, THESE INSTRUCTIONS TO BE AFFIXED ADJACENT TO THE BOILER. CONSUMER, RETAIN THESE INSTRUCTIONS FOR FUTURE REFERENCE PURPOSES.

Smith
CAST IRON BOILERS

WESTCAST, INC.
260 NORTH ELM STREET WESTFIELD, MA 01085
TEL. (413) 562-9631 FAX (413) 562-3799

In Canada: 7555 Tranmere Drive, Mississauga, Ont. L5S 1L4 (905) 672-2991 Fax (905) 672-2883

**GB100W NATURAL OR PROPANE BOILER
INSTALLATION AND OPERATING INSTRUCTIONS**

AVERTISSEMENT. Assurez-vous de bien suivre les instructions données dans cette notice pour réduire au minimum le risque d'incendie ou d'explosion ou pour éviter tout dommage matériel, toute blessure ou la mort

Ne pas entreposer ni utiliser d'essence ou ni d'autres vapeurs ou liquides inflammables à proximité de cet appareil ou de tout autre appareil.

QUE FAIRE SI VOUS SENTEZ UNE ODEUR DE GAZ:

- **Ne pas tenter d'allumer d'appareil.**
- **Ne touchez à aucun interrupteur; ne pas vous servir des téléphones se trouvant dans le bâtiment.**
- **Appelez immédiatement votre fournisseur de gaz depuis un voisin. Suivez les instructions du fournisseur.**
- **Si vous ne pouvez rejoindre le fournisseur, appelez le service des incendies.**

L'installation et l'entretien doivent être assurés par un installateur ou un service d'entretien qualifié ou par le fournisseur de gaz.

CONTENTS

Getting Started	page 2
Boiler Ratings & Capacities	page 3
Locating the Boiler	page 3
Combustible Floor Option	page 5
Air for Combustion	page 5
Chimney & Vent Pipe Connections	page 6
Heating System Piping	page 8
Gas Supply Piping	page 11
Electrical Wiring	page 12
Starting the Boiler	page 18
Operating the Boiler	page 20
Checking & Adjusting	page 23
Boiler Maintenance	page 24
Instructions to the Owner	page 25
Replacement Parts	page 26
Canadian Supplement	page 28
Health Warnings	page 30

BEFORE YOU START

WARNING: This manual must be read and fully understood before installing, operating or servicing this boiler! Failure to follow these instructions could result in a fire or explosion causing extensive property damage, personal injury or death!

These instructions cover the GB100W gas fired, low pressure, sectional, cast iron hot water boiler. GB100W boilers have been design certified by CSA under the latest revision of ANSI-Z21.13 for gas fired low pressure steam and hot water boilers, for use with natural and propane gas. Each unit has been constructed and hydrostatically tested for a maximum working pressure of **50 psi, 345 kPa** in accordance with the A.S.M.E. Boiler and Pressure Vessel Code, Section IV for cast iron boilers. Each boiler has been equipped with a 30 psi pressure relief valve.

This manual covers the application, installation, operation and maintenance of a GB100W low pressure hot water boiler.

To obtain the safe, dependable, efficient operation and long life for which this boiler was designed, these instructions must be read, understood and followed.

Direct all questions to your Smith Cast Iron Boiler distributor or write to the Customer Service Department, 260 North Elm Street, Westfield, MA 01085. Always include the model and serial numbers from the rating plate of the boiler in question.

The owner should maintain a record of all service work performed with the date and a description of the work done. Include the name of the service organization for future reference.

Where required by the authority having jurisdiction, the installation must conform to the Standard for Controls and Safety Devices for Automatically Fired Boilers, ANSI/ ASME CSD-1.

The installation must conform to the requirements of the authority having jurisdiction or, in the absence of such requirements, to the National Fuel Gas Code, ANSI Z223.1/NFPA 54-latest revision. In Canada, installation must be in accordance with the requirements of CAN/CGA B149.1 or 2 Installation Code for Gas Burning Appliances and Equipment.

BOILER RATINGS AND CAPACITIES

Before undertaking the installation of the GB100W check the boiler rating plate to ensure that the boiler is the proper size for the job. The "Net I=B=R Ratings" specify the equivalent amount of direct cast iron radiation that the boiler can handle under normal conditions. Also ensure that the boiler has been set up for the type of gas available at the installation site. Other important considerations are the availability of an adequate electrical supply, fresh air for combustion and a suitable chimney or vent system.

NOTES:

1. For altitudes above **2000 ft, 610 m**, ratings should be reduced at the rate of 4% for each **1000 ft, 305 m** above sea level, 10% in Canada.
2. If ordering a boiler for use with LP gas add a P to the model number, ie PGB100.

BOILER LOCATION

WARNING: This boiler is for installation on non-combustible floors only! A special base supplied by the manufacturer must be used to install this boiler on a combustible floor. Failure to comply with this warning can result in property damage, severe personal injury or death!

1. Locate the boiler in an area that provides good access to the unit. Keep in mind that servicing may require the removal of jacket panels. Accessibility clearances must take precedence over fire protection clearances.
2. An optimum site will be level, central to the piping system, close to a chimney and have adequate fresh air for combustion.
3. Ensure that the floor is structurally sound and will support the weight of the boiler. This boiler is designed for non combustible floors only! A special base supplied by Smith Cast Iron Boilers must be used if the boiler is to be installed on a combustible floor. **NEVER USE A SUBSTITUTE BASE ON A COMBUSTIBLE FLOOR!** Never install this boiler on carpeting!
4. **DO NOT** install this boiler in a location that would subject any of the gas ignition components to direct contact with water or excessive moisture during operation or servicing.
5. **DO NOT** place this boiler in a location that would restrict the introduction of combustion air into the boiler. **NEVER** store objects on or around the boiler.

WARNING Never store combustible materials, gasoline or any product containing flammable vapors or liquids in the vicinity of the boiler. Failure to comply with this warning can result in extensive property damage, severe personal injury or death!

**GB100W NATURAL OR PROPANE BOILER
INSTALLATION AND OPERATING INSTRUCTIONS**

6. If the boiler is to be located in an alcove, closet or other confined space the distances from the boiler and it's vent system to all combustable construction must be equal to or greater than the minimum clearances in Figure 1. When installed in a closet or confined space two permanent openings of equal area adjoining another room or rooms having sufficient volume to meet the requirements of an unconfined space must be provided. Each opening must have a minimum free area of one square inch per **1000 Btu/hr, 2200 mm²/kW** based on the total input rating of all gas utilization equipment in the confined area. Each opening must be no less than **100 in², 64516 mm²**, in size. The upper opening must be within **12 in, 305 mm**, of, but not less than **3 in, 76 mm**, from the top of the enclosure. The bottom opening must be within **12 in, 305 mm**, of, but not less than **3 in, 76 mm**, from the bottom of the enclosure.

WARNING: Never install a PGB100W, propane boiler in a closet or other confined or enclosed space unless the installation conforms to the latest revision of the National Fuel Gas Code, ANSI Z223.1 and all applicable local building codes! Failure to comply with this WARNING could result in a fire or explosion causing extensive property damage, severe personal injury or death!

Figure 1: Clearances to Combustible Construction

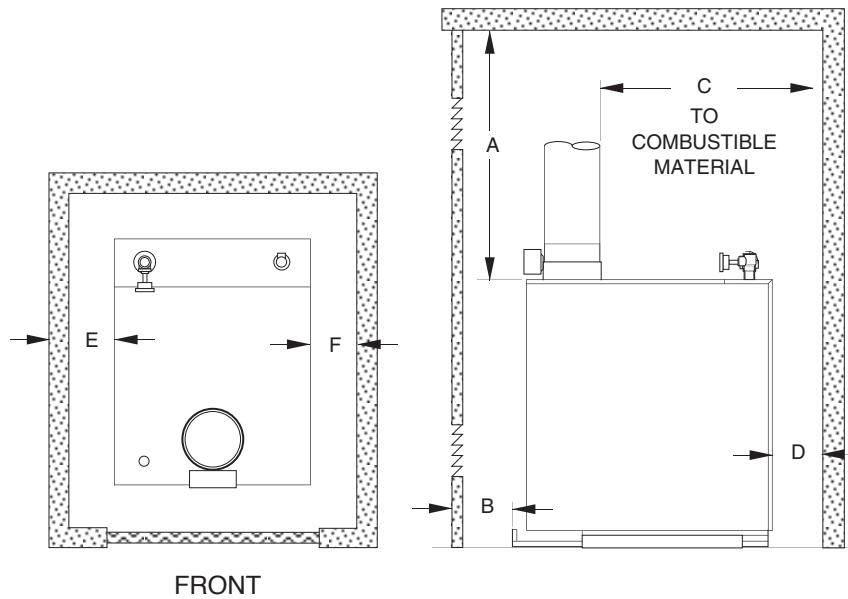

	AL		CL		For Servicing	
	in	mm	in	mm	in	mm
A	24	610	51	1295	N/A	N/A
B	*	*	2	51	N/A	N/A
C	6	152	6	152	6	152
D	4	102	4	102	4	102
E	7	178	7	178	10	254
F	4	102	4	102	10	254

AL = Alcove
 CL = Closet
 *No Front Wall in Alcove

COMBUSTIBLE FLOOR OPTION

The GB100W boiler has been designed for use on noncombustible floors only. If a GB100W boiler is to be installed on combustible flooring of any type, it **MUST** be installed using the Special Base designed by the Smith Cast Iron Boiler Co. Do NOT use any base other than the one specifically designed for it if installing a GB100W boiler on combustible flooring.

WARNING: Never install a GB100W boiler on combustible flooring without using the special base specifically designed for it by the Smith Cast Iron Boiler Co. Do not alter in any way the special base supplied by the Smith Cast Iron Boiler Co. Failure to comply with this warning may result in a fire causing property damage, personal injury or death!

To order the Special Base contact the nearest Smith Cast Iron Boiler distributor and ask for the "Noncombustible Floor Pan".

Determine where the boiler will be located by following the instructions in the Boiler Location section of this manual. Place the Special Base in this location and fasten it in place to prevent it from moving while the boiler is being placed on it.

If the GB100W is being installed in an alcove or closet ensure that the minimum distance to combustible construction requirements, listed in Figure 1, are met.

Remove the sheet metal base pan attached to the boiler. Position the boiler in front of the Special Base. It's suggested that two lengths of 3" pipe the width of the boiler, or longer, be placed under the boiler base side panels.

CAUTION: Be careful not to damage the burners, pilot assembly or any other gas train components during this procedure. If a component is damaged, replace it!

Carefully roll the boiler up to the front of the Special Base. Align the boiler base side panels with the Special Base support channels. Using great care, slide the boiler onto the Special Base.

CAUTION: Never lift the boiler by the jacket panels or flue collector/draft diverter or severe damage to the boiler may result!

Center the boiler from side to side on the Special Base. Ensure that the back of the burner base side panels are flush with the back of the Special Base support channels. Install the front grill supplied with the Special Base. Complete the installation in accordance with the instructions set forth in this manual.

Figure 2: Special Base Installation on Combustible Flooring

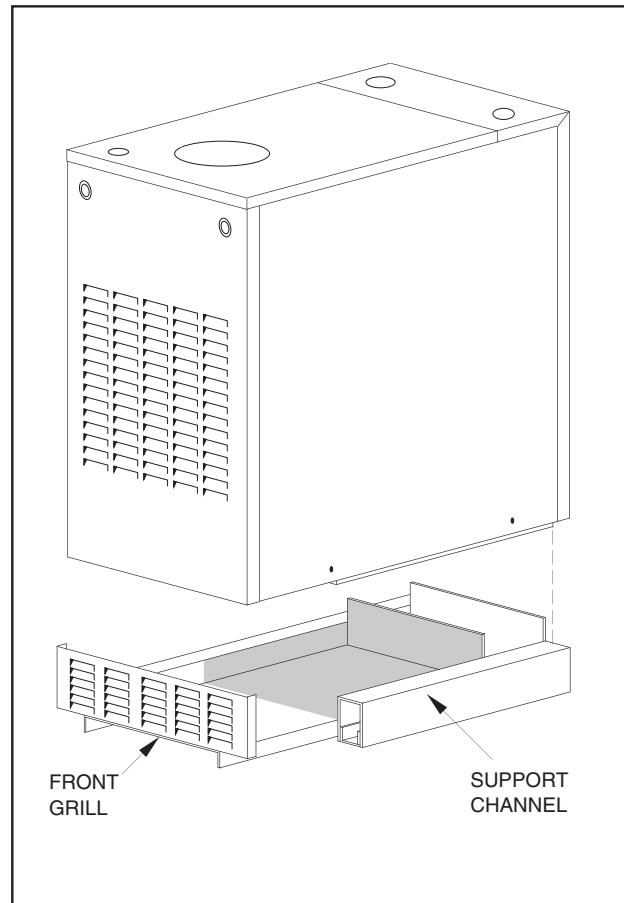

COMBUSTION AIR

WARNING: This boiler must be supplied with combustion air in accordance with Section 5.3, Air for Combustion & Ventilation, of the latest revision of the National Fuel Gas Code, ANSI Z223.1/NFPA 54 and all applicable local building codes. Failure to provide adequate combustion air for this appliance can result in excessive levels of carbon monoxide which can result in severe personal injury or death!

Table 1: Vent and Chimney Dimensions

Boiler Size (Sections)	3	4	5	6	7	8	9	10	11	12
Vent Pipe Dia. (In.)	5	5	6	6	7	7	8	8	9	9
Chimney Flue Size	8 x 8					8 x 12				
Chimney Height (Ft.)	18	18	18	17	17	17	16	16	16	16

GB100W NATURAL OR PROPANE BOILER INSTALLATION AND OPERATING INSTRUCTIONS

To operate properly and safely this boiler requires a continuous supply of air for combustion. Oxygen is used by the burners in the boiler to burn the gas. In addition, air is also used to assist in the safe disposal of the products of combustion. This air is known as dilution air and mixes with the products of combustion to assist in its exit through the flue pipe and chimney. An adequate supply of outside air must be available to replace that used by these processes.

Older houses often have enough "leakage" to provide an adequate amount of combustion air provided that the demand for combustion air is not too great. Homes that are relatively new or "tight" will most likely require the installation of a fresh air duct or other means of providing air for combustion. Any home utilizing other gas burning appliances, a fireplace, wood stove or any type of exhaust fan must be checked for adequate combustion air when all of these devices are in operation at one time. Sizing of an outside air duct must be done to meet the requirements of all such devices.

Table 2: Combustion Air Duct Sizing

Fresh Air Duct Size	Input Btuh 1/4" Wire Mesh Screen	Input Btuh Metal Louvers	Input Btuh Wooden Louvers
3" x 12"	144,000	108,000	36,000
8" x 8"	256,000	192,000	64,000
8" x 12"	384,000	288,000	96,000
8-1/2" x 16"	512,000	384,000	128,000

If the boiler will be located in an alcove, closet or any confined space refer to item 6 in the Boiler Location section of this manual.

CHIMNEY & VENT PIPE CONNECTIONS

WARNING: This boiler must be vented in accordance with Part 7, Venting of Equipment, of the latest revision of the National Fuel Gas code, ANSI Z223.1/NFPA 54 and all applicable local building codes. Improper venting of this appliance can result in excessive levels of carbon monoxide which can result in severe personal injury or death!

Chimney Inspection & Sizing

If this boiler will be connected to a masonry chimney, a thorough inspection of the chimney must be performed. Ensure that the chimney is clean, properly constructed and properly sized. Table 1 lists the flue size and chimney height required for this boiler.

When more than one appliance is connected to the same chimney flue, the flue must be large enough to handle both appliances.

The vent installation must be in accordance with Part 7 of the latest revision of the National Fuel Gas Code, ANSI Z223.1/NFPA 54.

WARNING : If an appliance using any type of a mechanical draft system operating under positive pressure is connected to a chimney flue, never connect any other appliances to this flue. Doing so can result in the accumulation of carbon monoxide which can cause severe personal injury or death!

VENT CONNECTIONS

Always use a type B or C vent pipe of the proper diameter for the boiler. Use the shortest, straightest vent system possible for the particular application. The vent system should be sloped up toward the chimney at a rate of **1/4 in/ft, 2 mm/m**. Ensure that the flue pipe is properly supported and each connection securely fastened with at least 3 corrosion resistant sheet metal screws. The termination of the vent pipe should be flush with the inside of the chimney flue.

Always provide a minimum clearance of **6 in, 152 mm**, between type C vent pipe and any combustible materials. Type B1 vent may be used, clearance between it and any combustible material must be as listed.

WARNING: Failure to maintain minimum clearances between vent connectors and any combustible material can result in extensive property damage, severe personal injury or death!

WARNING: Never modify or alter any part of the draft hood or vent damper supplied with this boiler. This includes the removal or alteration of any baffles in the draft hood or flue collar. Never install a vent pipe of a diameter different than that of the boiler draft hood flue collar, table 1. Failure to comply with this warning can result in severe personal injury or death.

Common Vent Systems

If an existing appliance is removed from a common venting system, the common venting system may then be too large for the proper venting of the remaining appliances connected to it. At the time of removal of an existing boiler, the following steps shall be followed with each appliance remaining connected to the common venting system placed in operation, while the other appliances remaining connected to the common venting system are not in operation.

Au moment du retrait d'une chaudière existante, les mesures suivantes doivent être prises pour chaque appareil toujours raccordé au système d'évacuation commun et qui fonctionne alors que d'autres appareils toujours raccordés au système d'évacuation ne fonctionnent pas: système d'évacuation.

- a) Seal all unused openings in the common vent system and repair any leaks.

Sceller toutes les ouvertures non utilisées du système d'évacuation.

- b) Visually inspect the vent system to ensure that it is properly pitched and sized and that there are no structural deficiencies such as blockages, restrictions, leakage, or corrosion that could cause an unsafe condition.

Inspecter de façon visuelle le système d'évacuation pour déterminer la grosseur et l'inclinaison horizontale qui conviennent et s'assurer que le système est exempt d'obstruction, d'étranglement de fuite, de corrosion et autres défaillances qui pourraient présenter des risques.

- c) As far as is practical close all doors and windows common to the space in which the vent system and appliances connected to the common vent system are contained. Turn on all exhaust fans, clothes dryers, range hoods and appliances requiring air for combustion that are not connected to the common vent system. Ensure that all appliances operate at maximum speed. Do not operate a summer exhaust fan. Close all fireplace dampers.

Dans la mesure du possible, fermer toutes les portes et les fenêtres du bâtiment et toutes les portes entre l'espace où les appareils toujours raccordés du système d'évacuation sont installés et les autres espaces du bâtiment. Mettre en marche les sècheuses, tous les appareils non raccordés au système d'évacuation commun et tous les ventilateurs d'extraction comme les hottes de cuisinière et les ventilateurs des salles de bain. S'assurer que ces ventilateurs fonctionnent à la vitesse maximale. Ne pas faire fonctionner les ventilateurs d'été. Fermer les registres des cheminées.

- d) Place in operation the appliance being inspected. Follow the lighting instructions. Adjust thermostat so appliance will operate continuously.

Mettre l'appareil inspecté en marche. Suivre les instructions d'allumage. Régler le thermostat de façon que l'appareil fonctionne de façon continue.

- e) Test for spillage at the draft hood relief opening after 5 minutes of main burner operation. Use the flame of a match or candle, or smoke from a cigarette, cigar or pipe.

Faire fonctionner le brûleur principal pendant 5 min ensuite, déterminer si le coupe-tirage déborde à l'ouverture de décharge. Utiliser la flamme d'une allumette ou d'une chandelle ou la fumée d'une cigarette, d'un cigare ou d'une pipe.

- f) After it has been determined that each appliance remaining connected to the common venting system properly vents when tested as outlined above, return doors, windows, exhaust fans, fireplace dampers and any other gas-burning appliance to their previous condition of use.

Une fois qu'il a été déterminé, selon la méthode indiquée ci-dessus, que chaque appareil raccordé au système d'évacuation est mis à l'air libre de façon adéquate. Remettre les portes et les fenêtres, les ventilateurs, les registres de cheminées et les appareils au gaz à leur position originale.

- g) Any improper operation of the common venting system should be corrected so the installation conforms with the National Fuel Gas Code, ANSI Z223.1/NFPA 54. When resizing any portion of the common venting system, the common venting system should be resized to approach the minimum size as determined using the appropriate tables in Appendix F in the National Fuel Gas Code, ANSI Z223.1/NFPA 54 and or CSA B149 Installation Codes.

Tout mauvais fonctionnement du système d'évacuation commun devrait être corrigé de façon que l'installation soit conforme au National Fuel Gas Code, ANSI Z223.1/NFPA 54 et (ou) aux codes d'installation CSA-B149. Si la grosseur d'une section du système d'évacuation doit être modifiée, le système devrait être modifié pour respecter les valeurs minimales des tableaux pertinents de l'appendice F du National Fuel Gas Code, ANSI Z223.1/NFPA 54 et (ou) des codes d'installation CSA-B149.

Vent Dampers

This boiler comes from the factory equipped with a vent damper specifically engineered for it. The vent damper must be properly installed to obtain the high performance for which this boiler was designed. If the damper is damaged or missing do not install the boiler without it! Contact the nearest Smith Cast Iron Boilers distributor to obtain the proper vent damper.

WARNING: On boilers with a constant pilot ignition system, ensure that the hole in the damper blade is not plugged. Failure to do this could result in the spillage of carbon monoxide which can result in severe personal injury!

Vent dampers are designed for use with only one appliance. NEVER connect more than one appliance to a single vent damper.

Locate the vent damper so that it is accessible and the damper position indicator is visible. Maintain a minimum of 6 inches between the damper and any combustible materials!

GB100W NATURAL OR PROPANE BOILER INSTALLATION AND OPERATING INSTRUCTIONS

Fasten the vent damper to the flue collar and vent pipe using at least 3 corrosion resistant sheet metal screws per joint. Connect the damper harness to the top panel with the BX connector supplied. Plug the Molex connector on the damper harness into the mating plug on the harness located inside the control compartment.

The vent damper is operating properly when it opens completely upon a call for heat and closes completely when the call for heat ends. The vent damper must be in the open position when the boiler's main burners are in operation.

Figure 3: Vent Damper Location

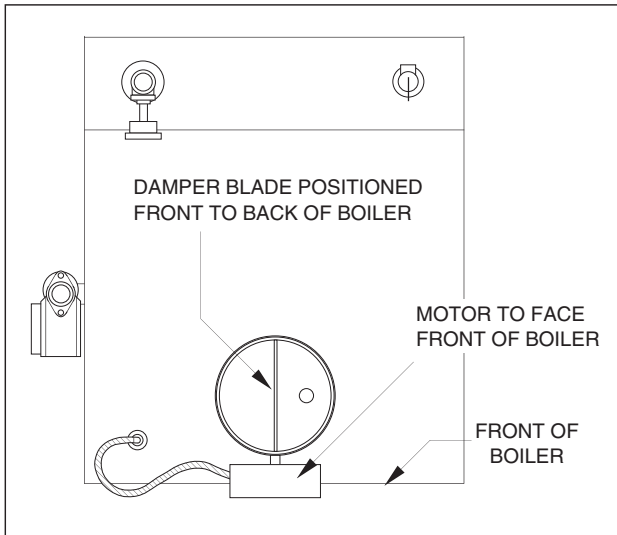

HEATING SYSTEM PIPING

CAUTION: All piping must be installed by a qualified technician in accordance with the provisions set forth in the applicable ANSI/ASME standards and local building codes and regulations. Improper piping of this boiler can cause flooding, extensive property damage, heating system damage or damage to the boiler.

The GB100W hot water boiler comes from the factory ready to be piped to the heating system. Each boiler is equipped with a safety relief valve. This valve must be piped in accordance with the ANSI/ASME Boiler and Pressure Vessel Code, Section IV. Figure 4 provides a pictorial description of the boiler and piping components.

Figure 4: Heating System Piping

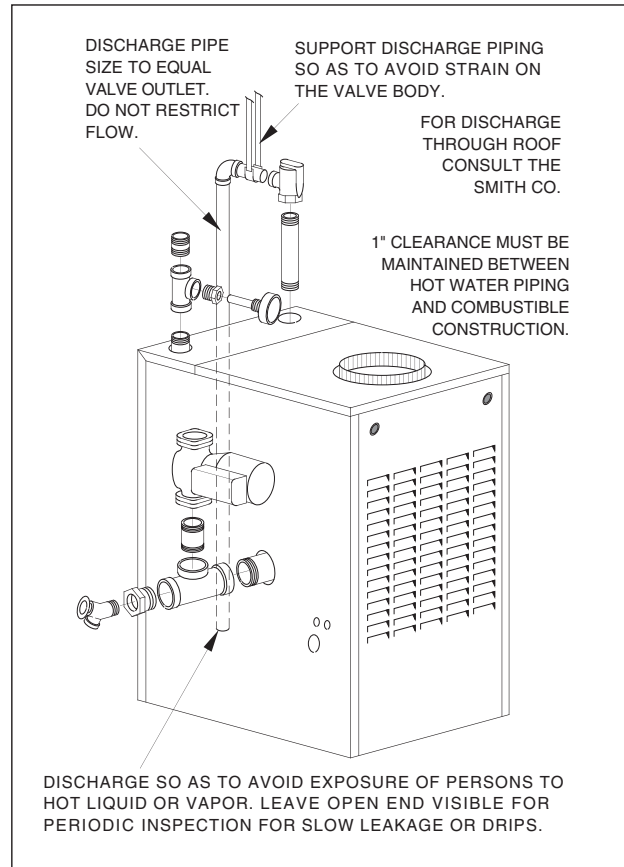

The boiler should be placed in the location selected for it. Refer to the BOILER LOCATION section in this manual. Ensure that the boiler is level from front to back and from side to side. Use metal shims to level the boiler. NEVER use wood, plastic or other combustible materials as shims.

All heating system piping must be installed in accordance with the ANSI/ASME Boiler and Pressure Vessel Code, Section IV, and ANSI/ ASME CSD-1, Standard for Controls and Safety Devices for Automatically Fired Boilers. All applicable local codes and ordinances must also be followed.

If the boiler is installed above any radiation elements it must be fitted with a low water cutoff device, L.W.C.O., installed above the normal boiler water level.

Circulators

A TACO 007 circulator has been supplied as standard equipment with the boiler. The 007 is sized for use in a closed heating system with a **30 psi, 207 kPa**, maximum operating pressure. If the 007 circulator furnished with this boiler does not have the required capacity for the system in which it is to be installed, an extra zone circulator must be provided. A circulator with a higher capacity may also be used. Figure 5 depicts the performance curve for the TACO 007 circulator.

Piping For Use With Cooling Units

The boiler, when used in connection with a refrigeration system, must be installed so the chilled medium is piped in parallel with the boiler. Appropriate valves must be used to prevent the chilled water from entering the boiler. See Figure 6 for the proper piping layout.

When a boiler is connected to a heating coil that may be exposed to refrigerated air from an air handling device, the piping system must be equipped with flow-control valves or some other automatic means of preventing gravity circulation of the boiler water during the cooling cycle.

Figure 5: TACO 007 Performance Curve

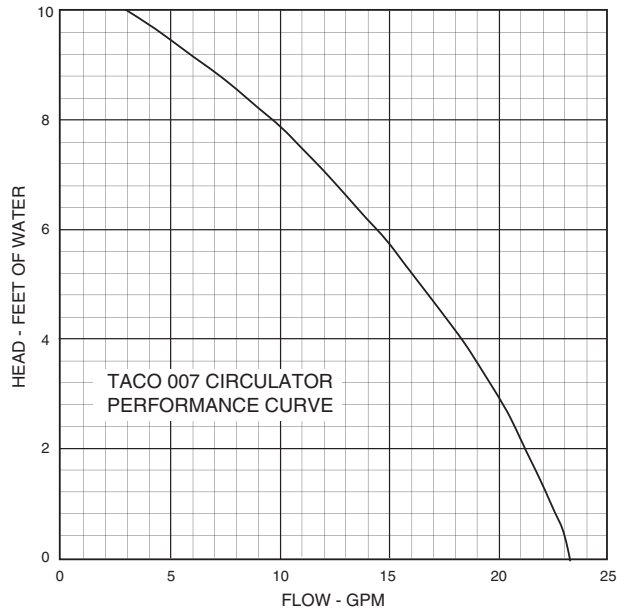

**GB100W NATURAL OR PROPANE BOILER
INSTALLATION AND OPERATING INSTRUCTIONS**

CAUTION: To prevent damage due to excessive condensation, one of the following piping options should be used.

System Bypass

For systems using a circulator on the return as either a single zone, or multiple zones with zone valves, install a system bypass line between the supply and return on the suction side of the circulator, see Figure 7. Install a metering valve in this bypass line to regulate the amount of flow that will be diverted to the return. A plug valve offers the best control for this application. Although other valves may be less expensive, a plug valve will be easier to set accurately.

In the absence of a flow indicator, set the metering valve using temperature as a guide. The accompanying diagram suggests one scenario. This addition requires only two tees, a plug valve, and a small amount of pipe and offers the simplest approach to reliably control condensation. For this system and those that follow, be aware that you are using a percentage of the pump capacity to blend, but the friction loss for the entire pump flow has been reduced. In most cases, the standard pump packaged with the boiler has enough capacity to feed the baseboard distribution system and the bypass line.

Figure 7: System Bypass

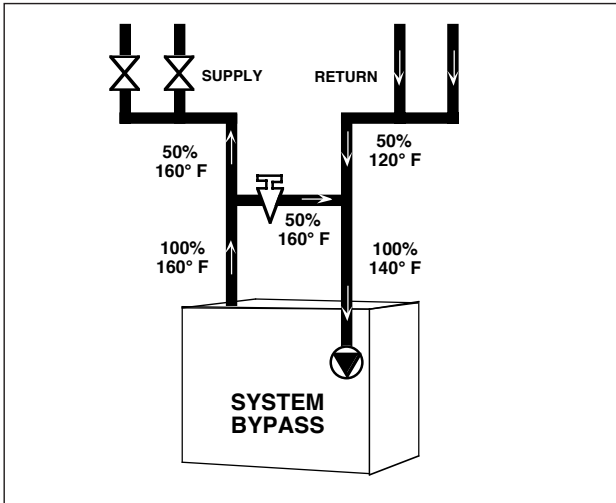

Pump Away Bypass

For systems that use a single circulator to pump away from the boiler, the bypass should be installed on the discharge side of the circulator, see Figure 8. Full temperature water supplies the baseboard distribution system as before. Half of the circulator's volume moves through the bypass, blending and heating the cooler return water. Again, the cost of installing the bypass is small and setting it by temperature can be accomplished with a contact thermometer.

Figure 8: Pump Away Bypass

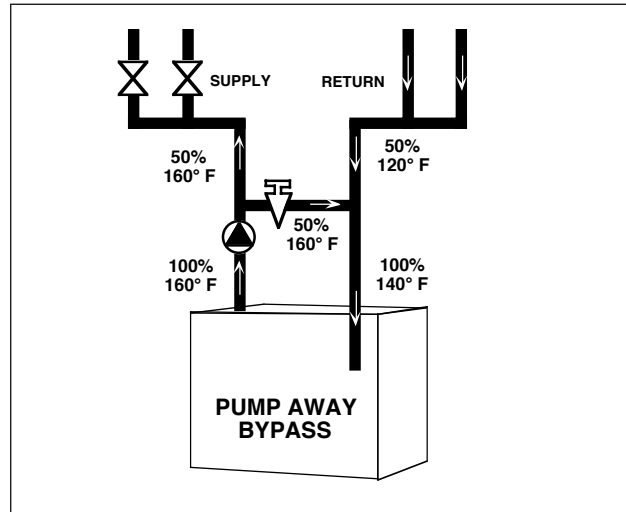

Pumped Blend

An additional circulator can also be used to provide a return water temperature blend. This method works well with systems with multiple zones with circulators, see Figure 9. The dedicated bypass circulator provides a strong blending flow without diminishing the flow available to any heating zone. Any residentially sized circulator is adequate for this purpose.

Each of these bypass solutions also has the added benefit of increasing circulation in the boiler which will maximize tankless coil output and increase the accuracy of temperature sensing controls.

Figure 9: Pumped Bypass

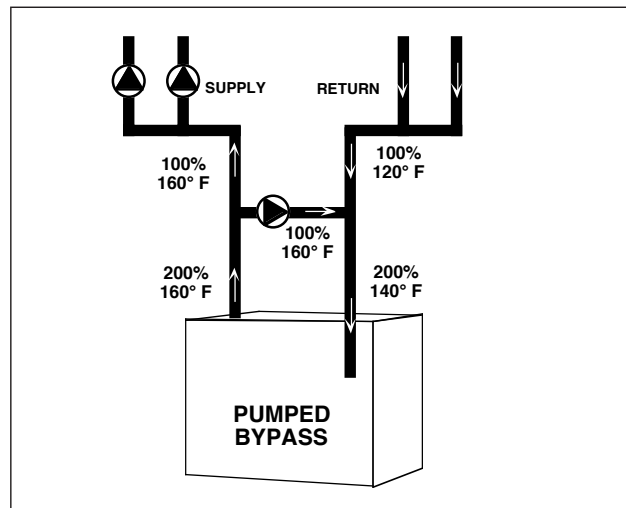

Reverse Acting Aquastats

An alternative for existing systems experiencing condensation that does not require re-piping the boiler utilizes a reverse acting aquastat, one that makes on temperature rise. This approach works best in single zone systems. Wired in series with the circulator, this control holds the circulator off until the boiler reaches an acceptable temperature and then starts system circulation, see Figure 10.

The most commonly available reverse acting aquastat is a Honeywell L4006B. The aquastat should be mounted in an immersion well directly installed in the boiler. The use of heat conductive grease, Honeywell part # 972545, in the immersion well is strongly recommended for fast and accurate temperature response. Set this adjustable aquastat to make at no less than **130° F, 54°C**. While this method can cause the circulator to cycle more frequently, setting the aquastat's differential to the maximum 25-30°F will minimize short cycling.

Figure 10: Reverse Aquastat

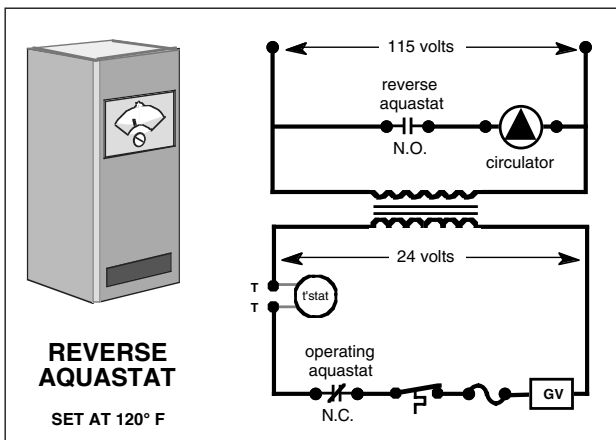

GAS SUPPLY PIPING

WARNING: All gas piping must be installed by a qualified technician in accordance with the provisions set forth in the latest revision of ANSI Z223.1 and all applicable local building codes and regulations. All LP gas connections must be made by a licensed propane installer. Failure to comply with this WARNING can result in extensive property damage, severe personal injury or death!

The GB100W hot water boiler comes from the factory ready to be piped to the gas supply.

WARNING: Check the boiler rating plate to make sure that the boiler is for the type of gas that will be used. If it isn't, do not connect the boiler to the gas supply. Failure to comply with this warning can result in extensive property damage, severe personal injury or death!

If for any reason the boiler is not for the type of gas available at the installation site, call the nearest Smith Cast Iron Boiler distributor to resolve the problem.

Table 3 should be used to ensure that the gas supply piping is sized properly. If more than one appliance is supplied by the same supply pipe, the piping must be sized based on the maximum possible demand. Do not neglect the pressure drop due to pipe fittings. Table 4 should be used in conjunction with Table 3 to ensure that the supply piping has the capacity to meet the demand.

Table 3: Gas Pipe Capacity

Maximum pipe capacity in ft ³ /hr based on 0.60 specific gravity gas at pressure of 0.5 psig or less and a 0.3" W.C. pressure drop.									
Nominal Iron Pipe Size (in.)	Pipe length in feet								
	10	20	30	40	50	60	80	100	150
Maximum gas volume in cubic feet/hr, (ft ³ /hr)									
3/4"	278	190	152	130	115	105	90	79	64
1"	520	350	285	245	215	195	170	150	120
1-1/4"	1050	730	590	500	440	400	350	305	250
1-1/2"	1600	1100	890	760	670	610	530	460	380

Table 4: Equivalent Length Chart

Equivalent length of pipe fittings in feet				
Nominal Iron Pipe Size (inches.)	Type of pipe fitting			
	90° Elbow (flow thru branch)	Tee (full port)	Gate Valve (full port)	Gas Cocks
Equivalent length in feet				
3/4"	2.06	4.12	0.48	1.25
1"	2.62	5.24	0.61	1.60
1-1/4"	3.45	6.90	0.81	2.15
1-1/2"	4.02	8.04	0.94	2.50

GB100W NATURAL OR PROPANE BOILER INSTALLATION AND OPERATING INSTRUCTIONS

Figure 11 depicts the proper way to connect the boiler to the gas supply piping. The manual shut-off valve **MUST** be installed in the supply piping. It should be approximately **5 ft, 1.5 m** above the floor. Provide a drip leg/sediment trap at the bottom of the vertical section of the gas supply pipe. A ground joint union should be installed between the boiler gas controls and the supply piping. Each of these items are needed to ensure long life and ease of servicing. Always use a pipe sealant that is suitable for use with LP gas.

Figure 11: Gas Supply Piping

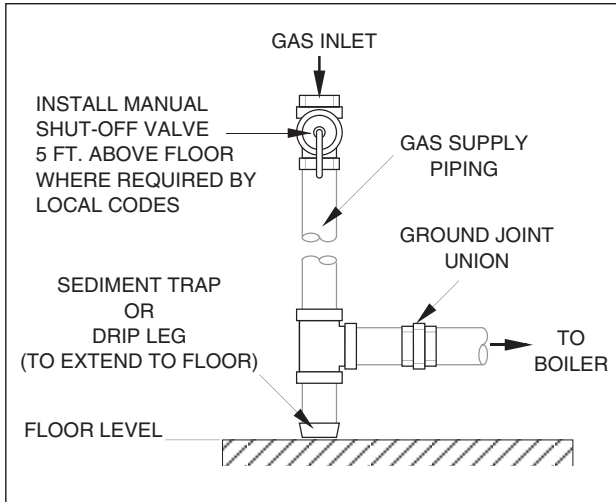

CAUTION: Always use a wrench on the gas valve body when making gas connections to it. Never over-tighten the piping entering the gas valve body. Failure to comply with this caution may result in gas valve failure!

Safe lighting and other performance criteria were met with the gas manifold and control assembly provided on the boiler. All gas connections **MUST** be leak tested before putting the boiler into operation.

WARNING: Never use an open flame to test for gas leaks. Always use an approved leak detection method. Failure to comply with this warning can cause extensive property damage, severe personal injury or death!

Whenever the gas supply piping is pressure tested the boiler gas controls must be protected. If the test pressure is equal to, or less than **1/2 psig, 3.5 kPa**, isolate the boiler by closing its manual shut off valve, see Figure 11. If the test pressure is greater than, or equal to **1/2 psig, 3.5 kPa**, disconnect the boiler and its individual shut-off valve.

ELECTRICAL WIRING

WARNING: All electrical wiring must conform to all applicable local codes and the latest revision of the National Electrical Code, ANSI/NFPA-70. Failure to comply with this warning can result in extensive property damage, personal injury or death!

Electrical Power Connections

CAUTION: Label all wires prior to disconnection when servicing controls. Wiring errors can cause improper and dangerous operation!

ATTENTION: Au moment de l'entretien des commandes, étiquetez tous les fils avant de les débrancher. Des erreurs de câblage peuvent entraîner un fonctionnement in-adéquat et dangereux. S'assurer que l'appareil fonctionne adéquatement une fois l'entretien terminé.

The electrical connections to this boiler must be made in accordance with all applicable local codes and the latest revision of the National Electrical Code, ANSI/NFPA-70. Installation should also conform with CSA C22.1 Canadian Electrical Code Part I if installed in Canada. Install a separate 120 volt 15 amp circuit for the boiler. A shut-off switch should be located at the boiler. The boiler must be grounded in accordance with the authority having jurisdiction, or if none, the latest revision of the National Electrical Code, ANSI/NFPA-70.

Line voltage field wiring of controls and other devices must conform to the temperature limitation of type T wire at **95°F, 35°C**, above room temperature. Use copper conductors with a minimum size of #14 awg. Low voltage wiring must not be less than #18 awg with a neoprene, thermoplastic or other equivalent insulation having a minimum insulation thickness of **0.012 in, 0.3 mm**.

Thermostat Installation

ALWAYS follow the instructions included with the thermostat to be used to control the boiler. Proper location of the thermostat will ensure efficient trouble-free operation of the boiler. Mount the thermostat to an inside wall at a height approximately five feet above the floor. Avoid placing the thermostat in areas that will not provide an accurate measurement of the room temperature. Locating the thermostat behind a door, in an alcove, close to a source of thermal radiation or in a drafty area will cause poor or sporadic heating.

Vent Damper

The vent damper supplied with the boiler has been wired with a 6 pin molex connector that will plug directly into the boiler's wiring harness.

**GB100W NATURAL OR PROPANE BOILER
INSTALLATION AND OPERATING INSTRUCTIONS**

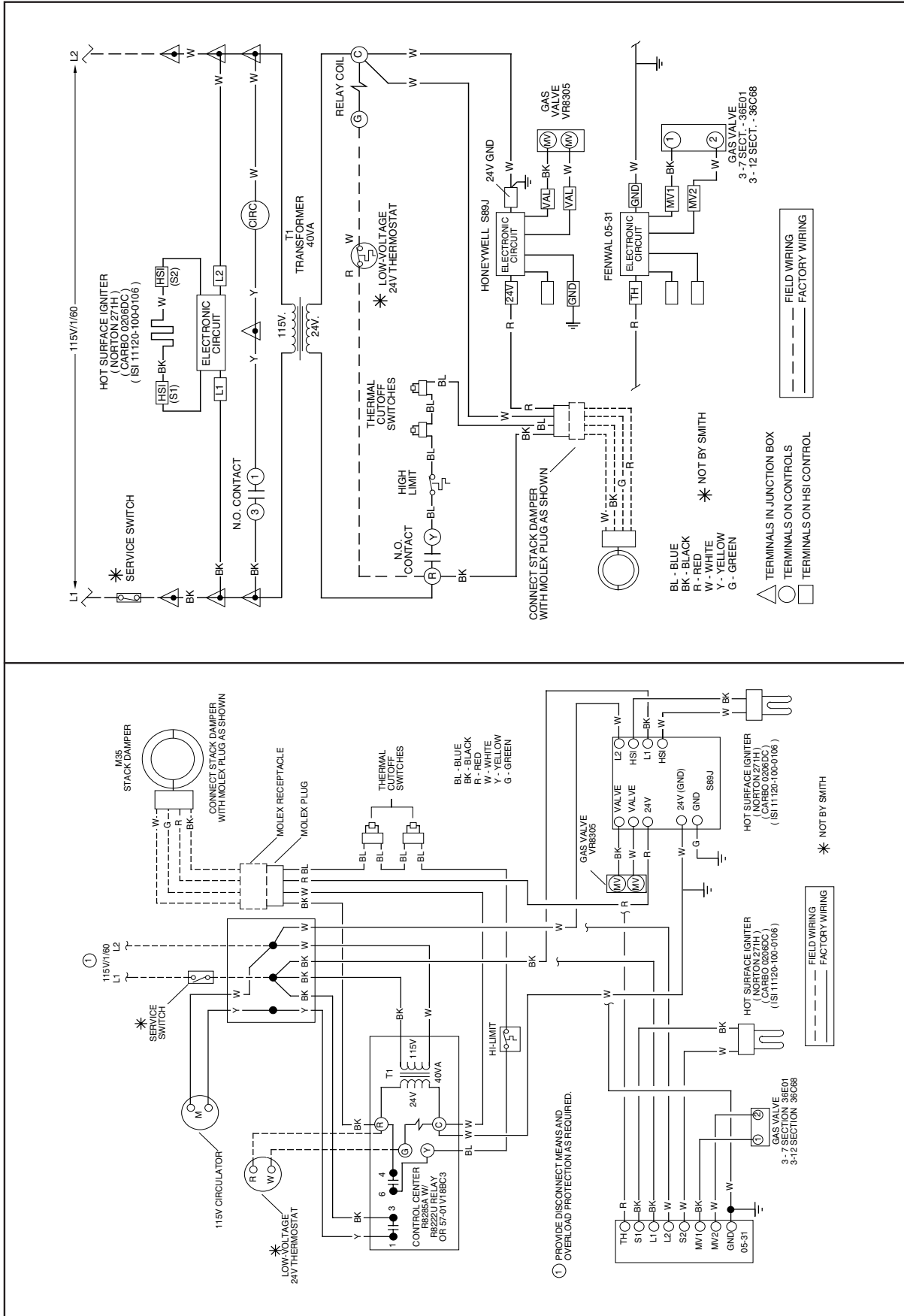
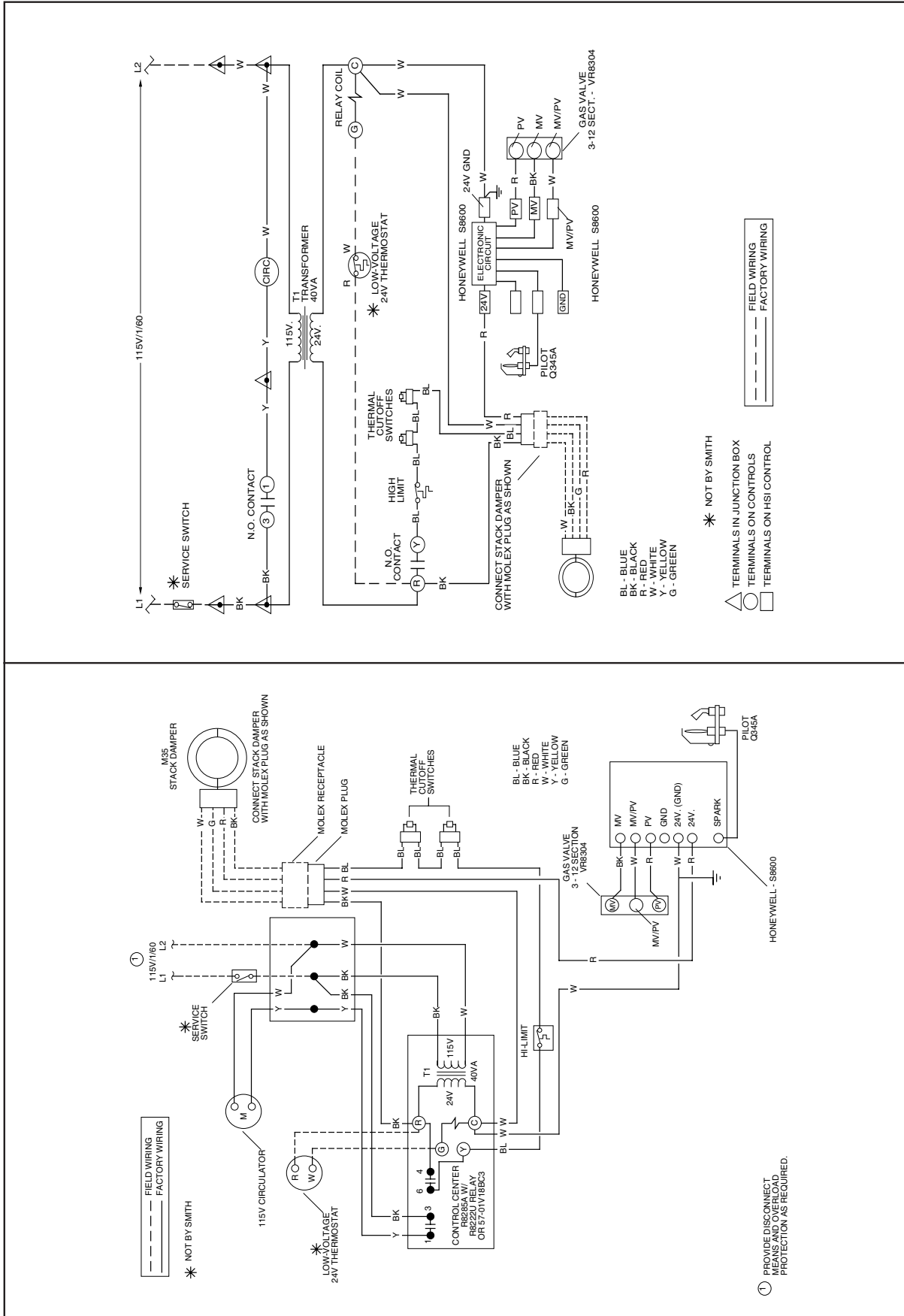

Figure 12: Fenwal/Honeywell Direct Ignition

IF ANY OF THE ORIGINAL WIRE AS SUPPLIED WITH THIS APPLIANCE MUST BE REPLACED, IT MUST BE REPLACED WITH TYPE 105°C THERMOPLASTIC WIRE OR IT'S EQUIVALENT.

GB100W NATURAL OR PROPANE BOILER INSTALLATION AND OPERATING INSTRUCTIONS



IF ANY OF THE ORIGINAL WIRE AS SUPPLIED WITH THIS APPLIANCE MUST BE REPLACED,
IT MUST BE REPLACED WITH TYPE 105°C THERMOPLASTIC WIRE OR IT'S EQUIVALENT.

Figure 13: Honeywell Intermittent Pilot Ignition

**GB100W NATURAL OR PROPANE BOILER
INSTALLATION AND OPERATING INSTRUCTIONS**

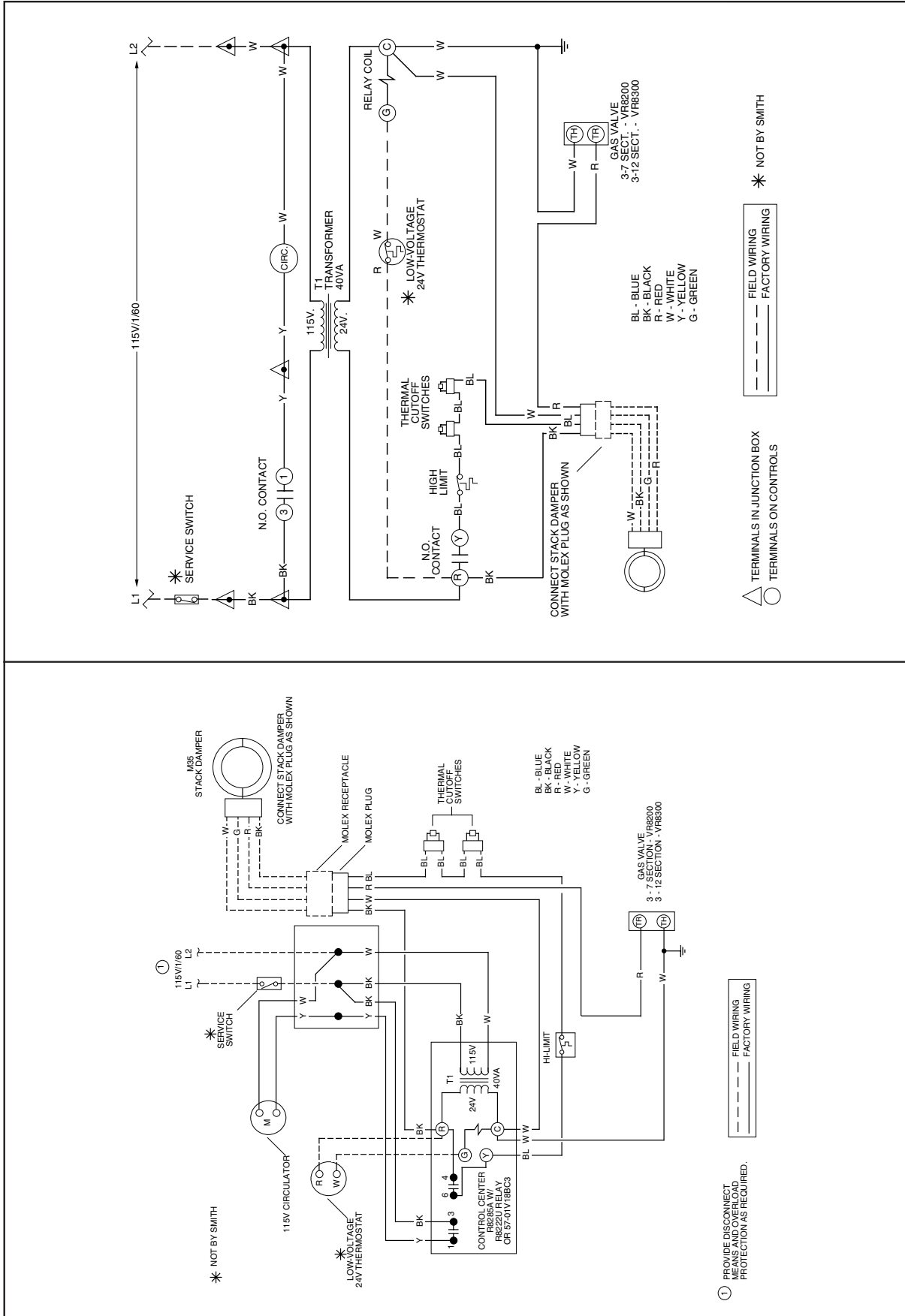

IF ANY OF THE ORIGINAL WIRE AS SUPPLIED WITH THIS APPLIANCE MUST BE REPLACED, IT MUST BE REPLACED WITH TYPE 105°C THERMOPLASTIC WIRE OR IT'S EQUIVALENT.

Figure 14: Honeywell Continuous Pilot Ignition

BOILER SET UP

NOTE: Before starting the boiler, turn off the electrical supply going to it. Make sure that gas is available at the combination control inlet. Open the valves in the return and supply piping. Failure to take these precautions will prevent the boiler from operating properly.

Fill the boiler and all of the radiation with water. Make sure that the system is completely purged of air.

Review these instructions and make sure that the boiler installation complies with ALL of the stated instruction up to this point.

Flame Roll-out Safety Shutoff System

The GB100W gas boiler is fitted with a flame roll-out switch that detects the presence of hot flue gases in the control compartment. If something prevents the combustion products from properly passing through the boiler, the roll-out switch will shut the boiler off. If the flame roll-out safety system is activated, contact qualified service agency to correct the problem and reset the flame roll-out safety switch. Do not attempt to start the boiler until problem has been corrected and the switch has been reset.

Never attempt to bypass the flame roll-out safety shutoff switch for the purpose of operating the boiler!

The boiler should be inspected and serviced before each heating season by a qualified service agency. The boiler flue passages, venting system, ignition components and the burners should be cleaned and examined for deterioration due to corrosion. All operational characteristics of the boiler such as combustion products, the ignition safety shutoff devices and proper control function must be thoroughly checked out.

During the heating season, the owner should check the boiler and the area around it at least once a month. Clear away all objects on or near the boiler. Ensure that there is no discoloration of adjacent combustible materials due to heat. If there is, IMMEDIATELY call the installer or a qualified service agency.

**GB100W NATURAL OR PROPANE BOILER
INSTALLATION AND OPERATING INSTRUCTIONS**

FOR YOUR SAFETY READ BEFORE OPERATING



WARNING

If you do not follow these instructions exactly, a fire or explosion may result causing property damage, personal injury or loss of life.

- A. 1. If this appliance is equipped with a pilot that must be lit by hand, follow lighting instructions exactly when lighting the pilot.
2. If this appliance is equipped with an ignition device that automatically lights the pilot or burner, follow operating instruction, do not try to light the pilot or burner by hand.
- B. BEFORE LIGHTING smell all around the appliance area for gas. Be sure to smell next to the floor because some gas is heavier than air and will settle on the floor.
- WHAT TO DO IF YOU SMELL GAS
- Do not try to light any appliance.
 - Do not touch any electric switch; do not use any phone in your building.
- Immediately call your gas supplier from a neighbor's phone. Follow the gas supplier's instructions.
 - If you cannot reach your gas supplier, call the fire department.
- C. Use only your hand to push in or turn the gas control knob. Never use tools. If the knob will not push in or turn by hand, don't try to repair it, call a qualified service technician. Force or attempted repair may result in a fire or explosion.
- D. Do not use this appliance if any part has been under water. Immediately call a qualified service technician to inspect the appliance and to replace any part of the control system and any gas control which has been under water.

LIGHTING INSTRUCTIONS

Continuous Pilot-Honeywell VR8200A and VR8300A (Natural or Propane), VRF8200P and VR8300C (Propane Only)

1. STOP! Read the safety information above.
2. Set the thermostat to lowest setting.
3. Turn off all electric power to the appliance.
4. Remove control access panel.
5. Turn the gas control knob clockwise  to "OFF".
6. Wait five (5) minutes to clear out any gas. Then smell for gas, including near the floor. If you smell gas, STOP! Follow "B" in the safety information above. If you don't smell gas, go to the next step.
7. Remove the pilot access panel located just above the burner tubes.
8. The pilot's located behind this panel.
9. Turn the knob on the gas control counterclock-wise  to "PILOT".
10. Push and hold down the red button next to the control knob. Light the pilot with a match and wait approximately one (1) minute before releasing the button. The button should pop back and the pilot remain lit. If it goes out repeat steps 5 - 10.
*If the button does not pop up when released, stop and immediately call your service technician or gas supplier.
*If the pilot will not stay lit after several tries, turn the gas control knob to "OFF" and call your service technician or gas supplier.
11. Replace the pilot access panel.
12. Turn the gas control knob counterclock-wise  to "ON".
13. Replace control access panel.
14. Turn on all electric power to the appliance.
15. Set thermostat to desired setting.
16. If the appliance will not operate, follow the instructions "TO TURN OFF GAS TO APPLIANCE" and call your service technician or gas supplier.

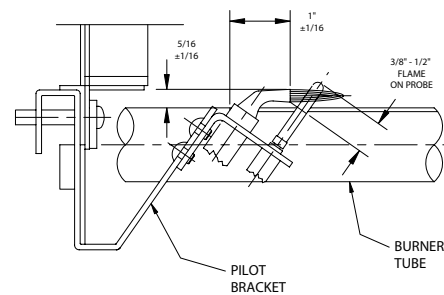
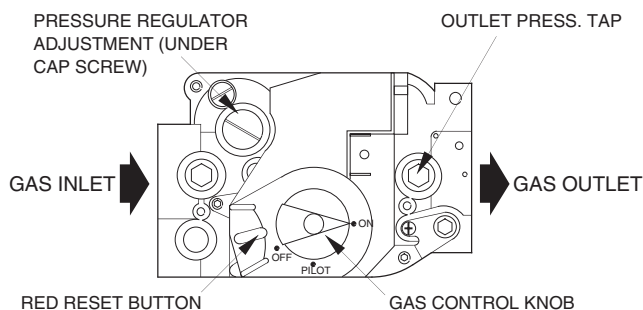

CONTINUOUS PILOT

POUR VOTRE SÉCURITÉ LISEZ AVANT D'ALLUMER

AVERTISSEMENT. Quiconque ne respecte pas à la lettre les instructions dans la présente notice risque de déclencher un incendie ou une explosion entraînant des dommages, des blessures ou la mort.

A. Cet appareil est muni d'une veilleuse qui doit être allumée manuellement. Respectez les instructions cidessous à la lettre.

B. Avant d'allumer la veilleuse, reniflez tout autour de l'appareil pour déceler une odeur de gaz. Reniflez près du plancher, car certains gaz sont plus lourds que l'air et peuvent s'accumuler au niveau du sol.

QUE PAIRE SI VOUS SENTEZ UNE ODEUR DE GAZ:

- Ne pas tenter d'allumer d'appareil.
- Ne touchez à aucun interrupteur; ne pas vous servir des téléphones se trouvant dans le bâtiment.
- Appelez immédiatement votre fournisseur de gaz depuis un voisin. Suivez les instructions du fournisseur.

• Si vous ne pouvez rejoindre le fournisseur, appelez le service des incendies.

C. Ne poussez ou tournez la manette d'admission du gaz qu'à la main; ne jamais utiliser d'outil. Si la manette reste coincée, ne tentez pas de la réparer; appelez un technicien qualifié. Le fait de forcer la manette ou de la réparer peut déclencher une explosion ou un incendie.

D. N'utilisez pas cet appareil s'il été plongé dans l'eau, même partiellement. Faites inspecter l'appareil par un technicien qualifié et remplacez toute partie du système de contrôle et toute commande qui ont été plongés dans l'eau.

INSTRUCTIONS D'ALLUMAGE

1. ARRÊTEZ! Lisez les instructions de sécurité sur la portion supérieure de cette étiquette.
2. Réglez le thermostat à la température la plus basse.
3. Coupez l'alimentation électrique de l'appareil.
4. Enlever le panneau de porte du réchauffer.
5. Poussez légèrement la manette de commande de gaz et tournez-la vers la droite jusqu' à la position "OFF".

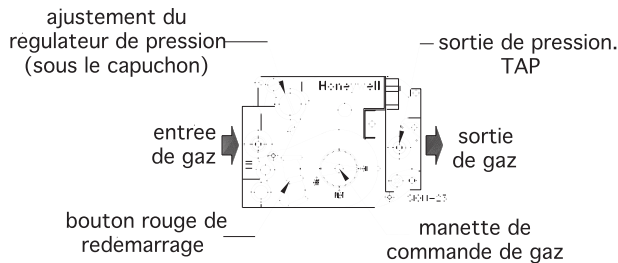

6. Attendre cinq (5) minutes pour laisser échapper tout le gaz. Reniflez tout autour de l'appareil, y compris près du plancher, pour déceler une 'odeur de gaz. Si vous sentez une odeur de gaz, ARRÊTEZ! Passez à l'étape "B" des instructions de sécurité sur la portion supérieure (à gauche) de cette étiquette. S'il n'y a pas d'odeur de gaz, passer à l'étape suivante.
7. Ouvrez la trappe d'observation de la chambre de combustion située au-dessus des brûleurs principaux.

8. Identifiez la veilleuse, suivez le tube métallique de la manette de commande de gaz. La veilleuse se trouve entre les deux tubes de brûleurs derrière la trappe d'observation.

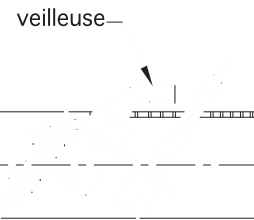

9. Tournez la manette de commande de gaz dans le sens contraire des aiguilles d'une montre jusqu'à la position (Veilleuse).
10. Enfoncez la manette de commande et maintenez-la. Allumez immédiatement la veilleuse avec des allumettes. Continuez à appuyer sur la manette pendant environ 1 minute après l'allumage de la veilleuse. Relâcher la veilleuse et elle reprendra sa position initiale. La veilleuse doit rester allumée. Si elle s'éteint, répétez les étapes de 4 à 9.
 - Si la manette ne se soulève pas d'elle-même lorsqu'on la relâche, arrêtez et appelez immédiatement le technicien ou le fournisseur de gaz.
 - Si la veilleuse ne reste pas allumée après plusieurs tentatives, tournez la manette de commande de gaz sur la position "OFF" et appelez le technicien ou le fournisseur.
11. Refermez la trappe de la chambre d'observation.
12. Déplacez la manette de commande de gaz vers la gauche jusqu' à la position "ON"
13. Rebranchez l'alimentation électrique de l'appareil.
14. Réglez le thermostat à la température désirée.

COMMENT COUPER L'ADMISSION DE GAZ DE L'APPAREIL

1. Mette le thermostat à la température la plus basse.
2. Si un entretien doit être effectué, coupez l'alimentation électrique de l'appareil.
3. Lever le panneau de porte du réchauffer.
4. Tourner le bouton de commande de gaz vers droite, en position d'arrêt "OFF". Ne pas forcer!
5. Replacer le panneau de porte du réchauffer.

**GB100W NATURAL OR PROPANE BOILER
INSTALLATION AND OPERATING INSTRUCTIONS**

OPERATING INSTRUCTIONS

**Intermittent Pilot - WHITE RODGERS 36C & 36E and Honeywell VR8304A (Natural or Propane),
VR8304P (Propane Only)
Direct Ignition - White Rodgers 36C & 36E and Honeywell VR8305A (Natural or Propane),
VR8305P (Propane Only)**

1. STOP! Read the safety information above.
2. Set the thermostat to lowest setting.
3. Turn off all electric power to the appliance.
4. This appliance is equipped with an ignition device which automatically lights the pilot or burner. Do not try to light the pilot or burner by hand!
5. Remove control access panel.
6. Turn the gas control knob clockwise  to the full "OFF" position, on W-R 36C/E push the knob before turning.
7. Wait five (5) minutes to clear out any gas. Then

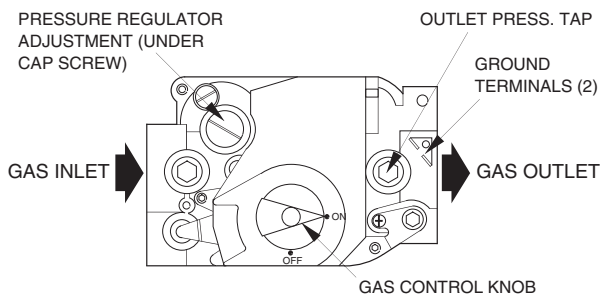

HONEYWELL VR8304A/P

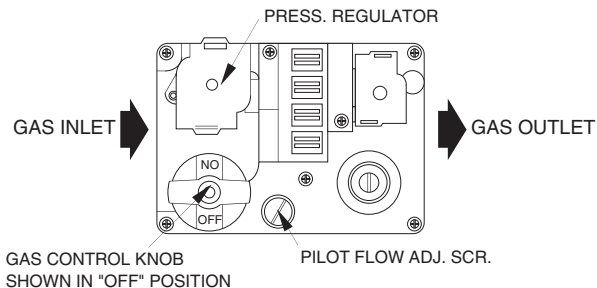

WHITE RODGERS 36E

8. Turn the gas control knob counterclockwise  to "ON".
9. Replace control access panel.
10. Turn on all electric power to the appliance.
11. Set thermostat to desired setting.
12. If the appliance will not operate, follow the instructions "TO TURN OFF GAS TO APPLIANCE" and call your service technician or gas supplier.

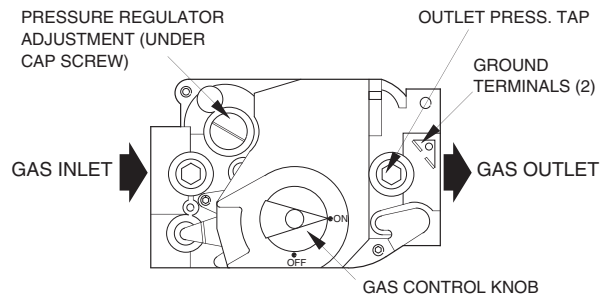

HONEYWELL VR8305M/P

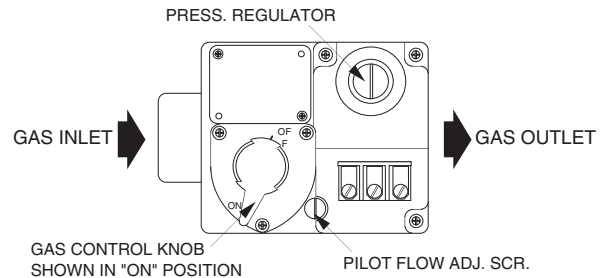

WHITE RODGERS 36C

TO TURN OFF GAS TO APPLIANCE

1. Set the thermostat to lowest setting.
2. Turn off all electric power to the appliance if service is to be performed.
3. Remove control access panel.
4. Turn the gas control knob clockwise  to "OFF". On W-R controls push the knob in before turning, don't force it.
5. Replace control access panel.

POUR VOTRE SÉCURITÉ LISEZ AVANT DE METTRE EN MARCHÉ

AVERTISSEMENT. Quiconque ne respecte pas à la lettre les instructions dans la présente notice risque de déclencher un incendie ou une explosion entraînant des dommages, des blessures ou la mort.

- A. 1. Cet appareil est muni d'une veilleuse qui doit être allumée manuellement. Respectez les instructions ci-dessous à la lettre.
2. Cet appareil ne comporte pas de veilleuse. Il est muni d'un dispositif d'allumage qui allume automatiquement le brûleur. Ne tentez pas d'allumer le brûleur manuellement.
- B. AVANT DE FAIRE FONCTIONNER, renifllez tout autour de l'appareil pour détecter une odeur de gaz. Renifllez près du plancher, car certains gaz sont plus lourds que l'air et peuvent s'accumuler au niveau du sol.
- QUE FAIRE SI VOUS SENTEZ UNE ODEUR DE GAZ
- Ne pas tenter d'allumer l'appareil.
 - Ne touchez à aucun interrupteur; ne pas vous servir des téléphones se trouvant dans le bâtiment.
- Appelez immédiatement votre fournisseur de gaz depuis un voisin. Suivez les instructions du fournisseur.
 - Si vous ne pouvez rejoindre le fournisseur, appelez le service des incendies.
- C. Ne poussez ou tournez la manette d'admission du gaz qu'à la main; ne jamais utiliser d'outil. Si la manette reste coincée; ne pas tenter de la réparer; appelez un technicien qualifié. Le fait de forcer la manette ou de la réparer peut déclencher une explosion ou un incendie.
- D. N'utilisez pas cet appareil s'il a été plongé dans l'eau, même partiellement. Faites inspecter l'appareil par un technicien qualifié et remplacez toute partie du système de contrôle et toute commande qui ont été plongés dans l'eau.

INSTRUCTIONS DE MISE EN MARCHÉ

1. ARRÊTEZ! Lisez les instructions de sécurité sur la portion supérieure de cette étiquette.
2. Mettez le thermostat à la température la plus basse.
3. Coupez l'alimentation électrique de l'appareil.
4. Cet appareil est équipé d'un dispositif d'allumage automatique du brûleur.
5. Enlever le panneau de protection du réchauffeur.
6. Tourner le bouton de commande de gaz vers la droite, en position d'arrêt "OFF". Ne pas forcer!
7. Attendre cinq (5) minutes pour laisser échapper tout le gaz. Renifllez tout autour de l'appareil, y compris près du plancher, pour détecter une odeur de gaz. Si vous sentez une odeur de gaz, ARRÊTEZ! Passez à l'étape B des instructions de sécurité sur la portion supérieure de cette étiquette. S'il n'y a pas d'odeur de gaz, passez à l'étape suivante.
8. Tourner le bouton de commande de gaz vers la gauche, en position de marche "ON".
9. Replacer le panneau de protection du réchauffeur.
10. Rétablir toute l'alimentation électrique de la chaudière.
11. Mettez le thermostat sur le réglage désiré.
12. Si l'appareil ne fonctionne pas, voir les instructions de "COÛTURE DE L'ARRIVÉE DE GAZ À LA CHAUDIÈRE" et appeler un technicien réparateur ou le fournisseur de gaz.

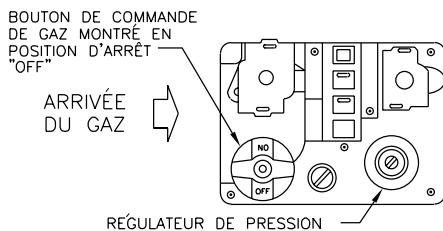

COÛTURE DE L'ARRIVÉE DE GAZ À LA CHAUDIÈRE

1. Mettez le thermostat à la température la plus basse.
2. Si un entretien doit être effectué, coupez l'alimentation électrique de l'appareil.
3. Lever le panneau de protection du réchauffeur.
4. Tourner le bouton de commande de gaz vers la droite, en position d'arrêt "OFF". Ne pas forcer!
5. Replacer le panneau de protection du réchauffeur.

**GB100W NATURAL OR PROPANE BOILER
INSTALLATION AND OPERATING INSTRUCTIONS**

BOILER OPERATION

WARNING: Before attempting to operate this boiler you !MUST! read and fully understand the lighting instructions in the “For Your Safety Read Before Operating” section of this manual. If you attempt to operate this boiler without a full understanding of it’s ignition system a fire or explosion may result causing extensive property damage, severe personal injury or death!

WARNING: Before proceeding read and fully understand the instructions contained in this manual. Do not attempt to operate this boiler if it has not been installed in accordance with the guidelines set forth in this manual.

Should overheating occur or the gas supply fail to shut off, do not turn off or disconnect the electrical supply to the pump. Instead, shut off the gas supply at a location external to the appliance.

En cas de surchauffe ou si l'alimentation de gaz ne peut être coupée, ne pas couper ni débrancher l'alimentation électrique de la pompe. Fermer plutôt le robinet d'admission de gaz à l'extérieur de l'appareil..

Do not use this appliance if any part has been under water. Immediately call a qualified service technician to inspect the appliance and to replace any part of the control system and any gas control that has been under water.

N'utilisez pas cet appareil s'il a été plongé dans l'eau, même partiellement. Faites inspecter l'appareil par un technicien qualifié et remplacez toute partie du système de contrôle et toute commande qui ont été plongés dans l'eau.

Continuous Pilot System

A. Connect a manometer having a minimum capacity of 10" WC to the outlet pressure port of the gas valve. Make sure that the gas supply piping has been purged of air and that all gas joints up to the gas valve have been thoroughly checked for leaks. Wait at least five minutes for the gas to dissipate before turning on the electrical power.

B. Read, understand and follow the lighting instructions contained in this manual that are applicable to the type of ignition system installed on the boiler.

CAUTION: To prevent being burned, take care not to touch any hot metal parts. Stand clear of the boiler during ignition to prevent being burned in the case of flashback.

C. Raise the thermostat at least 5 degrees above the room temperature. The burners should light.

D. A boiler designed for use with natural gas should have a manifold gas pressure of 3.5" WC. On an LP boiler, the manifold pressure should be 10" WC. To adjust the manifold gas pressure, remove the gas valve pressure regulator cap and turn the regulator screw to obtain the correct pressure.

E. Test the ignition safety shutoff device, turn the gas control knob on the gas valve to “PILOT”. The burners should go out. Extinguish the pilot and wait 3 minutes. Turn the gas valve control knob to “ON”. There should be NO gas flow to the main burners with the pilot out! If gas flow is detected, immediately turn the gas valve control knob to “OFF” and have the problem corrected.

Intermittent & Direct Ignition Systems

A. Connect a manometer having a minimum capacity of 10 in, 254 mm, WC to the outlet pressure port of the gas valve. Make sure that the gas supply piping has been purged of air and that all gas joints up to the gas valve have been thoroughly checked for leaks. Wait at least five minutes for the gas to dissipate before turning on the electrical power.

B. Read, understand and follow the lighting instructions contained in this manual that are applicable to the type of ignition system installed on the boiler.

C. Raise the thermostat at least 5 degrees above the room temperature. For models equipped with an intermittent pilot the pilot should light and then the burners. If a direct ignition system is employed, a delay of approximately 20 seconds will take place as the silicon carbide ignitor heats up. Once the ignitor is hot, the main gas valve will open and the burners should light. If the burners fail to light the system will make two more ignition attempts. If the burners light, but go out within 4 seconds, the system will make three more ignition attempts. If the burners have not lit after the last ignition try, the gas valve will close and the system will go into lock out. DO NOT attempt to reset the system until the ignition system has been inspected and the problem resolved. After 5 minutes has passed since the last ignition attempt, reset the system by turning the thermostat to it's lowest setting and then back to where it was. Momentarily interrupting the electrical power to the boiler will also reset the system.

D. With the burners in operation, close the manual shutoff valve in the gas supply line. As soon as the burner flames go out, open the manual shutoff valve. A normal ignition sequence should take place.

E. With the burners in operation, interrupt the power to the control circuit by lowering and raising the thermostat. A normal ignition sequence should follow.

F. To test the ignition safety shutoff device, close the manual shutoff valve in the gas supply line. Within 6 seconds of main burner flame extinction, the main gas valve solenoid should close with an audible noise.

On intermittent pilot systems a ticking noise should be heard while the ignition module tries to relight the pilot. After 1 minute the module should lockout and the try for ignition end.

If a direct ignition system is employed, the ignitor should glow and an attempt at ignition take place. After unsuccessfully attempting to light the main burners the ignition module should lock out.

Open the manual shutoff valve in the gas supply line. Reset the ignition control system by interrupting, then restoring electrical power to the boiler. A normal ignition sequence should take place.

BOILER CHECKING & ADJUSTMENT

Pilot Adjustment

The pilot burner flame should envelope **3/8 in, 9.5 mm** to **1/2 in, 13 mm**, of the thermocouple tip or flame sensing probe, depending on the pilot type. If the pilot flame is out of adjustment, remove the cap next to the pilot tube fitting on the gas valve. Turn the pilot adjustment screw clockwise to decrease the flame, counterclockwise to increase it. Figure 18 depicts a constant pilot, but the adjustment dimensions for an intermittent pilot would be the same.

Figure 18: Pilot Location

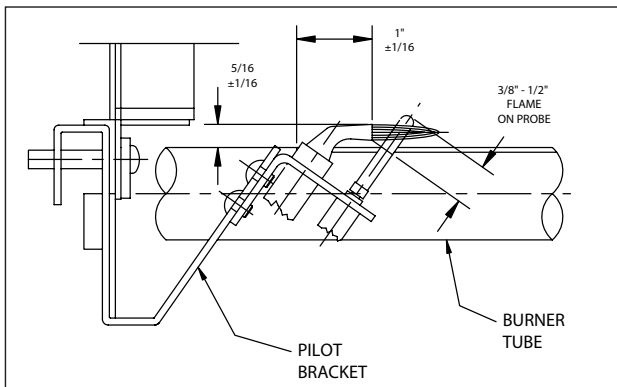

Gas Pressure Adjustment

NATURAL GAS: Optimum results are obtained when the boiler is operated at its full input rating, with **3.5 in, 89 mm**, WC of manifold pressure. The manifold pressure should not be more that 5% off this value. The gas valve pressure regulator has been preset at the factory. If adjustment is necessary the following steps must be followed:

1. Attach a manometer to the pressure tap on the gas valve body.
2. Remove the regulator adjustment screw cap from the gas valve body.
3. Rotate the regulator adjustment screw clockwise to increase the manifold pressure, counterclockwise to decrease it.
4. Replace the regulator adjustment screw cap and pressure tap plug.

CAUTION: Never force the regulator adjustment screw beyond the stop limits or damage to the gas valve will occur!

PROPANE GAS: A manifold pressure of **10.0 in, 254 mm**, WC must be maintained for proper operation of the boiler. If the manifold pressure is off by more than 5% adjust it according to steps 1 through 4 above.

Input Rate

Gas appliances are rated based on sea level operation with no adjustment required at elevations up to 2000 feet. At elevations above **2000 ft, 610 m**, input ratings should be reduced by 4% for each **1000 ft, 305 m** above sea level. Check the input rate as follows:

1. Turn off all other gas appliances that use the same gas meter as the boiler.
2. Call your gas supplier and ask for the heating value of the gas.
3. Start the boiler and let it run for 15 minutes.
4. Using the gas meter and a stop watch, clock the time that it takes to burn 1 cubic foot of gas. To increase the accuracy of the time, clock the time that it takes to burn 10 cubic feet of gas and divide the time by 10.
5. Insert the heating value and the time, in seconds, into the formula below.

$$\text{RATE in} = \frac{\text{HEATING VALUE (BTU/FT}^3\text{) (3600S/HR)}}{\text{Time (s/ft}^3\text{)}}$$

EXAMPLE: If: heating value = 1000 BTU/ft³
time/ft³ = 18 s/ft³

$$\text{RATE in} = \frac{(1000 \text{ BTU/ft}^3) (3600 \text{ s/hr})}{18 \text{ s/ft}^3}$$

$$\text{RATE in} = 200,000 \text{ BTU/hr}$$

GB100W NATURAL OR PROPANE BOILER INSTALLATION AND OPERATING INSTRUCTIONS

If the computed rate deviates by more than 5% from the rated input value of the unit adjust the gas valve pressure accordingly. DO NOT adjust the manifold pressure by more than 5%. If a proper rate cannot be maintained without adjusting the manifold pressure beyond the 5% limit, the main burner orifices must be replaced. If the input rate is too low, go to the next larger size orifices. If the input rate is too high, go to the next smaller size.

CAUTION: Never increase the input to the boiler above that for which it is rated. Doing so can cause premature failure of the boiler!

WARNING: Yellow, floating flames indicate a lack of combustion air. Do not operate the boiler until the problem is solved or severe personal injury or death may occur!

Low Water Cutoff

If the boiler is equipped with a low water cutoff device make sure that the main burners will NOT light when the boiler has no water in it. To check, turn the boiler off, close the valves in the water supply and return lines and drain the boiler. If the boiler's main burners light shut the boiler off immediately and correct the problem.

Thermostat Adjustment

For a thermostat that employs an adjustable heat anticipator, adjust the anticipator to match the current measured in the thermostat circuit. An increased anticipator setting may be necessary if the unit cycles frequently. If the room temperature over-shoots the thermostat setting, reduce the anticipator setting.

BOILER MAINTENANCE

WARNING: The ceramic combustion chamber in the burner box and its gasket contain crystalline silica. Wear a tightly fitted dust mask when servicing the burner and gently handle the burner and its gasket to prevent inhalation of airborne fibers. Crystalline silica fibers have been identified as carcinogenic, or possibly carcinogenic when inhaled.

CAUTION: Servicing, inspection and adjustment must be done by a trained technician in accordance with all applicable local and national codes. Verify proper operation after servicing. Improper servicing or adjustment can damage the boiler!

The boiler should be cleaned and inspected once a year, before each heating season. Make sure that the burners and ignition components are free from dust, soot, dirt, corrosion or other deposits that would impair the boiler's performance. Refer to Replacement Parts page for component identification.

Burner Removal

1. Close the manual shutoff valve in the gas supply line and turn off electrical power to the boiler.
2. Disconnect the boiler ground joint union, see Figure 12.
3. Remove the front access panel.
4. Where applicable, disconnect the wires, pilot tube and thermocouple from the gas valve.
5. Remove the two nuts that retain the manifold assembly and remove the assembly.
6. The burner support panel has two jacket screws in it. Remove the screws to free the support panel and burners.

Burner Installation

1. DO NOT install damaged or badly corroded burners - replace them.
2. Insert the crimped end of each burner into the burner base rear panel slots. Carefully slide the burner support panel over the burner tubes and studs.
3. Work the manifold assembly into position and reattach it using the two nuts.
4. Replace the two jacket screws and reconnect all wires, tubing and anything else that was disconnected during the burner removal operation.
5. Complete the reassembly and follow the instructions in the BOILER OPERATION section of this manual.

Heat Exchanger Cleaning

The burners should be removed to protect them from falling rust and scale. Follow the Burner Removal instructions in this manual.

1. Disconnect the vent pipe and the stack damper.
2. Remove the front access and top panels.
3. Disconnect the spill switch wires.
4. Remove the two screws from the flue collector retaining clips. Separate the flue collector from the heat exchanger.
5. Remove the flue collector.
6. Remove as much of the old flue collector sealant as possible. Thoroughly clean the flue passages with a wire brush.
7. Vacuum out the burner base and clean and inspect all of the components. Replace any damaged or badly corroded parts.
8. Reseal the flue collector using Dow Corning #732 or an equivalent sealant. And install the flue collector retaining clips and screws.

WARNING: Failure to properly seal the flue collector to the heat exchanger can result in leakage of combustion products which can result in severe personal injury or death!

9. Replace the top panel and reconnect the spill switch wires and vent system.
10. Follow the Burner Installation procedure outline in this section.

Vent System

Thoroughly inspect the vent system for any signs of blockage, corrosion or leakage. Immediately replace any unsound vent system piping.

WARNING: Failure to properly inspect the vent system on a regular basis may leave problems undetected that can result in excessive levels of carbon monoxide which can cause severe personal injury or death!

Controls

Use the BOILER OPERATION and BOILER CHECKING AND ADJUSTMENT sections of this manual as a reference.

1. Check the thermostat for proper operation.
2. If the boiler has been equipped with a low water cutoff device, L.W.C.O, ensure that it operates properly. A float type L.W.C.O. should be flushed out.
3. The relief valve should vent water when the test lever is lifted. It should not weep or discharge water at normal system pressure. NEVER try to clean or repair the relief valve! If the valve fails to operate properly, replace it!
4. The aquastat high limit controls the maximum water temperature in the boiler. It is adjustable from **140°F, 60°C** to **240°F, 116°C**. If the water temperature reaches the set temperature before the demand for heat has been met, the aquastat high limit should shut the boiler off. The water temperature should never exceed the maximum set point of **240°F, 60°C**. The aquastat high limit cannot be repaired. If it fails to function properly replace it.

INSTRUCTIONS TO THE INSTALLER

This copy of the INSTALLATION AND OPERATING INSTRUCTIONS should be given to the owner of this boiler and kept on file.

The INSTALLER must make sure that the owner or operator has a basic understanding of the following:

1. The lighting instructions, the type of ignition system installed and how it operates.
2. What the labels on the boiler say.
3. How to start up and shut off the boiler.
4. How to turn the gas and electrical power on or off.
5. What to do if the boiler shuts down on ignition system lock out.
6. Where to check the system temperature and pressure and what they should be.
7. The importance of reading, understanding and following these instructions.

The INSTALLER MUST make sure that the owner knows to shut the boiler off and call for service if the following conditions occur:

1. Yellow lazy flames or flames outside the boiler acket.
2. Gas smell or other strange odors.
3. Discoloration of boiler or surrounding materials due to overheating.
4. Water leaking from the heating system piping or relief valve.
5. Flue products leaking from the vent system into the living space. Dampness or condensation in the building is a good indicator of this condition.
6. The boiler's blocked vent shutoff system is actuated.
7. The boiler's flame roll-out safety system is actuated.
8. Control malfunction or sporadic operation.

**GB100W NATURAL OR PROPANE BOILER
INSTALLATION AND OPERATING INSTRUCTIONS**

REPLACEMENT PARTS

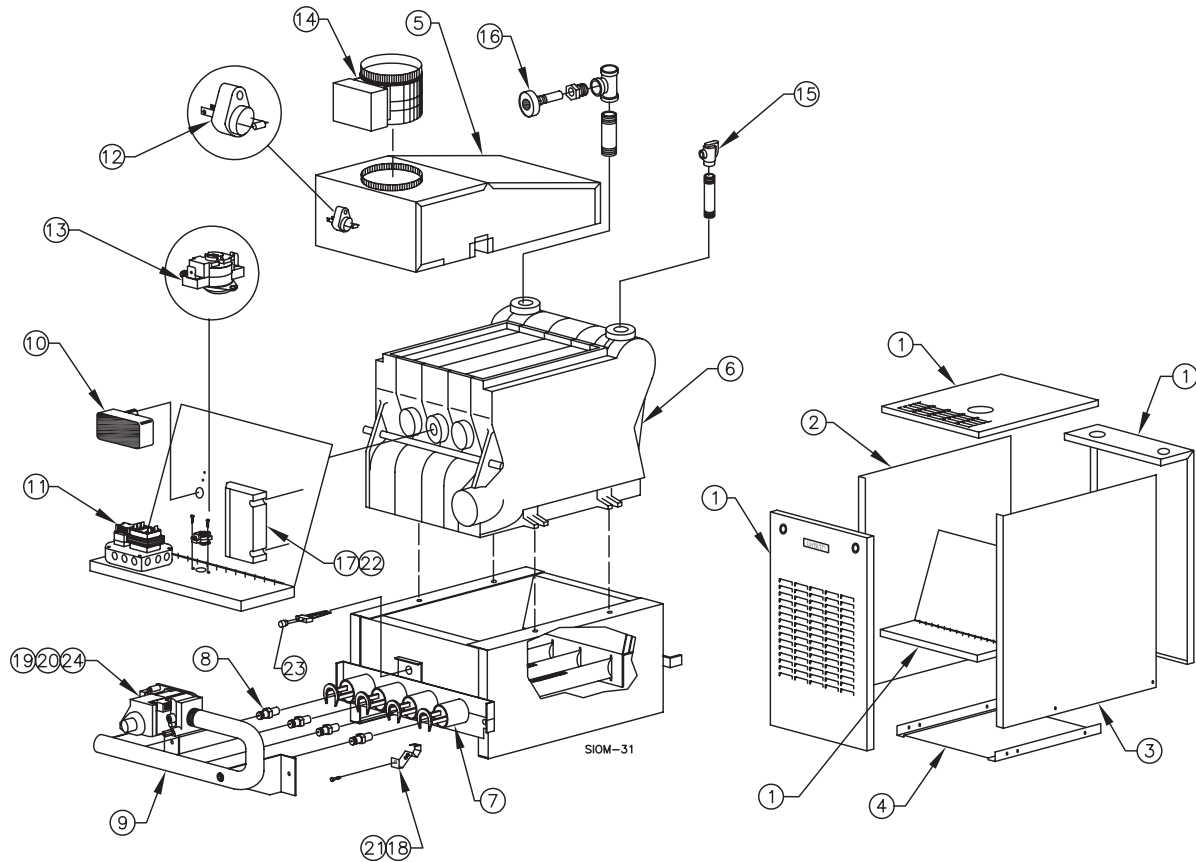

GB100 SERIES REPAIR PARTS

Ref #	Name of Part	Part No.	Number of Sections													
			3	4	5	6	7	8	9	10	11	12				
1	Top, Rear, Inner Front and Front Panels	55703	1													
		55704		1												
		55705			1											
		55706				1										
		55707					1									
		55708						1								
		55709							1							
		55710								1						
		55711									1					
		55712										1				
																1
		2	Left Side Panel	55701	1	1	1	1	1	1	1	1	1	1	1	1
3	Right Side Panel	55702	1	1	1	1	1	1	1	1	1	1	1	1		
4	Floor Pan	55813	1													
		55814		1												
		55815			1											
		55816				1										
		55817					1									
		55818						1								
		55819							1							
		55820								1						
		55821									1					
		55822										1				

**GB100W NATURAL OR PROPANE BOILER
INSTALLATION AND OPERATING INSTRUCTIONS**

CANADIAN SUPPLEMENT

DANGER

Only the boiler may be served by the vent damper. Do not use it to vent an additional appliance; this will cause a fire or carbon monoxide poisoning.

DANGER

LE VOLET DE VENTILATION DOIT SERVIR SEULE-MENT À LA CHAUDIÈRE. NE PAS L'UTILISER POUR VENTILER D'AUTRES APPAREILS; SINON CELA POURRAIT PROVOQUER UN INCENDIE OU CAUSER UN EMPOISONNEMENT PAR LE MONOXYDE DE CARBONE.

METHOD OF INSTALLATION FOR MOTORIZED VENT DAMPER

MÉTHODE D'INSTALLATION POUR LE VOLET MOTORISÉ DE VENTILATION

The damper must be mounted as close as possible to the draft hood without modifying the draft hood or damper device.

Attach the lower portion of the vent damper to the draft hood with **1/2 in, 13 mm** or shorter screws or pop rivets.

Do not install within **6 in, 152 mm**, of combustible materials. Make sure the motor actuator and position indicator are readily visible and accessible.

Plug the Molex connector on the damper harness into the mating plug on the harness located inside the control compartment.

Determine the amperage draw of the gas control circuit and damper device. Check heat anticipator in comfort thermostat to determine that it's properly adjusted.

To manually open the damper, follow instructions inside the damper cover.

Le registre doit être installé aussi près que possible du coupe-tirage sans qu'une modification de ce coupe-tirage ou le registre ne soit nécessaire.

Attacher la partie inférieure du volet de ventilation au coupe-tirage à l'aide de vis de 13 mm ou plus courtes ou des rivets aveugles.

Ne pas installer le registre à moins de 152mm des matériaux de combustion. S'assurer que dispositif de commande du moteur est visible et facilement accessible.

Enficher la prise Molex sur le faisceau de fils du volet de ventilation dans la prise à l'intérieur d'armoire de commande.

Déterminer l'appel de courant en ampères du circuit du régulateur de gaz et du registre. Vérifier la résistance anticipatrice de chaleur du thermostat d'ambiance afin de déterminer si elle est correctement réglée.

Pour ouvrir manuellement le registre suivre les instructions apparaissant à l'intérieur du couvercle.

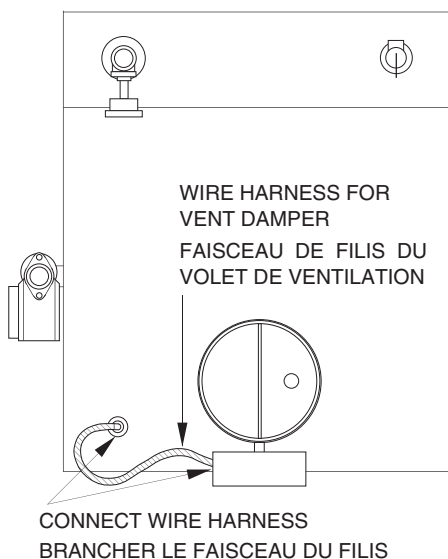

DAMPER MUST BE IN OPEN POSITION WHEN APPLIANCE MAIN BURNERS ARE OPERATING.

LE REGISTRE DOIT ÊTRE EN POSITION OUVERTE LORSQUE LE BRULEUR PRINCIPAL EST EN MARCHE.

POSITION INDICATOR
DISPOSITIF DE COMMANDE

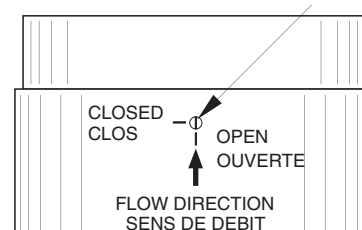

LIMITED LIFETIME WARRANTY FOR RESIDENTIAL WATER BOILERS

This warranty statement is effective for all units manufactured after December 15, 1992 and supersedes all other warranties, including those contained in other documents which might be included with this merchandise. This warranty applies only to the original homeowner at the original place of installation.

First Through Tenth Year

Westcast, Inc. warrants that the cast iron sections of its residential water boiler for Smith Cast Iron Boilers were free of defects in material and workmanship when shipped, and will remain free of defects under normal usage from the date of original installation, for a period of ten years. In the event that the cast iron section is found to be defective in material or workmanship during this period, Westcast, Inc. will repair or replace, at its option, the defective section.

Eleventh Year and Above

Westcast, Inc. warrants that the cast iron sections of its residential water boilers will remain free of defects in material and workmanship under normal usage for the lifetime of the original owner at the original place of installation. Should any sections be found to be defective, Westcast, Inc. will repair or replace, at its option, the original cast iron sections upon the payment of a proportionate charge based on the time the defective section was in service. The proportionate charge will be equal to the appropriate percentage of the retail price of the section at the time the warranty claim is made, determined as follows:

Year	11th	12th	13th	14th	15th	16th	17th	18th	19th	20th	21st	23nd	24th	25th & above
% of Retail Price	5	10	15	20	25	30	35	40	45	50	55	60	65	75

Procedure for Obtaining Warranty Service

The homeowner should perform the following in order to insure prompt warranty service:

1. Notify the installer, who in turn should notify the distributor, promptly upon discovery of a condition believed to be caused by a defect in manufacture. Failing this, the owner should notify Westcast, Inc., 260 North Elm St., Westfield, MA 01085 in writing, giving full particulars in support of the claim.
2. Make available for inspection to Westcast, Inc. or its representative the parts alleged to be defective, and if requested by Westcast, Inc., ship said parts prepaid to Westcast, Inc., 47 Westfield Industrial Park Road, Westfield, MA 01085 for inspection or repair.
3. The homeowner is required to complete and mail the Warranty card attached hereto within ten days after the installation of the boiler before coverage under the Warranty commences.

Exceptions and Exclusions

1. This Warranty covers cast iron boiler sections only. Other cast iron parts such as but not limited to grates and grate parts are specifically not warranted. The burner, jacket, controls and other auxiliary equipment furnished by Westcast, Inc., but purchased from others shall be limited to that manufacturer's warranty, if any.
2. This Warranty does not include expenses for removal or re-installation. The user will be responsible for the cost of replacement of the defective part and labor and material necessary to the exchange. Replacement material will be invoiced to the Distributor in the usual manner and will be subject to adjustment upon proof of defect.
3. Nothing herein shall be construed as a guaranty of workmanship of any installer in installing Westcast, Inc. cast iron boilers, or as imposing on the Company any liability of any nature for unsatisfactory performance caused by faulty workmanship in installation, which liability is expressly disclaimed.
4. This Warranty will not apply if the boiler is structurally altered; is used or operated at over its rated capacity; or is not maintained in accordance with Westcast, Inc.'s recommendations or the accepted good practice of the industry as defined by the Hydronics Institute, A.S.M.E. or other accepted authority.
5. This Warranty will not apply if the boiler has been damaged a result of: fire or other casualties; flooding or exposure to the elements; settlement, distortion, collapse or cracking of any foundation area, beams or pipes surrounding the boiler; improper or negligent installation, service or operation (including but not limited to the following - operated with insufficient water, allowed to freeze; subject to flood conditions; or operated with water conditions and/or fuels or additives which have caused unusual deposits or corrosion in or on the cast sections).
6. This Warranty applies only to boilers installed within the United States and Canada.
7. In order for this Warranty to be effective:
 - A. The boiler must have been properly installed in a single or two-family residential dwelling. Warranty does not apply to boilers installed in apartments, commercial or industrial installations.
 - B. The boiler must have been assembled in strict accordance with Westcast, Inc. installation instructions furnished with the boiler.
 - C. Boiler sections must not have been damaged in handling during shipment or installation. The determination of damage in handling or installation is a considered judgement of Westcast, Inc. and decision shall be final.
 - D. The boiler must have been serviced annually by a licensed contractor and proof of such service must be provided with warranty claim. This service must include but is not limited to fireside cleaning and proper burner adjustment with combustion testing.
8. In no case shall Westcast, Inc.'s liability exceed the original selling price of the product found to be defective.
9. THIS WARRANTY IS IN LIEU OF ALL EXPRESS WARRANTIES OF ANY KIND. THE REMEDIES UNDER THIS WARRANTY ARE EXCLUSIVE AND WESTCAST, INC. NEITHER ASSUMES NOR AUTHORIZES ANYONE TO ASSUME FOR IT ANY OTHER OBLIGATIONS. IN NO EVENT SHALL WESTCAST, INC. BE LIABLE UNDER THIS WARRANTY OR OTHERWISE IN ANY MANNER FOR ANY INCIDENTAL, REMOTE OR CONSEQUENTIAL DAMAGES RESULTING FROM BREACH OF THIS WARRANTY OR CONDITION IMPLIED BY LAW OR OTHERWISE, INCLUDING ANY IMPLIED WARRANTY OF MERCHANTABILITY OR FITNESS, FOR A PARTICULAR PURPOSE. SOME STATES DO NOT ALLOW THE EXCLUSION OR LIMITATION OF INCIDENTAL OR CONSEQUENTIAL DAMAGES, SO THE ABOVE LIMITATION OR EXCLUSION MAY NOT APPLY TO YOU.
10. This Warranty gives you specific legal rights, and you may also have other rights which vary from state to state.

WARNING

Any appliance that burns natural gas, propane gas, fuel oil, wood or coal is capable of producing carbon monoxide (CO).

Carbon Monoxide (CO) is a gas which is odorless, colorless and tasteless but is very toxic.

If your Smith boiler is not working properly, or is not vented properly, dangerous levels of CO may accumulate. CO is lighter than air and thus may travel throughout the building. **BRIEF EXPOSURE TO HIGH CONCENTRATIONS OF CO, OR PROLONGED EXPOSURE TO LESSER AMOUNTS OF CO MAY RESULT IN CARBON MONOXIDE POISONING.**

EXPOSURE CAN BE FATAL AND EXPOSURE TO HIGH CONCENTRATIONS MAY RESULT IN THE SUDDEN ONSET OF SYMPTOMS INCLUDING UNCONSCIOUSNESS.

Symptoms of CO poisoning include the following:

dizziness	vision problems	shortness of breath
headaches	loss of muscle control	unclear thinking
nausea	weakness	unconsciousness

The symptoms of CO poisoning are often confused with those of influenza, and the highest incidence of poisoning occurs at the onset of cold weather or during flu season. A victim may not experience any symptoms, only one symptom, or a few symptoms. Suspect the presence of carbon monoxide if symptoms tend to disappear when you leave your home.

The following signs may indicate the presence of carbon monoxide:

- Hot gases from appliance, venting system, pipes or chimney, escaping into the living space.
- Flames coming out around the appliance.
- Yellow colored flames in the appliance.
- Stale or smelly air.
- The presence of soot or carbon in or around the appliance.
- Very high unexplained humidity inside the building.

If any of the symptoms of CO poisoning occur, or if any of the signs of carbon monoxide are present, **VACATE THE PREMISES IMMEDIATELY AND CONTACT A QUALIFIED HEATING SERVICE COMPANY OR THE GAS COMPANY OR THE FIRE DEPARTMENT.**

To reduce the risk of CO poisoning, have your heating system "tuned up" by a licensed heating contractor or the gas company -- preferably before each heating season. Also have the service company check your chimney or vent pipes for blockage.

Your home should also be adequately ventilated, particularly if you have insulated your home.

**ONLY QUALIFIED, LICENSED SERVICE CONTRACTORS
SHOULD PERFORM WORK ON YOUR SMITH BOILER.**

WARNING

Install, operate and maintain unit in accordance with manufacturer's instructions to avoid exposure to fuel substances or substances from incomplete combustion which can cause death or serious illness. The State of California has determined that these substances may cause cancer, birth defects, or other reproductive harm. Also, install and service this product to avoid exposure to airborne particles of glasswool fibers and/or ceramic fibers known to the State of California to cause cancer through inhalation.

Smith
CAST IRON BOILERS

WESTCAST, INC.
260 NORTH ELM STREET WESTFIELD, MA 01085
TEL. (413) 562-9631 FAX (413) 562-3799