

tekmar® - Data Brochure

Boiler Control 263

D 263

03/09

The tekmar Boiler Control 263 can control the supply water temperature from a single modulating boiler or up to 2 on / off stages based on outdoor temperature, domestic hot water requirements, or setpoint requirements. A large easy to read display provides current system temperatures and operating status. The control has an internal setback timer, which can have 2 events per day on a 24 hour, 5-1-1 day or 7 day schedule.

Additional functions include:

- Outdoor Reset
- Installer and Advanced access levels
- Primary pump output
- Pump exercising
- Pump purging
- Boiler demand for space heating loads
- DHW demand for domestic hot water loads
- Setpoint demand for setpoint loads
- Optional indoor sensor for room air temperature control
- Test sequence to ensure proper component operation
- Internal setback timer for energy savings
- Setback input for energy savings
- CSA C US certified

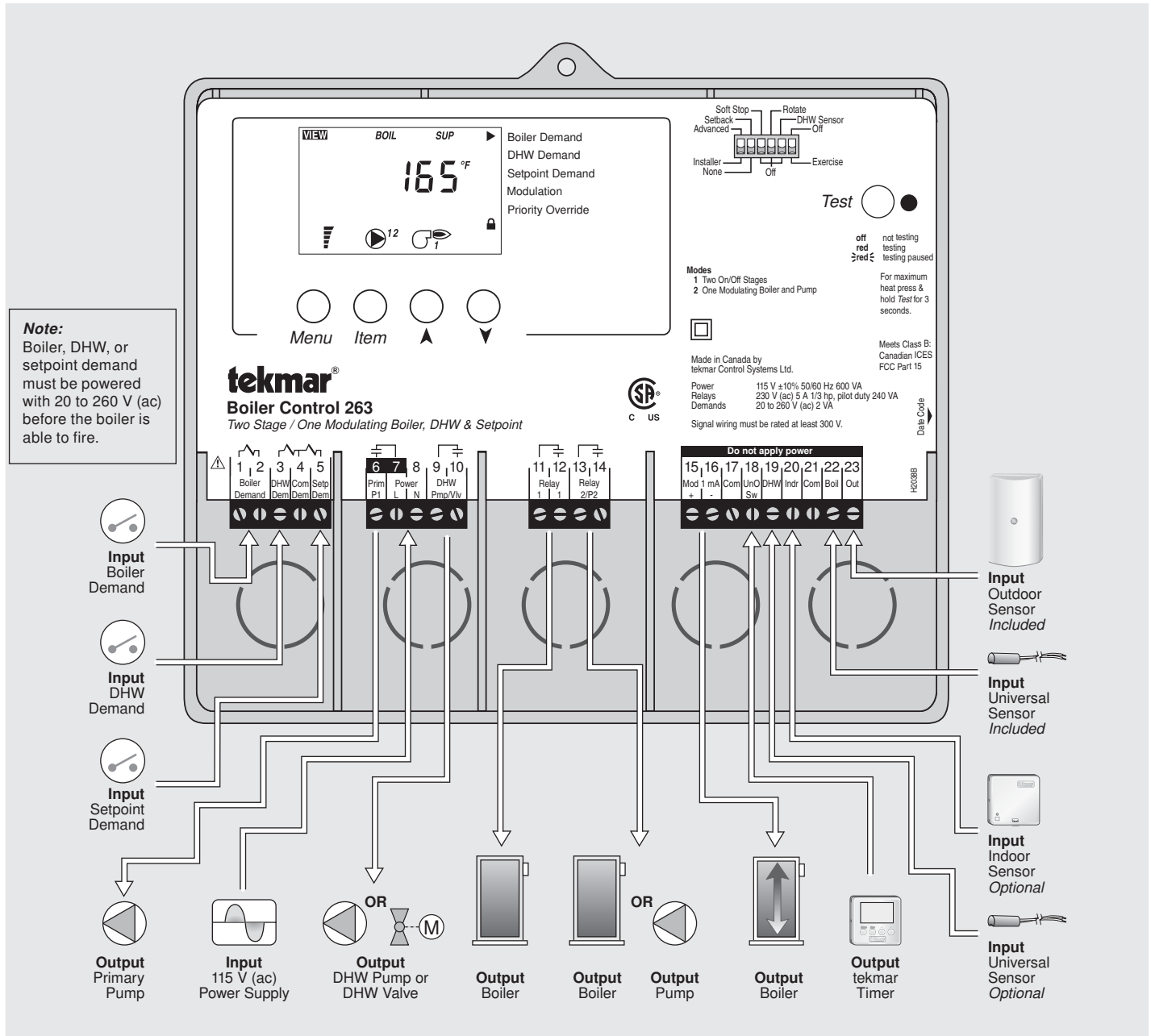

How To Use The Data Brochure

This brochure is organized into four main sections. They are: 1) Sequence of Operation, 2) Installation, 3) Control Settings, and 4) Testing and Troubleshooting. The Sequence of Operation section has six sub-sections. We recommend reading Section A: General of the Sequence of Operation, as this contains important information on the overall operation of the control. Then read the sub sections that apply to your installation.

The Control Settings section (starting at DIP Switch Settings) of this brochure describes the various items that are adjusted and displayed by the control. The control functions of each adjustable item are described in the Sequence of Operation.

Table of Contents

User Interface.....Pg 2	DIP Switch Settings.....Pg 25
DisplayPg 3	Control Settings.....Pg 26
Sequence of OperationPg 4	View MenuPg 26
Section A: General OperationPg 4	Adjust MenuPg 27
Section B: Boiler Operation.....Pg 6	Time MenuPg 30
Section C: Pump Operation.....Pg 11	Schedule MenuPg 31
Section D: Boiler Reset OperationPg 12	Testing the ControlPg 32
Section E: DHW OperationPg 14	Error Messages.....Pg 33
Section F: Setpoint Operation.....Pg 17	Technical Data.....Pg 36
Installation.....Pg 18	Limited WarrantyPg 36

User Interface

The control uses a Liquid Crystal Display (LCD) as the method of supplying information. You use the LCD in order to setup and monitor the operation of your system. The control has four push buttons (*Menu*, *Item*, ▲, ▼) for selecting and adjusting settings. As you program your control, record your settings in the ADJUST menu table, which is found in the second half of this brochure.

Menu

All of the items displayed by the control are organized into four menus (*View*, *Adjust*, *Time*, *Schedule*). These menus are listed on the top left hand side of the display (Menu Field). To select a menu, use the **Menu** button. By pressing and releasing the **Menu** button, the display sequences between the four menus. Once a menu is selected, there will be a group of items that can be viewed within the menu.

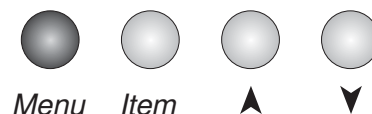

Item

The abbreviated name of the selected item will be displayed in the item field of the display. To view the next available item, press and release the **Item** button. Once you have reached the last available item in a menu, pressing and releasing the **Item** button will return the display to the first item in the selected menu.

The items can be quickly scrolled through by holding the **Item** button and then pressing the ▼ button. To rapidly scroll through the items in the reverse order, hold the **Item** button and press the ▲ button.

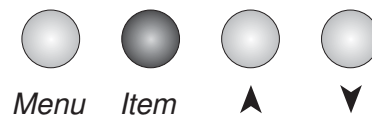

Adjust

To make an adjustment to a setting in the control, begin by selecting the ADJUST, TIME or SCHEDULE menu using the **Menu** button. Then select the desired item using the **Item** button. Finally, use the ▲, and / or ▼ button to make the adjustment.

Additional information can be gained by observing the Status field of the LCD. The status field will indicate which of the control's outputs are currently active. Most symbols in the status field are only visible when the VIEW menu is selected.

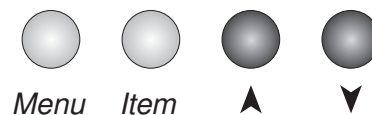

Display

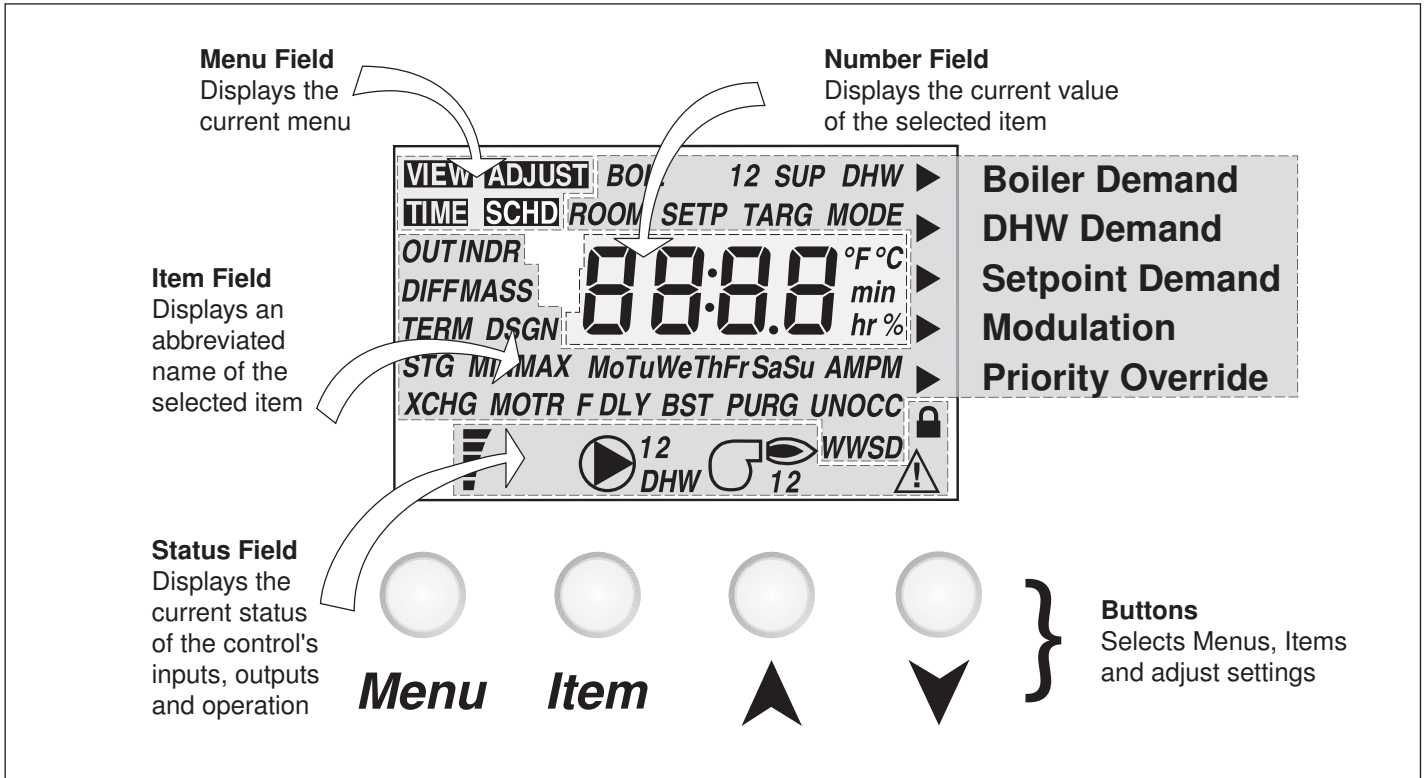

Symbol Description

	Burner Displays when Relay 1 and / or Relay 2 is turned on.		Warning Displays when an error exists or when a limit has been reached.
	Pump Displays when the primary or boiler pump is operating.		Lock / Unlock Displays when the Advanced / Installer DIP switch is set to Installer.
DHW	DHW Displays when the DHW pump is on.	°F °C min hr %	°F, °C, min, hr, % Units of measurement.
BST	Boost Displays when the control is in boost after setback.		Pointer Displays the control operation as indicated by the text.
OCC	Occupied Schedule Displays when the control is in occupied mode.	MoTuWeThFrSaSu AMPM	Day of Week Displays the day of the week and indicates morning or afternoon.
UNOCC	UnOccupied Schedule Displays when the control is in unoccupied mode.		Modulating Output Scale Displays the total modulation output level of the boiler.

Definitions

The following defined terms and symbols are used throughout this manual to bring attention to the presence of hazards of various risk levels, or to important information concerning the life of the product.



- Warning Symbol: Indicates presence of hazards which can cause severe personal injury, death or substantial property damage if ignored.



- Double insulated

**INSTALLATION
CATEGORY II**

- Local level, appliances

Sequence of Operation

Section A

General
Operation
Page 4 - 5

Section B

Boiler
Operation
Page 6 - 10

Section C

Pump
Operation
Page 11

Section D

Boiler Reset
Operation
Page 12 - 14

Section E

DHW
Operation
Page 15 - 17

Section F

Setpoint
Operation
Page 17 - 18

Section A: General Operation

POWERING UP THE CONTROL

When the control is powered up, all segments in the LCD are turned on for 2 seconds. Next, the control displays the control type number in the LCD for 2 seconds. Next, the software version is displayed for 2 seconds. Finally, the control enters into the normal operating mode.

OPERATING MODES

The control operates in two different operating modes:

Mode 1 – Two ON / OFF Stages

Mode 1 operates up to two on / off boilers or one boiler with two stages.

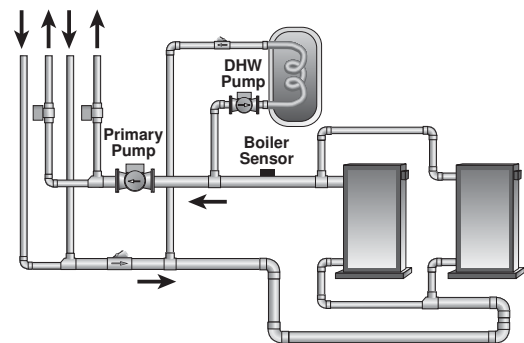

Mode 2 – One Modulating Boiler & Pump

Mode 2 operates one modulating boiler and the boiler pump.

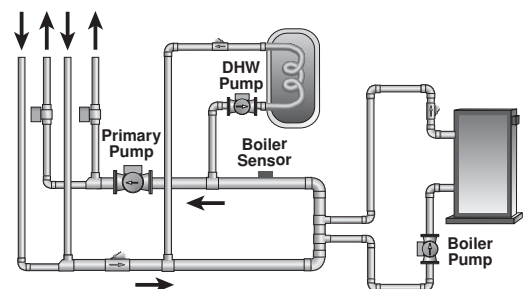

TYPES OF DEMANDS

The control stages or modulates the boiler(s) to control supply water temperature to a hydronic system. The supply water temperature is based on outdoor reset, a fixed temperature for DHW, or a fixed temperature for setpoint.

Boiler Reset

When a boiler demand signal from the heating system is present, the control operates the boiler(s) to maintain the supply temperature based on the outdoor air temperature and the Characterized Heating Curve settings. Refer to section D.

DHW

When a DHW demand is present, the control operates the boiler(s) to maintain the supply water temperature at least as hot as the DHW exchange setting or high enough to satisfy tank temperature. Refer to section E.

Setpoint

When a setpoint demand signal is present, the control operates the boiler(s) to maintain the supply water temperature at least as hot as the *Setpoint* setting. Refer to section F.

SETBACK (Occ and UnOcc)

To provide greater energy savings, the control has a setback feature. With setback, the supply water temperature in the system is reduced when the building is unoccupied. By reducing the supply water temperature, the air temperature in the space may be reduced even when thermostat(s) are not turned down.

The control has an internal setback timer with two events per day on either a 24 hour, a 5-1-1 day or a 7 day schedule.

The control also has an external setback input. Any time the *UnO Sw* (18) and the *Com* (17) are shorted together, the control operates in the unoccupied mode.

The external setback overrides the internal setback timer schedule to place the control into the unoccupied period.

When in the unoccupied mode, the *UNOCC* segment is displayed in the LCD. The control adjusts the supply water temperature based on the *UNOCC* settings made in the control.

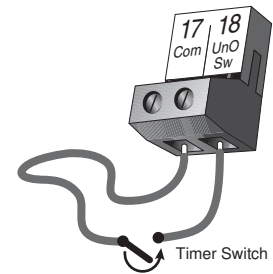

EXERCISING

The control has a built-in exercising feature that is selected through the *Exercise / Off DIP* switch. To enable the exercising feature set the *Exercise / Off DIP* switch to *Exercise*. If exercising is enabled, the control ensures that each pump is operated at least once every 3 days. If a pump has not been operated at least once every 3 days, the control turns on the output for 10 seconds. This minimizes the possibility of the pump seizing during a long period of inactivity. While the control is exercising, the *Test* LED flashes quickly.

Note: The exercising function does not work if power to the control or pumps is disconnected.

RUNNING TIMES

The control displays the accumulated running time of each boiler in the *VIEW* menu.

Resetting the Running Times

To reset the running time for each boiler, select the appropriate running time in the *VIEW* menu. Next press the ▲ and ▼ buttons simultaneously until *CLR* is displayed.

FACTORY DEFAULTS

The control comes preset with several factory defaults. These are based on the terminal unit selection. To fine-tune building requirements, these defaults may be changed.

To reload the factory default, power down the control and wait for 10 seconds. Power up the control while simultaneously holding the *Menu* and ▼ buttons. An E01 error occurs forcing the installer to go through the *ADJUST* menu to ensure the settings are correct.

Section B: Boiler Operation

Section B1
Boiler
Operation

Section B2
Mode 1
Two Stage
Operation

Section B3
Mode 2
Modulating
Boiler Operation

Section B1: Boiler Operation

BOILER TARGET TEMPERATURE

The boiler target temperature is determined by the type of demand received by the control. A boiler demand calculates a boiler target based on the characterized heating curve settings and the outdoor air temperature. A DHW demand and a Setpoint demand have temperature settings to which the boilers are operated to meet.

The control displays the temperature that it is currently trying to maintain as the boiler supply temperature. If the control does not presently have a requirement for heat, it does not show a boiler target temperature. Instead, “— —” is displayed in the LCD.

BOILER MINIMUM

The boiler minimum is the lowest temperature that the control is allowed to use as a boiler target temperature. During mild conditions, if the control calculates a boiler target temperature that is below the *Boiler Minimum* setting, the boiler target temperature is adjusted to at least the *Boiler Minimum* setting. During this condition, if the boiler(s) is operating, the minimum segment is turned on in the display when viewing either the boiler supply temperature or the boiler target temperature. Set the *Boiler Minimum* setting to the boiler manufacturer's recommended temperature.

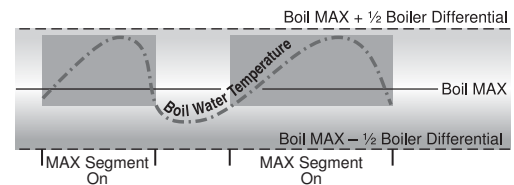
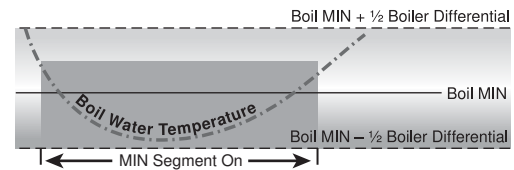

BOILER MAXIMUM

The boiler maximum is the highest temperature that the control is allowed to use as a boiler target temperature. If the control does target the *Boiler Maximum* setting, and the boiler temperature is near the boiler maximum temperature, the maximum segment will be displayed in the LCD while either the boiler target temperature or the boiler temperature is being viewed. At no time does the control operate the boiler(s) above 248°F (120°C).

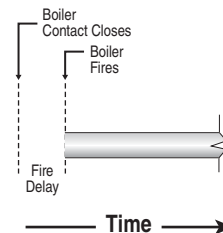

FIRE DELAY

The Fire Delay is the time delay that occurs between the time that the control closes a stage contact to fire a stage and the burner fires for that stage.

Section B2: Mode 1 - Two On / Off Stages Operation

STAGING

When operating in mode 1, the control operates up to two on / off stages in order to provide the required supply temperature. After a stage is turned on in the firing sequence, the control waits for a minimum time delay. The minimum time delay is adjustable using the *Stage Delay* setting. After the Stage Delay has expired, the control examines the control error to determine when the next stage is to fire. The control error is determined using Proportional, Integral and Derivative (PID) logic.

Proportional compares the actual supply temperature to the boiler target temperature. The colder the supply water temperature, the sooner the next stage is turned on.

Integral compares the actual supply temperature to the boiler target temperature over a period of time.

Derivative compares how fast or slow the supply water temperature is changing. If the supply temperature is increasing slowly, the next stage is turned on sooner. If the supply temperature is increasing quickly, the next stage is turned on later, if at all.

ROTATION

The control's Equal Run Time Rotation function is fixed at 48 hours. The firing order of the boilers changes whenever one boiler accumulates 48 hours more running time than the other boiler. After each rotation, the boiler with the least running hours is the first to fire and the boiler with the most running hours is the last to fire. This function ensures that both boilers receive equal amounts of use. When the *Rotate / Off* DIP switch is set to the *Off* position, the firing sequence always begins with boiler one and then boiler two.

Note: When using a single two-stage boiler, ensure that the *Rotate / Off* DIP switch is set to *Off*.

Resetting the Rotation Sequence

To reset the rotation sequence, set the *Rotate / Off* DIP switch to the *Off* setting for 5 seconds and then return the DIP switch to the *Rotate* setting.

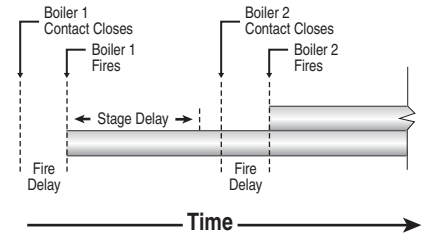
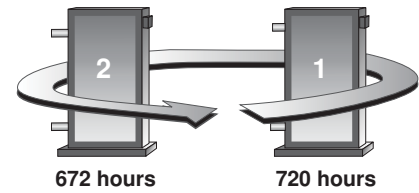
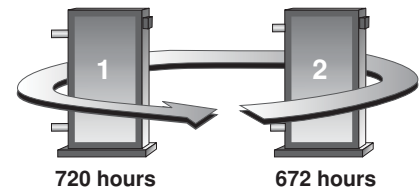

STAGE DELAY

The stage delay is the minimum time delay between the firing of stages. After this delay has expired the control can fire the next stage if it is required. This setting can be adjusted manually or set to an automatic setting. When the automatic setting is used, the control determines the best stage delay based on the operation of the system.

BOILER MASS

The *Boiler Mass* setting allows the installer to adjust the control to the thermal mass of the type of heat sources used in the application. If the heating system is causing the boiler(s) to be staged on and off in rapid succession, a higher *Boiler Mass* setting will result in a decrease in the amount of cycling. Conversely, if the system is slow to respond to heat requirements, then decreasing the *Boiler Mass* setting will increase the response rate by staging the boilers at a faster rate.

Lo (1)

The *Lo* setting is selected if the boiler(s) that is used has a low thermal mass. This means that the boiler(s) has a very small water content and has very little metal in the heat exchanger. A boiler that has a low thermal mass comes up to temperature quite rapidly when fired. This is typical of many copper fin-tube boilers. The *Lo Mass* setting provides a fast staging rate of additional on / off boiler stages.

Med (2)

The *Med* setting is selected if the boiler(s) that is used has a medium thermal mass. This means that the boiler(s) either has a large water content and a low metal content or a small water content and a high metal content. This is typical of many modern residential cast iron boilers or steel tube boilers. The *Med Mass* setting provides a moderate staging rate of additional on / off boiler stages.

Hi (3)

The *Hi* setting is selected if the boiler(s) that is used has a high thermal mass. This means that the boiler(s) has both a large water content and a large metal content. A boiler that has a high thermal mass is relatively slow in coming up to temperature. This is typical of many commercial cast iron and steel tube boilers. The *Hi Mass* setting provides a slow staging rate of additional on / off boiler stages.

DIFFERENTIAL

An on / off heat source must be operated with a differential in order to prevent short cycling. With the control, either a fixed or an auto differential may be selected. The boiler differential is divided around the boiler target temperature. The stage contact closes when the supply water temperature is $\frac{1}{2}$ of the differential setting below the boiler target temperature. Additional staging occurs if the first stage is unable to raise the supply water temperature up to the boiler target temperature at a reasonable rate. As the supply temperature reaches $\frac{1}{2}$ of the differential above the boiler target temperature, stages are staged off.

Fixed Differential

If the user desires to have a fixed differential, this is set using the *Boiler Differential* setting in the ADJUST menu.

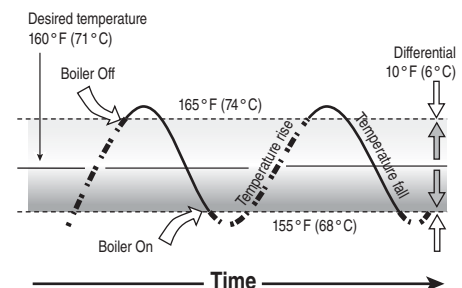

Auto Differential

If the Auto Differential is selected, the control automatically determines the best differential as the load changes. This reduces potential short cycling during light load conditions.

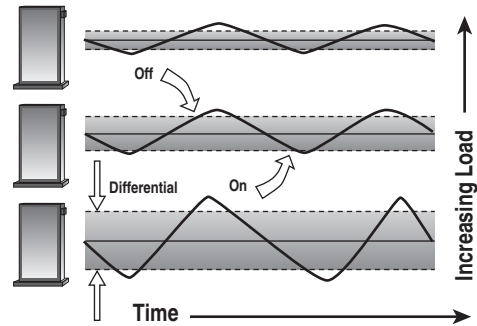

Section B3: Mode 2 - One Modulating Boiler and Pump Operation

MODULATION

When operating in Mode 2, the control provides a modulating output signal to operate a single modulating boiler. The control first closes the boiler contact on to ignite the ignition sequence. The boiler is then modulated from the minimum modulation using Proportional, Integral and Derivative (PID) logic in order to satisfy the boiler target temperature.

MOTOR SPEED

The *Motor Speed* is the amount of time the boiler requires to go from 0% modulation to 100% modulation.

Gas valve actuating motors have a design time from fully closed to fully open which can be found in the manufacturer's manual. The *Motor Speed* should be set to this time.

The *Motor Speed* setting for a Variable Frequency Drive (VFD) is the amount of time required to go from a stopped position to 100% fan speed. Since a VFD has a very quick response rate, it may be necessary to increase the *Motor Speed* setting in order to increase the stability of the boiler modulation.

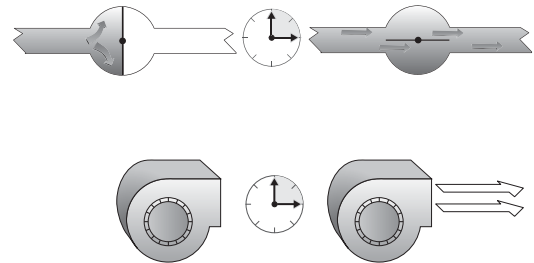

MODULATION RANGE (4 to 20 mA or 0 to 20 mA)

The modulation output (Mod 1) can be adjusted from a 4 to 20 mA output range or to a 0 to 20 mA output range using the *Boil Modulation* setting. The resulting modulation output signal can be converted to a 0 to 5 V (dc), 1 to 5 V (dc), 0 to 10 V (dc), and 2 to 10 V (dc) output using external resistors. The modulation output signal can be converted to a 0 to 135 Ω (W R B) output using a 0 to 135 Ω Converter 005. Refer to the Modulation Output section in Step 4 of the Installation section.

MINIMUM MODULATION

The minimum modulation defines the minimum output signal from the control to the boiler burner. It is based on a percentage of the control's output signal range.

The *Minimum Modulation* setting for boilers with power burners is typically set to 0%.

For boilers with electronic operators, the boiler's input signal range may not match the output signal range of the 263 control. The *Minimum Modulation* setting limits the control output range in order to match the boiler's input range.

To calculate the Minimum Modulation, use the following formulae:

For 4 to 20 mA:

$$\text{Minimum Modulation} = \frac{4 \text{ mA} - \text{Boiler's Minimum Input Signal}}{4 - 20 \text{ mA}} \times 100\%$$

For 0 to 10 V (dc):

$$\text{Minimum Modulation} = \frac{0 \text{ V (dc)} - \text{Boiler's Minimum Input Signal}}{0 - 10 \text{ V (dc)}} \times 100\%$$

For 2 to 10 V (dc):

$$\text{Minimum Modulation} = \frac{2 \text{ V (dc)} - \text{Boiler's Minimum Input Signal}}{2 - 10 \text{ V (dc)}} \times 100\%$$

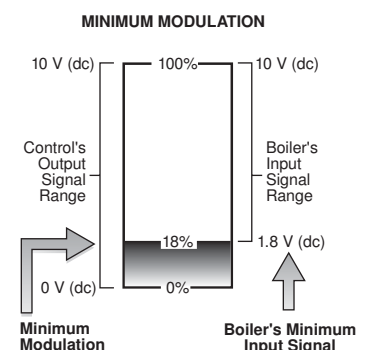

Example 1:

A boiler requires a 1.8 V (dc) signal to fire the boiler at low fire. The boiler can be modulated to 10 V (dc) where it reaches high fire. This means the boiler's input signal range is 1.8 to 10 V (dc). The 263 control has an output signal range of 0 to 20 mA which can be externally converted to 0 to 10 V (dc) using a 500 Ω resistor (Refer to Modulation Output section in Step 4 of the Installation section).

To make the two signal ranges the same, the Minimum Modulation required is:

$$\text{Minimum Modulation} = \frac{0 \text{ V} - 1.8 \text{ V}}{0 \text{ V} - 10 \text{ V}} \times 100\% = 18\%$$

Example 2:

If the boiler's input signal range is 6 to 20 mA the required Minimum Modulation is:

$$\text{Minimum Modulation} = \frac{4 \text{ mA} - 6 \text{ mA}}{4 \text{ mA} - 20 \text{ mA}} \times 100\% = 13\%$$

MAXIMUM MODULATION

The maximum modulation defines the maximum output signal from the control to the boiler burner. It is based on a percentage of the control's output signal range.

The *Maximum Modulation* setting for boilers with power burners is typically set to 100%.

For boilers with electronic operators, the boiler's input signal range may not match the output signal range of the 263 control. The *Maximum Modulation* setting limits the control output range in order to match the boiler's input range.

To calculate the Maximum Modulation, use the following formulae:

For 4 to 20 mA:

$$\text{Maximum Modulation} = \frac{4 \text{ mA} - \text{Boiler's Maximum Input Signal}}{4 - 20 \text{ mA}} \times 100\%$$

For 0 to 10 V (dc):

$$\text{Maximum Modulation} = \frac{0 \text{ V (dc)} - \text{Boiler's Maximum Input Signal}}{0 - 10 \text{ V (dc)}} \times 100\%$$

For 2 to 10 V (dc):

$$\text{Maximum Modulation} = \frac{2 \text{ V (dc)} - \text{Boiler's Maximum Input Signal}}{2 - 10 \text{ V (dc)}} \times 100\%$$

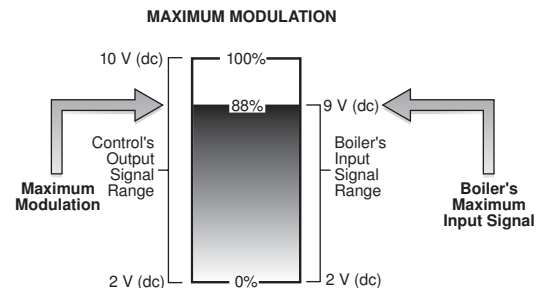

Example 1:

A boiler's input signal range is 2 to 9 V (dc). The 263 control has an output signal range of 2 to 10 V (dc).

To make the two signal ranges the same, the Maximum Modulation required is:

$$\text{Maximum Modulation} = \frac{2 \text{ V} - 9 \text{ V}}{2 \text{ V} - 10 \text{ V}} \times 100\% = 88\%$$

Example 2:

If the boiler's input signal range is 6 to 19 mA the required Maximum Modulation is:

$$\text{Maximum Modulation} = \frac{4 \text{ mA} - 19 \text{ mA}}{4 \text{ mA} - 20 \text{ mA}} \times 100\% = 94\%$$

BOILER MASS

The *Boiler Mass* setting allows the installer to adjust the control to the thermal mass of the type of heat sources used in the application. The modulation of the boiler can become unstable if the incorrect *Boiler Mass* setting is chosen. A key sign of the boiler modulation being unstable is the flame will continue to increase and then decrease in short periods of time. By choosing a lower *Boiler Mass* setting, the boiler response will become more stable.

Lo (1)

The *Lo* setting is selected if the boiler that is used has a low thermal mass. This means that the boiler has a very small water content and has very little metal in the heat exchanger. A boiler that has a low thermal mass comes up to temperature quite rapidly when fired. This is typical of many copper fin-tube boilers. The *Lo Mass* setting provides a fast response to the heating system.

Med (2)

The *Med* setting is selected if the boiler that is used has a medium thermal mass. This means that the boiler either has a large water content and a low metal content or a low water content and a high metal content. This is typical of many modern residential cast iron boilers or steel tube boilers. The *Med Mass* setting provides a moderate response to the heating system.

Hi (3)

The *Hi* setting is selected if the boiler that is used has a high thermal mass. This means that the boiler has both a large water content and a large metal content. A boiler that has a high thermal mass is relatively slow in coming up to temperature. This is typical of many commercial cast iron and steel tube boilers. The *Hi Mass* setting provides a slow response to the heating system.

DIFFERENTIAL

A modulating boiler must be operated with a differential while operating in low fire. The boiler differential is divided around the boiler target temperature. The boiler burner ignites at low fire when the supply water temperature is $\frac{1}{2}$ of the *Boiler Differential* setting below the boiler target temperature. The boiler is shut off in low fire as the supply temperature reaches at least $\frac{1}{2}$ of the differential above the boiler target temperature. With the control, either a fixed or an auto differential may be selected.

When the boiler is modulating above low fire, the differential does not apply. Instead, the modulation output signal is determined using Proportional, Integral and Derivative (PID) logic in order to satisfy the boiler target temperature.

Fixed Differential

If the user desires to have a fixed differential, this is set using the *Boiler Differential* setting in the ADJUST menu.

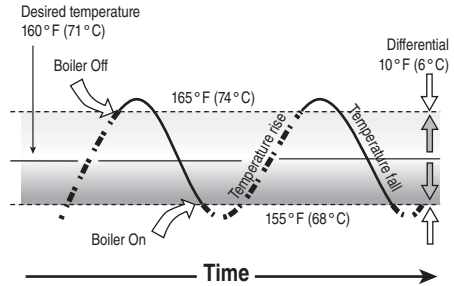

Auto Differential

If the Auto Differential is selected, the control automatically determines the best differential as the load changes. This reduces potential short cycling during light load conditions.

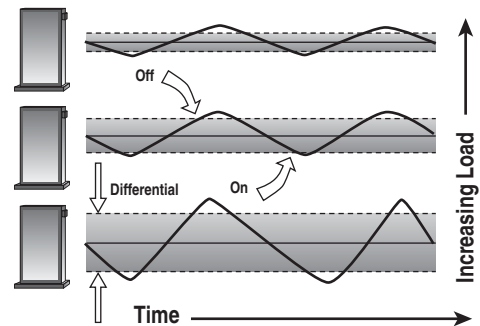

SOFT STOP

It is possible to thermally shock a boiler when it is shut off at high fire. The Soft Stop feature forces the boiler to modulate down to a minimum before turning off. This is designed to prevent large volumes of cold air being introduced into the combustion chamber of the boiler when it is shut off. This can occur in applications where the burner includes a fan.

Once all demands are removed, the control allows for the firing rate to be modulated down to the *Minimum Modulation* setting prior to turning off the burner. This feature is enabled by setting the *Soft Stop / Off DIP* switch to the Soft Stop position. If the *Soft Stop / Off DIP* switch is in the *Off* position, the control turns off the boiler at the current firing rate once all demands are removed.

Section C: Pump Operation

Section C1 Pump Operation

Section C1: Pump Operation

PRIMARY PUMP OPERATION

The primary pump operates under the following conditions:

- A boiler demand is present and the control is not in Warm Weather Shut Down (WWSD).
- A DHW demand is present and DHW MODE is set to 3 or 4.
- A setpoint demand is present and Setpoint MODE is set to 3.

Primary Pump Purge

After a demand is removed, the control continues to operate the primary pump for a period of time. The maximum length of time that the primary pump continues to run is adjustable using the *Primary Pump Purge* setting. The primary pump continues to run until either the purging time has elapsed or the boiler supply temperature drops more than a differential below the *Boiler Minimum* setting.

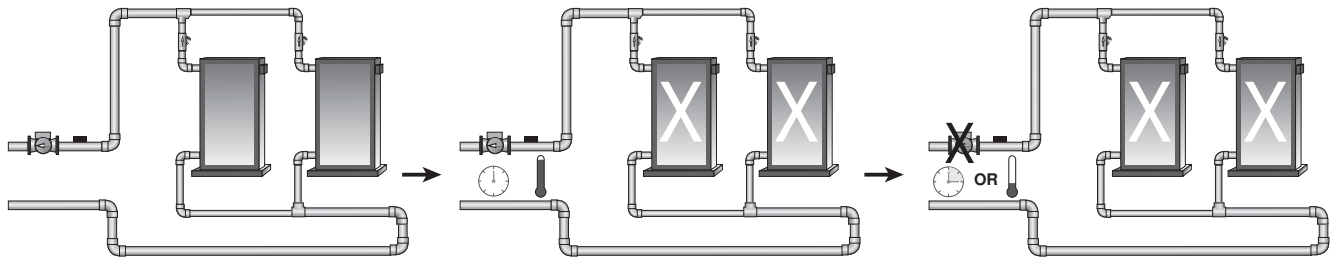

BOILER PUMP OPERATION (MODE 2 ONLY)

When the control is operating in Mode 2 - One Modulating Boiler and Pump, the control can operate the boiler pump on the boiler in addition to the primary pump. The boiler pump turns on prior to the boiler firing (pre-purge) and continues to run after the boiler is turned off (post-purge). The boiler pump pre-purge time is determined by the *Boiler Mass* setting. As the *Boiler Mass* setting is increased, the boiler pump pre-purge time of the boiler also increases. However, if the control is operating based on a setpoint demand, the boiler pump turns on prior to the boiler.

Boiler Pump Purge (Mode 2 Only)

The amount of time that the boiler pump continues to run after the boiler turns off is adjustable using the *Boiler Pump Purge* setting.

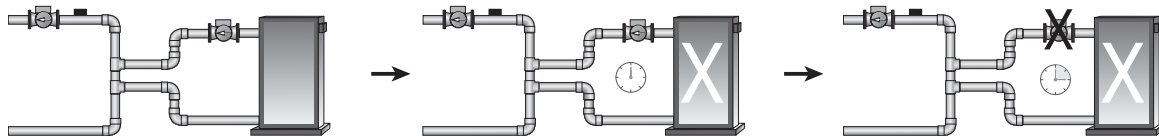

Section D: Boiler Reset Operation

Section D1 Boiler Reset

Section D1: Boiler Reset Operation

BOILER DEMAND

A boiler demand is required in order for the control to provide heat to the heating system. A boiler demand is generated by applying a voltage between 24 and 230 V (ac) across the *Boiler Demand* terminals (1 and 2). Once voltage is applied, the *Boiler Demand* pointer is displayed in the LCD. If the control is not in Warm Weather Shut Down (WWSD), the control closes the primary pump contact. The control calculates a boiler target supply temperature based on the outdoor air temperature and the characterized heating curve settings. The control then fires the boiler(s), if required, to maintain the target supply temperature.

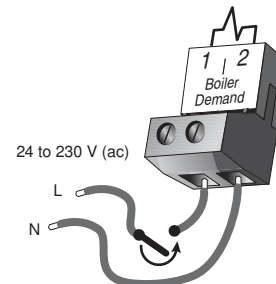

OUTDOOR DESIGN TEMPERATURE

The outdoor design temperature is the outdoor air temperature that is the typical coldest temperature of the year where the building is located. This temperature is used when doing the heat loss calculations for the building. If a cold outdoor design temperature is selected, the boiler supply temperature rises gradually as the outdoor temperature drops. If a warm outdoor design temperature is selected, the boiler supply temperature rises rapidly as the outdoor temperature drops.

CHARACTERIZED HEATING CURVE

The control varies the supply water temperature based on the outdoor air temperature. The control takes into account the type of terminal unit that the system is using. Since different types of terminal units transfer heat to a space using different proportions of radiation, natural convection and forced convection, the supply water temperature must be controlled differently. Once a terminal unit is selected, the control varies the supply water temperature according to the type of terminal unit. This improves the control of the air temperature in the building.

BOILER DESIGN TEMPERATURE

The boiler design supply temperature is the supply water temperature required to heat the building when the outdoor air temperature is as cold as the outdoor design temperature.

BOILER INDOOR DESIGN TEMPERATURE

The indoor design temperature is the room temperature that was used in the original heat loss calculations for the building. This setting establishes the beginning of the characterized heating curve.

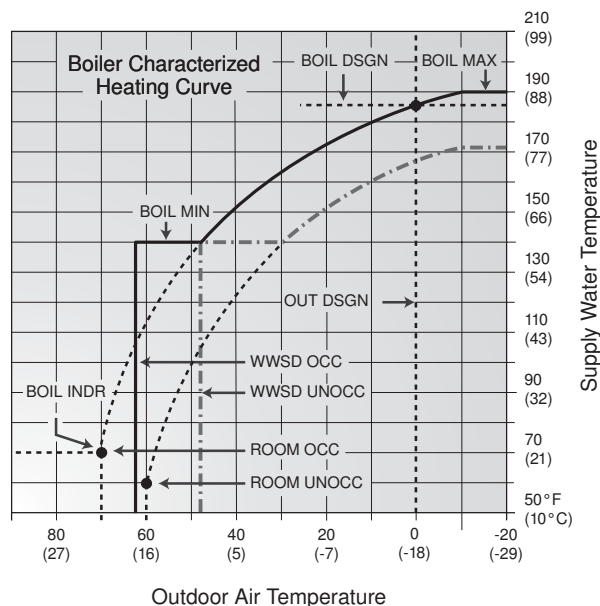

ROOM

The *Room* setting is the desired room temperature for the building and provides a parallel shift of the heating curve. The room temperature desired by the occupants is often different from the design indoor temperature. If the room temperature is not correct, adjusting the *Room* setting increases or decreases the amount of heat available to the building. A *Room* setting is available for both the occupied (day) and unoccupied (night) periods.

INDOOR SENSOR

With the indoor sensor connected, the control is able to sense the actual room temperature. Indoor temperature feedback fine-tunes the supply water temperature in the heating system to maintain room temperature. To adjust the room temperature, use the *Room Occ* or *Room UnOcc* setting in the ADJUST menu at the control.

The indoor sensor is connected to the *InDr* and *Com* terminals (20 and 21). In addition, power must be applied to the *Boiler Demand* terminals (1 and 2) as described in the Boiler Demand section.

If a multiple zone system is used with an indoor sensor, proper placement of the indoor sensor is essential. The indoor sensor should be located in an area which best represents the average air temperature of the zones.

TERMINAL UNITS

The control provides for a selection between six different terminal unit types: two types of radiant floor heat, fancoil, fin-tube convector, radiator and baseboard. When a terminal unit is selected, the control automatically loads the design supply temperature, maximum supply temperature, and minimum supply temperature. The factory defaults are listed below. These factory defaults can be changed to better match the installed system.

Terminal Unit	High Mass Radiant (1)	Low Mass Radiant (2)	Fancoil (3)	Fin-Tube Convector (4)	Radiator (5)	Baseboard (6)
BOIL DSGN	120°F (49°C)	140°F (60°C)	190°F (88°C)	180°F (82°C)	160°F (71°C)	150°F (66°C)
BOIL MAX	140°F (60°C)	160°F (71°C)	210°F (99°C)	200°F (93°C)	180°F (82°C)	170°F (77°C)
BOIL MIN	OFF	OFF	140°F (60°C)	140°F (60°C)	140°F (60°C)	140°F (60°C)

High Mass Radiant (1)

This type of a hydronic radiant floor is embedded in either a thick concrete or gypsum pour. This heating system has a large thermal mass and is slow acting.

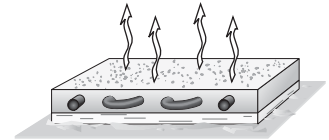

Low Mass Radiant (2)

This type of radiant heating system is either attached to the bottom of a wood sub-floor, suspended in the joist space, or sandwiched between the sub-floor and the surface. This type of radiant system has a relatively low thermal mass and responds faster than a high mass system.

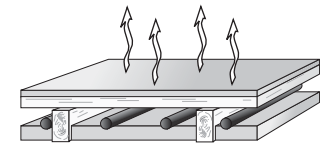

Fancoil (3)

A fancoil terminal unit or Air Handling Unit (AHU) consists of a hydronic heating coil and either a fan or blower. Air is forced across the coil at a constant velocity by the fan or blower, and is then delivered into the building space.

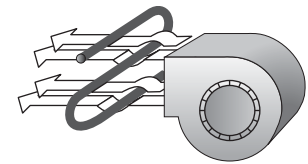

Fin-Tube Convector (4)

A convector terminal unit is made up of a heating element with fins on it. This type of terminal unit relies on the natural convection of air across the heating element to deliver heated air into the space. The amount of natural convection to the space is dependent on the supply water temperature to the heating element and the room air temperature.

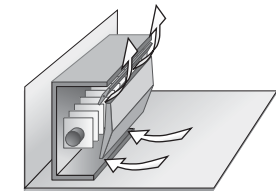

Radiator (5)

A radiator terminal unit has a large heated surface that is exposed to the room. A radiator provides heat to the room through radiant heat transfer and natural convection.

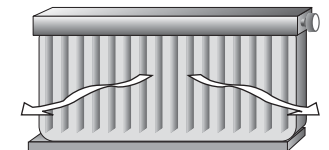

Baseboard (6)

A baseboard terminal unit is similar to a radiator, but has a low profile and is installed at the base of the wall. The proportion of heat transferred by radiation from a baseboard is greater than that from a fin-tube convector.



WARM WEATHER SHUT DOWN (OCC AND UNOCC)

The warm weather shut down (*WWSD*) disables the space heating system during warm outdoor weather. There is a separate *WWSD* for both the occupied and the unoccupied periods. When the outdoor air temperature rises above the *WWSD* setting, the control turns on the *WWSD* pointer in the display. When the control is in *WWSD*, the *Boiler Demand* pointer is displayed if there is a boiler demand. However, the control does not operate the heating system to satisfy this demand. The control does respond to a *DHW* demand or a *setpoint* demand and operates as described in sections E and F.

BOOST

When the control changes from the unoccupied mode to the occupied mode, it enters into a boosting mode. In this mode, the supply water temperature to the system is raised above its normal values for a period of time to provide a faster recovery from the setback temperature of the building. The maximum length of the boost is selected using the *BST* setting.

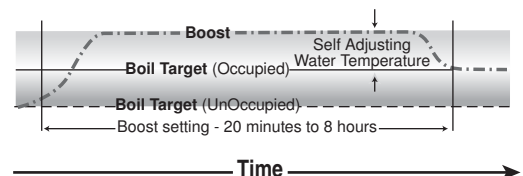

Typical settings for the boost function vary between 30 minutes and two hours for buildings that have a fast responding heating system. For buildings that have a slow responding heating system, a setting between four hours and eight hours is typical. After a boost time is selected, the setback timer must be adjusted to come out of setback some time in advance of the desired occupied time. This time in advance is normally the same as the *BST* setting.

If the building is not up to temperature at the correct time, the *BST* setting should be lengthened and the setback timer should be adjusted accordingly. If the building is up to temperature before the required time, the *BST* setting should be shortened and the setback timer should be adjusted accordingly. If the system is operating near its design conditions or if the supply water temperatures are being limited by settings made in the control, the time required to bring the building up to temperature may be longer than expected.

Section E: Domestic Hot Water Operation

Section E1
Domestic Hot Water (DHW)

Section E2
DHW with Low Temperature Boilers

Section E1: Domestic Hot Water (DHW)

DHW DEMAND

A *DHW Demand* is generated on the control by using one of two methods: either an external DHW demand from an aquastat or an internal demand from a 10K tekmar sensor. If an external DHW demand and a DHW sensor are present simultaneously, the control ignores the external DHW demand.

External Demand (DHW Sensor DIP switch = Off)

A DHW Demand is required in order for the control to provide heat to the DHW system. A DHW aquastat or setpoint control is used as a switch in the DHW demand circuit. Once the control detects a DHW demand, the DHW Demand pointer turns on in the LCD and the control operates the boiler to provide a sufficient boiler supply water temperature to the DHW tank. The control operates the pumps as described below.

The control registers a DHW Demand when a voltage between 24 and 230 V (ac) is applied across the *DHW Demand* terminals (3 and 4).

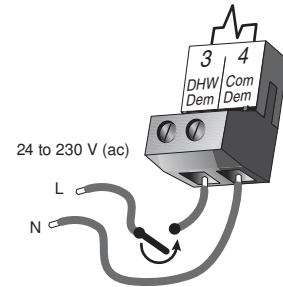

Internal Demand (DHW Sensor DIP switch = DHW Sensor)

The control can use a DHW sensor instead of an aquastat to maintain temperature in a DHW tank. The *DHW* setting in the ADJUST menu is used to set the desired DHW tank temperature. When the temperature at the DHW sensor drops below the *DHW Tank* setting by $\frac{1}{2}$ the *DHW Differential* setting, the DHW Demand pointer turns on in the LCD and the control operates as described below.

An advantage to using the DHW sensor is that the control can display the current DHW tank temperature. Also, the control can control the DHW temperature with more accuracy than when using an aquastat.

The control registers a demand for DHW when the *DHW Sensor / Off* DIP switch is set to *DHW Sensor* and a sensor is connected across the *Com* and the *DHW* terminals (17 and 19).

BOILER TARGET DURING DHW GENERATION

The boiler target (*Boil TARG*) temperature during DHW operation depends on whether an external or internal demand is present. The DHW demand overrides the reset water temperature, except when the reset water temperature requirement is higher than that of the DHW tank.

External Demand (DHW Sensor DIP Switch = Off)

If the control receives a DHW demand through an external device such as an aquastat, the boiler target temperature is at least as hot as the DHW heat exchange setting (*DHW XCHG*).

Internal Demand (DHW Sensor DIP Switch = DHW Sensor)

If the control receives a DHW demand from a DHW sensor attached to the *Com* and the *DHW* terminals (17 and 19), the boiler target temperature is calculated based on the *DHW* setting.

DHW MODE AND PRIORITY OPERATION

The control has four different modes of DHW operation, which depends on the piping arrangement of the DHW tank. It is often desirable to limit or even stop the flow of heat to the heating system when the DHW tank calls for heat. This allows for a faster recovery of the DHW tank.

DHW Mode 1 - DHW in Parallel no Priority

When a *DHW Demand* is present, the *DHW Pmp / Vlv* contact (terminals 9 and 10) closes. The primary pump contact does not turn on, but may operate based on a boiler demand.

It is assumed that the DHW pump will provide adequate flow through the heat exchanger and the boiler.

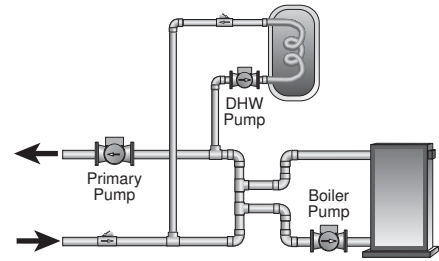

DHW Mode 2 - DHW in Parallel with Priority

When a *DHW Demand* is present, the *DHW Pmp / Vlv* contact (terminals 9 and 10) closes and the primary pump contact is opened.

It is assumed that the DHW pump will provide adequate flow through the heat exchanger and the boiler.

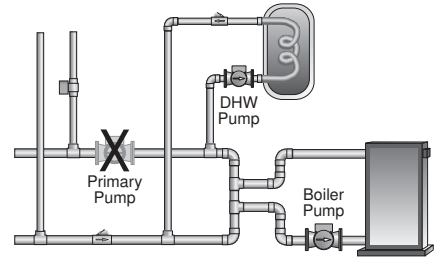

DHW Mode 3 - DHW in Primary / Secondary no Priority

When a *DHW Demand* is present, the *DHW Pmp / Vlv* contact (terminals 9 and 10) is closed and the primary pump contact is closed.

This mode can be used if a DHW tank is piped in direct return and a DHW valve is installed.

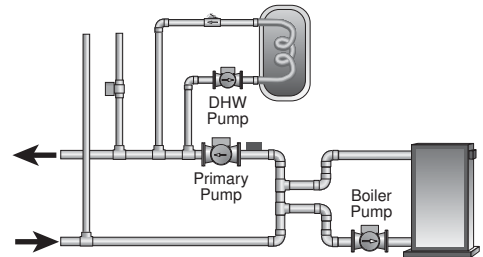

DHW Mode 4 - DHW in Primary / Secondary with Priority

When a *DHW Demand* is present, the *DHW Pmp / Vlv* contact (terminals 9 and 10) is closed and the primary pump contact is closed. Priority can only be obtained using external wiring. During a priority override, the *DHW Pmp / Vlv* contact is opened until the heating system has recovered before returning to DHW operation.

This mode can be used if a DHW tank is piped in direct return and a DHW valve is installed.

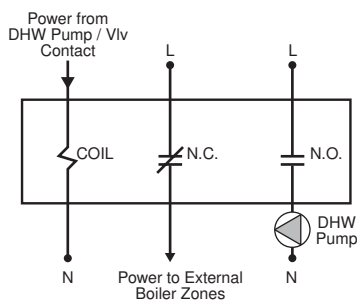

DHW MODE 4
External Priority
Interlock

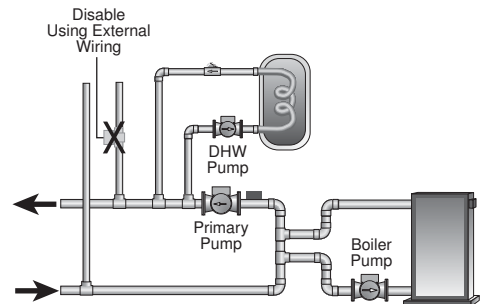

DHW PRIORITY OVERRIDE

The *DHW Priority Override* applies to DHW modes 2 and 4. To prevent the building from cooling off too much or the possibility of a potential freeze up during DHW priority, the control limits the amount of time for DHW priority. As the outdoor air temperature becomes colder, the length of time that the control provides DHW priority is reduced. Once the allowed time for priority has elapsed, the control overrides the DHW priority and resumes space heating.

To provide external DHW priority, the space heating zones must be interlocked with the *DHW Pmp / Vlv* contact. During demands, the *DHW Pmp / Vlv* contact must remove any power to all space heating zone valves or zone pumps.

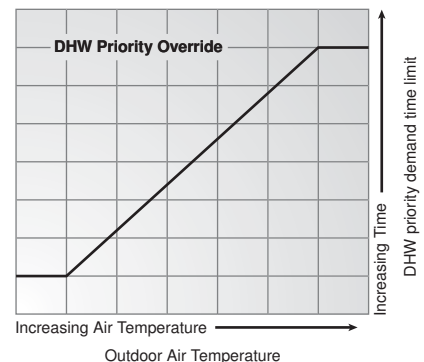

CONDITIONAL DHW PRIORITY

The Conditional DHW Priority Override applies to *DHW MODE 2* and *4*. If the boiler supply temperature is maintained at or above the required temperature during DHW generation, this indicates that the boiler(s) has enough capacity for DHW and possibly heating as well. As long as the boiler supply temperature is maintained near its target, DHW and heating occurs simultaneously.

DHW POST PURGE

After the *DHW Demand* is removed, the control performs a purge on the boiler(s). The control shuts off the boiler(s) and continues to operate either the DHW pump or the DHW valve and the system and boiler pump if applicable. This purges the residual heat from the boiler(s) into the DHW tank. The control continues this purge for a maximum of four minutes or until the boiler supply water temperature drops 20°F (11°C) below the boiler target temperature during the DHW operation. The control also stops the purge if the boiler supply temperature drops below the current boiler target temperature.

DHW MIXING PURGE

After DHW operation, the boiler(s) is extremely hot. At the same time, the heating zones may have cooled off considerably after being off for a period of time. To avoid thermally shocking the boiler(s) after DHW in parallel with priority (*DHW MODE 2*), the control shuts off the boiler(s), but continues to operate the DHW pump while restarting the heating system. This allows some of the DHW return water to mix with the cool return water from the zones and temper the boiler return water.

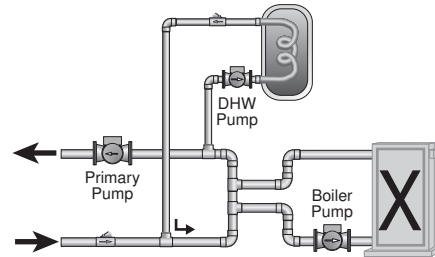

DHW DURING UNOCCUPIED

The DHW operation during an unoccupied period (*UNOCC*) depends on the type of *DHW Demand* that the control is receiving. For this function to operate, the control must have the *Setback / None* DIP switch set to *Setback*.

External Demand (DHW Sensor DIP Switch = Off)

If an external *DHW Demand* is used, the control can either continue operation of the DHW system as it would during the occupied period or the control can ignore a call for DHW as long as the control is in an unoccupied mode.

Internal Demand (DHW Sensor DIP Switch = DHW Sensor)

If an internal *DHW Demand* is used, a *DHW UNOCC* temperature can be set. This is the temperature that the tank maintains as long as the control is in an unoccupied mode. The *DHW UNOCC* can also be set to *Off* so that a call for DHW is ignored as long as the control is in an unoccupied mode.

NUMBER OF BOILERS USED FOR DHW GENERATION

The number of boilers used for DHW generation can be selected to either one or two. This setting is only available when the control is operating in Mode 1 - Two ON / OFF Stages.

Section E2: DHW with Low Temperature Boilers

If DHW is to be incorporated into a low temperature system such as a radiant heating system, a mixing device is often installed to isolate the high DHW supply temperature from the lower system temperature. If a mixing device is not installed, high temperature water could be supplied to the low temperature system while trying to satisfy the DHW demand. This may result in damage to the low temperature heating system. The control is capable of providing DHW in such a system while maximizing the chance that the temperature in the heating system does not exceed its allowed *Boiler Maximum* setting.

To prevent high temperature water from being introduced into the heating system, the primary pump (*Prim P1*) must be turned off during a call for DHW. To do this, the control must be set to *DHW MODE 2* or *DHW MODE 4* and *Boil MIN* must be set to *OFF*.

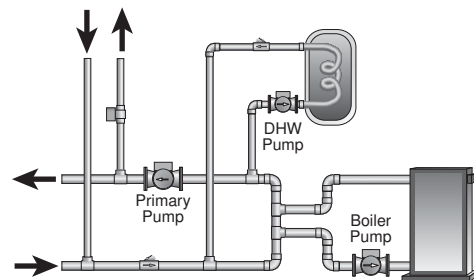

DHW MODE 2 OPERATION

On a call for DHW, the control provides DHW priority by shutting off the primary pump (*Prim P1*) for a period of time. This time is based on the outdoor air temperature as described in the DHW Priority Override section. However, if the *DHW Demand* is not satisfied within the allotted time, the boiler(s) shuts off and the heat of the boiler is purged into the DHW tank.

Once the boiler supply temperature is sufficiently reduced, the *DHW Pmp / Vlv* contact shuts off. The heating system is turned on for a period of time to prevent the building from cooling off. After a period of heating, and if the *DHW Demand* is still present, the control shuts off the heating system and provides heat to the DHW tank once again.

For correct operation, close attention must be paid to the mechanical layout of the system. When the control turns off the primary pump (*Prim P1*), flow to the heating system must stop. If flow is not stopped, the temperature in the heating system can exceed the maximum desired temperature and can result in damage to the heating system.

DHW MODE 4 OPERATION

In DHW MODE 4, the space heating zones must be prevented from coming on during DHW demands using external wiring. This can be done using an external relay to remove power from zone pumps or zone valves while a DHW Demand is present. This external relay is interlocked with the *DHW Pmp / Vlv* contact.

During a DHW Demand, the control closes the primary pump (*Prim P1*) contact and the *DHW Pmp / Vlv* contact. Once the DHW Demand is removed, or during a DHW priority override, the *DHW Pmp / Vlv* contact is opened, and the external wiring should allow the space heating zones to operate.

There is no mixing purge available in DHW MODE 4. After DHW priority, the boiler supply water temperature may exceed the design water temperature of the space heating system and can result in damage to the heating system.

Section F: Setpoint Operation

Section F1 Setpoint Operation

Section F1: Setpoint

SETPOINT

The control can operate to satisfy the requirements of a setpoint load in addition to a space heating load and a DHW load. A setpoint load overrides the current outdoor reset temperature and *WWSD* setting in order to provide heat to the setpoint load.

SETPOINT DEMAND

A Setpoint Demand is required in order for the control to provide heat to the setpoint load. The control registers a setpoint demand when a voltage between 24 and 230 V (ac) is applied across the *Setp Dem* and *Com Dem* terminals (5 and 4). Once voltage is applied, the Setpoint Demand pointer turns on in the LCD. The control operates the boiler(s) to maintain at least the *Setpoint* setting.

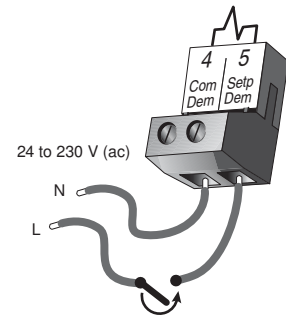

BOILER TARGET DURING SETPOINT

The boiler target temperature during a setpoint demand is increased to at least the *Setpoint* setting. This temperature is maintained as long as the control has a setpoint demand.

SETPOINT MODES

Mode 1 – Setpoint in Parallel

Whenever a setpoint demand is present, the boiler(s) is operated to maintain the setpoint target.

It is assumed that the Setpoint pump will provide adequate flow through the heat exchanger and the boiler.

Mode 2 – Setpoint in Parallel with Priority

Whenever a setpoint demand is present, the boiler(s) is operated to maintain setpoint and the primary pump (*Prim P1*) is turned off.

It is assumed that the Setpoint pump will provide adequate flow through the heat exchanger and the boiler.

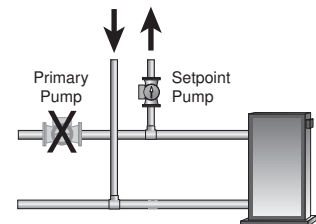

Mode 3 – Primary Pump during Setpoint

Whenever a setpoint demand is present, the primary pump (*Prim P1*) is turned on and the boiler(s) is operated to maintain setpoint target.

SETPOINT PRIORITY OVERRIDE

The setpoint has a *Priority Override* while in *SETP MODE 2*. In order to prevent the building from cooling off too much or the possibility of a potential freeze up during setpoint priority, the control limits the amount of time for setpoint priority. As the outdoor air temperature becomes colder, the length of time the control provides setpoint priority is reduced. Once the allowed time for priority has elapsed, the control overrides the setpoint priority and operates setpoint and heating simultaneously by turning on the primary pump (*Prim P1*).

CONDITIONAL SETPOINT PRIORITY

If the boiler(s) supply temperature is maintained at or above the required temperature during setpoint generation, this indicates that the boiler(s) has enough capacity for setpoint and possibly heating as well. As long as the boiler target temperature is maintained, setpoint and heating occur at the same time.

Installation

⚠ CAUTION

Improper installation and operation of this control could result in damage to the equipment and possibly even personal injury. It is your responsibility to ensure that this control is safely installed according to all applicable codes and standards. This electronic control is not intended for uses as a primary limit control. Other controls that are intended and certified as safety limits must be placed into the control circuit. Do not open the control. Refer to qualified personnel for servicing. Opening voids warranty and could result in damage to the equipment and possibly even personal injury.

STEP ONE GETTING READY

Check the contents of this package. If any of the contents listed are missing or damaged, please contact your wholesaler or tekmar sales representative for assistance.

Type 263 includes: One Boiler Control 263, One Outdoor Sensor 070, One Universal Sensor 082, One 500 Ω Resistor, Data Brochures D 263, D 070, D 001, Application Brochure A 263.

Note: Carefully read the details of the Sequence of Operation to ensure that you have chosen the proper control for your application.

STEP TWO MOUNTING THE BASE

Remove the control from its base by pressing down on the release clip in the wiring chamber and sliding the control away from it. The base is then mounted in accordance with the instructions in the Data Brochure D 001.

⚠ STEP THREE ROUGH-IN WIRING

All electrical wiring terminates in the control base wiring chamber. The base has standard $\frac{7}{8}$ in (22 mm) knockouts, which accept common wiring hardware and conduit fittings. Before removing the knockouts, check the wiring diagram and select those sections of the chamber with common voltages. Do not allow the wiring to cross between sections, as the wires will interfere with safety dividers which should be installed at a later time.

Power must not be applied to any of the wires during the rough-in wiring stage.

- All wires are to be stripped to a length of $\frac{3}{8}$ in (9 mm) to ensure proper connection to the control.
- Install the Outdoor Sensor 070 according to the installation instructions in the Data Brochure D 070 and run the wiring back to the control.
- Install the Boiler Supply Sensor 082 according to the installation instructions in the Data Brochure D 070 and run the wiring back to the control.
- If a DHW Sensor 082 is used, install the sensor according to the installation instructions in the Data Brochure D 070 and run the wiring back to the control.
- If an Indoor Sensor 076 or 077 is used, install the indoor sensor according to the instructions in the Data Brochure D 074 and run the wiring back to the control.
- Run wire from other system components (pumps, boilers, etc.) to the control.
- Run wires from the 115 V (ac) power to the control. Use a clean power source with a 15 A circuit to ensure proper operation. Multi-strand 16 AWG wire is recommended for all 115 V (ac) wiring due to its superior flexibility and ease of installation into the terminals.

STEP FOUR — ELECTRICAL CONNECTIONS TO THE CONTROL

General

The installer should test to confirm that no voltage is present at any of the wires. Push the control into the base and slide it down until it snaps firmly into place.

⚠ Powered Input Connections

115 V (ac) Power

Connect the 115 V (ac) power supply to the *Power L* and *Power N* terminals (7 and 8). This connection provides power to the microprocessor and display of the control. As well, this connection provides power to the *Prim P1* terminal (6) from the *Power L* terminal (7).

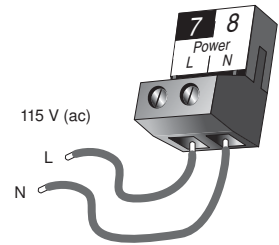

Boiler Demand

To generate a *Boiler Demand*, a voltage between 24 V (ac) and 230 V (ac) must be applied across the *Boiler Demand* terminals (1 and 2).

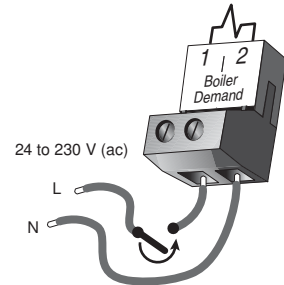

DHW Demand

To generate a *DHW Demand*, a voltage between 24 V (ac) and 230 V (ac) must be applied across the *DHW Dem* and *Com Dem* terminals (3 and 4).

Caution: The same power supply must be used to power both the DHW Demand and the Setpoint Demand circuits since they both share the *Com Dem* terminal.

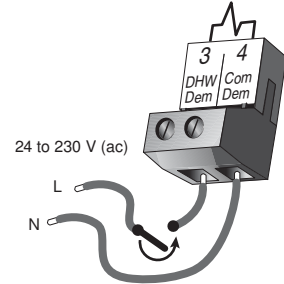

Setpoint Demand

To generate a *Setpoint Demand*, a voltage between 24 V (ac) and 230 V (ac) must be applied across the *Setp Dem* and *Com Dem* terminals (5 and 4).

Caution: The same power supply must be used to power both the DHW Demand and the Setpoint Demand circuits since they both share the *Com Dem* terminal.

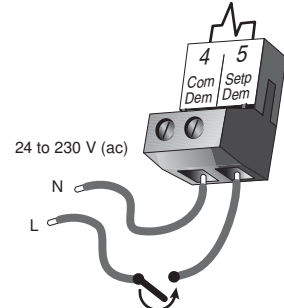

Output Connections

Primary Pump Contact (Prim P1)

The *Prim P1* output terminal (6) is a powered output. When the relay in the control closes, 115 V (ac) is provided to the *Prim P1* terminal (6) from the *Power L* terminal (7). To operate the primary pump, connect one side of the primary pump circuit to terminal 6 and the second side of the pump circuit to the neutral (*Power N*) side of the 115 V (ac) power supply.

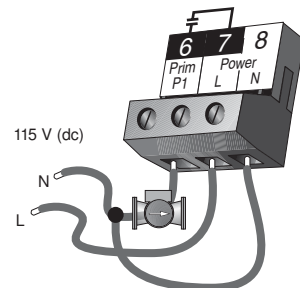

DHW Pmp / Vlv Contact

The *DHW Pmp / Vlv* terminals (9 and 10) are an isolated output. There is no power available on these terminals from the control. These terminals are to be used as a switch to either make or break power to the DHW pump or the DHW valve. Since this is an isolated contact, it may switch a voltage between 24 V (ac) and 230 V (ac).

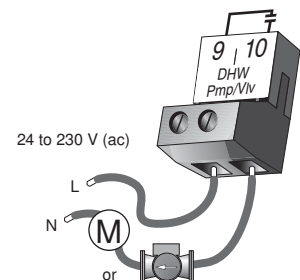

Relay 1 Contact

Mode 1 - Two ON / OFF Stages

The *Relay 1* terminals (11 and 12) are isolated outputs in the control. There is no power available on these terminals from the control. These terminals are to be used as a switch to either make or break power to a boiler or a Lo fire stage on a single boiler. Since this is an isolated contact, it may switch a voltage between 24 V (ac) and 230 V (ac).

Mode 2 - One Modulating Boiler and Pump

The *Relay 1* terminals (11 and 12) are isolated outputs in the control. There is no power available on these terminals from the control. These terminals are to be used as a switch to enable the modulating boiler to operate at Lo fire. Since this is an isolated contact, it may switch a voltage between 24 V (ac) and 230 V (ac).

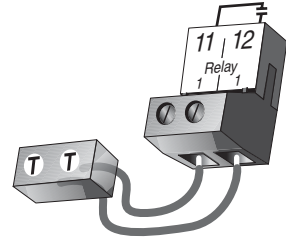

Relay 2 / P2 Contact

Mode 1 - Two ON / OFF Stages

The *Relay 2 / P2* terminals (13 and 14) are isolated output in the control. There is no power available on these terminals from the control. These terminals are to be used as a switch to either make or break power to a boiler or a Hi fire stage on a single boiler. Since this is an isolated contact, it may switch a voltage between 24 V (ac) and 230 V (ac).

Mode 2 - One Modulating Boiler and Pump

The *Relay 2 / P2* terminals (13 and 14) are isolated output in the control. There is no power available on these terminals from the control. These terminals are to be used as a switch to either make or break power to a boiler pump. Since this is an isolated contact, it may switch a voltage between 24 V (ac) and 230 V (ac).

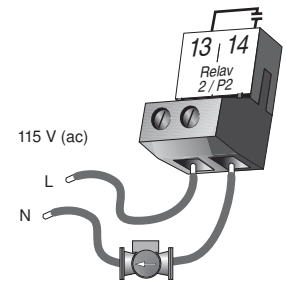
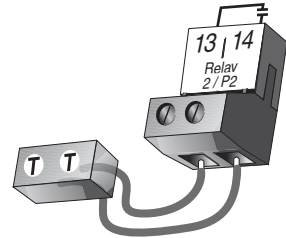

Modulation Output

The Modulation Output *Mod 1* terminals (15 and 16) provide a 4 to 20 mA or a 0 to 20 mA output to the boiler. The modulating outputs replace any mechanical operator such as a T991. Observe polarity when connecting the control to the boiler.

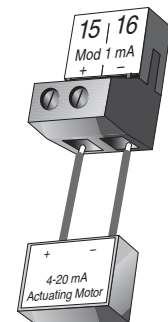

Connection to Operate a 4 - 20 mA Device

The 4 to 20 mA output can be converted to 2 to 10 V (dc) using an external 500 Ω resistor across the *Modulation Output* terminals (15 and 16).

The 4 to 20 mA output can be converted to 1 to 5 V (dc) using an external 250 Ω resistor across the *Modulation Output* terminals (15 and 16).

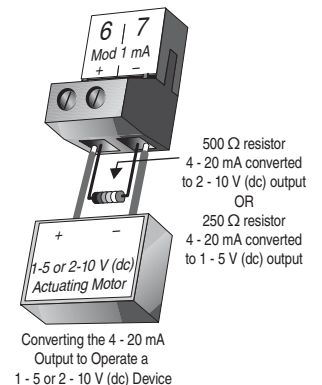

The 0 to 20 mA output can be converted to 0 to 10 V (dc) using an external 500 Ω resistor across the *Modulation Output* terminals (15 and 16).

The 0 to 20 mA output can be converted to 0 to 5 V (dc) using an external 250 Ω resistor across the *Modulation Output* terminals.

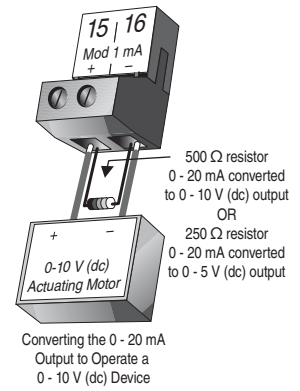

The 4 to 20 mA output can be converted to a 0 to 135 Ω output for a Modutrol IV™ gas valve actuating motor using a tekmar 0 to 135 Ω Converter 005 (sold separately).

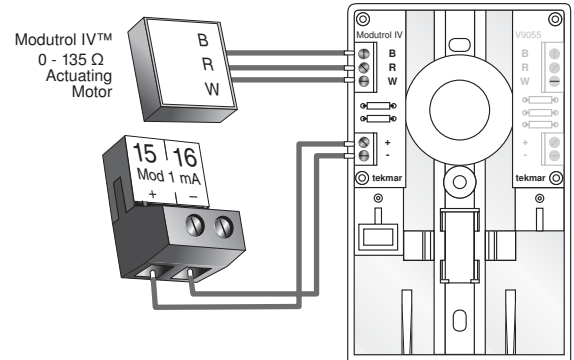

The 4 to 20 mA output can be converted to a 0 to 135 Ω output for a V9055™ gas valve actuating motor using a tekmar 0 to 135 Ω Converter 005 (sold separately).

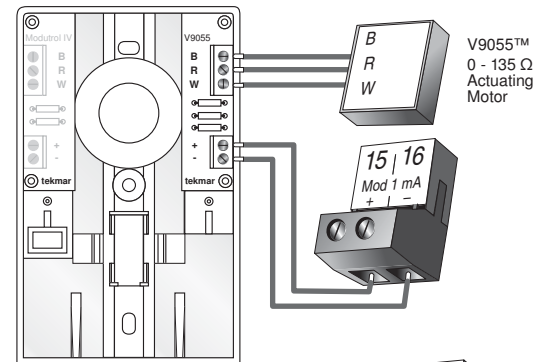

SENSOR AND UNPOWERED INPUT CONNECTIONS

Do not apply power to these terminals as this will damage the control.

Outdoor Sensor

Connect the two wires from the Outdoor Sensor 070 to the *Com* and *Out* terminals (21 and 23). The outdoor sensor is used by the control to measure the outdoor air temperature.

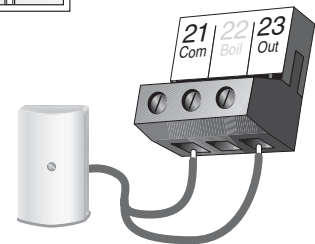

Boiler Supply Sensor

Connect the two wires from the Boiler Supply Sensor 082 to the *Com* and *Boil* terminals (21 and 22). The boiler supply sensor is used by the control to measure the boiler supply water temperature.

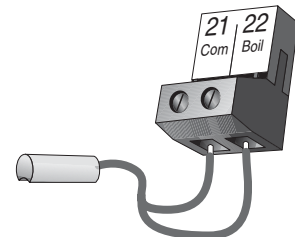

DHW Sensor

Connect the two wires from the DHW Sensor 082 to the *Com* and *DHW* terminals (17 and 19). The DHW Sensor is used by the control to measure the DHW tank temperature.

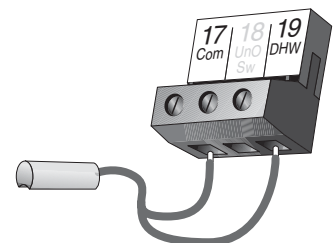

™Modutrol IV and V9055 are trademarks of Honeywell, Inc.

UnOccupied Switch

If an external timer (tekmar Timer 032) or switch is used, connect the two wires from the external switch to the *Com* and *UnO Sw* terminals (17 and 18). When these two terminals are shorted together, the control registers an unoccupied (*UNOCC*) signal.

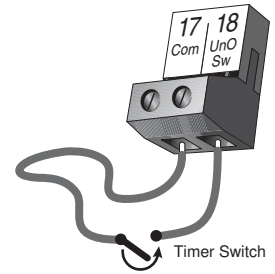

STEP FIVE TESTING THE WIRING

⚠ General

Each terminal block must be unplugged from its header on the control before power is applied for testing. To remove the terminal block, pull straight down from the control.

The following tests are to be performed using standard testing practices and procedures and should only be carried out by properly trained and experienced persons.

A good quality electrical test meter, capable of reading from at least 0 to 300 V (ac) and at least 0 to 2,000,000 Ω , is essential to properly test the wiring and sensors.

⚠ Test The Sensors

In order to test the sensors, the actual temperature at each sensor location must be measured. A good quality digital thermometer with a surface temperature probe is recommended for ease of use and accuracy. Where a digital thermometer is not available, a spare sensor can be strapped alongside the one to be tested and the readings compared. Test the sensors according to the instructions in the Data Brochure D 070.

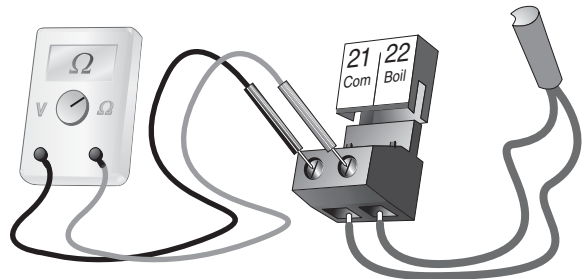

⚠ Test The Power Supply

Make sure exposed wires and bare terminals are not in contact with other wires or grounded surfaces. Turn on the power and measure the voltage between the *Power L* and *Power N* terminals (7 and 8) using an AC voltmeter, the reading should be between 103.5 and 126.5 V (ac).

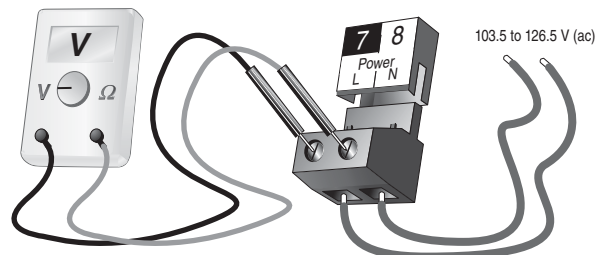

Test the Powered Inputs

Boiler Demand

If a boiler demand is used, measure the voltage between the *Boil Demand* terminals (1 and 2). When the boiler demand device calls for heat, between 20 and 260 V (ac) should be measured at the terminals. When the boiler demand device is off, less than 5 V (ac) should be measured.

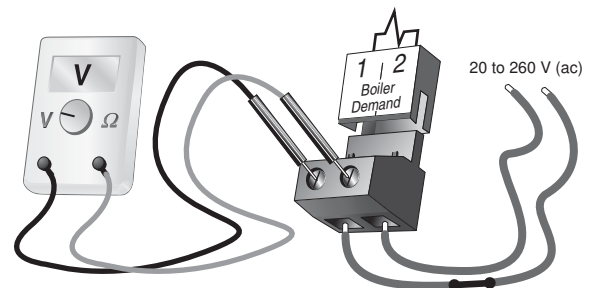

DHW Demand

If a DHW demand is used, measure the voltage between the *DHW Dem* and the *Com Dem* terminals (3 and 4). When the DHW demand device calls for heat, between 20 and 260 V (ac) should be measured at the terminals. When the DHW demand device is off, less than 5 V (ac) should be measured.

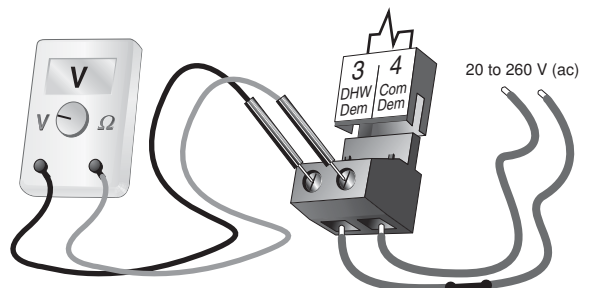

Setpoint Demand

If a setpoint demand is used, measure the voltage between the *Setp Dem* and the *Com Dem* terminals (5 and 4). When the setpoint demand device calls for heat, between 20 and 260 V (ac) should be measured at the terminals. When the setpoint demand device is off, less than 5 V (ac) should be measured.

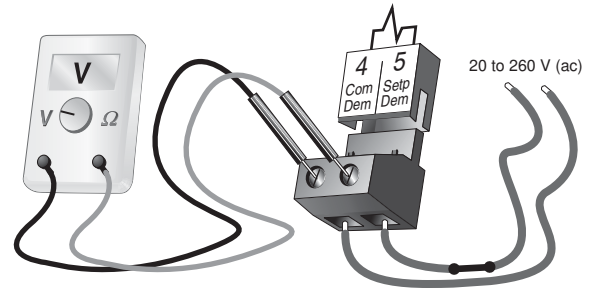

TEST THE OUTPUTS

Primary Pump (Prim P1)

If a primary pump is connected to the *Prim P1* terminal (6), make sure that power to the terminal block is off and install a jumper between the *Power L* and *Prim P1* terminals (7 and 6). When power is applied to the *Power L* and *Power N* terminals (7 and 8), the primary pump should start. If the pump does not turn on, check the wiring between the terminal block and pump and refer to any installation or troubleshooting information supplied with the pump. If the pump operates properly, disconnect the power and remove the jumper.

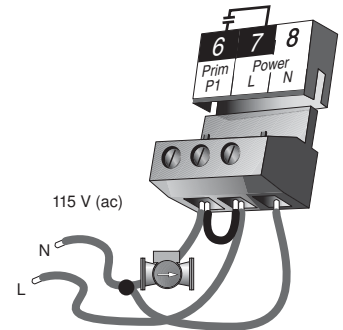

Relay 1 Contact

Mode 1 - Two ON / OFF Stages

If an on / off boiler or a Lo fire boiler stage is connected to the *Relay 1* terminals (11 and 12), make sure power to the boiler circuit is off, and install a jumper between the terminals. When the boiler circuit is powered up, the boiler should fire. If the boiler does not turn on, refer to any installation or troubleshooting information supplied with the boiler. (The boiler may have a flow switch that prevents firing until the primary pump (*Prim P1*) or boiler pump (*P2*) is running). If the boiler operates properly, disconnect the power and remove the jumper.

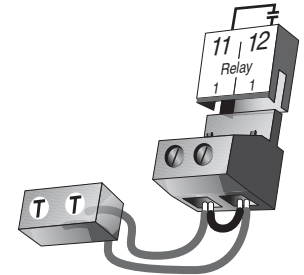

Mode 2 - One Modulating Boiler and Pump

If a modulating boiler is connected to the *Relay 1* terminals (11 and 12), make sure power to the boiler circuit is off, and install a jumper between the terminals. When the boiler circuit is powered up, the boiler should ignite and operate at Lo fire. The boiler may require a modulating signal before firing. If the boiler does not turn on, refer to any installation or troubleshooting information supplied with the boiler. (The boiler may have a flow switch that prevents firing until the primary pump (*Prim P1*) or boiler pump (*P2*) is running). If the boiler operates properly, disconnect the power and remove the jumper.

Relay / P2 Contact

Mode 1 - Two ON / OFF Stages

If an on / off boiler is connected to the *Relay 2 / P2* terminals (13 and 14), make sure power to the boiler circuit is off, and install a jumper between the terminals. When the boiler circuit is powered up, the boiler should fire. If the boiler does not turn on, refer to any installation or troubleshooting information supplied with the boiler. (The boiler may have a flow switch that prevents firing until the primary pump (*Prim P1*) or boiler pump (*P2*) is running). If the boiler operates properly, disconnect the power and remove the jumper.

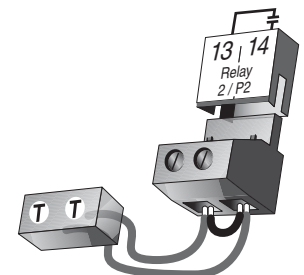

To test the second stage of a two stage boiler, the Lo fire must firing before the Hi fire will operate. Once the Lo stage is firing, test the Hi fire stage in the same way as an on / off boiler.

Mode 2 - One Modulating Boiler and Pump

If a boiler pump is connected to the *Relay 2 / P2* terminals (13 and 14), make sure that power to the terminal block is off and install a jumper between the terminals. When power is applied to circuit, the boiler pump should start. If the pump does not turn on, check the wiring between the terminal block and pump and refer to any installation or troubleshooting information supplied with the pump. If the pump operates properly, disconnect the power and remove the jumper.

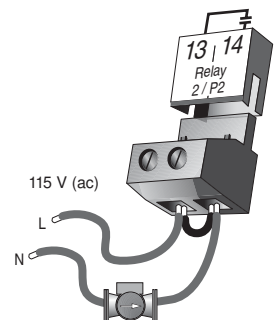

DHW Pump Or Valve (DHW Pmp / Vlv)

If a DHW pump or DHW valve is connected to the *DHW Pmp / Vlv* terminals (9 and 10), make sure the power to the pump or valve circuit is off and install a jumper between those terminals. When the DHW circuit is powered up, the DHW pump should turn on or the DHW valve should open completely. If the DHW pump or valve fails to operate, check the wiring between the terminals and the pump or valve and refer to any installation or troubleshooting information supplied with these devices. If the DHW pump or valve operates correctly, disconnect the power and remove the jumper.

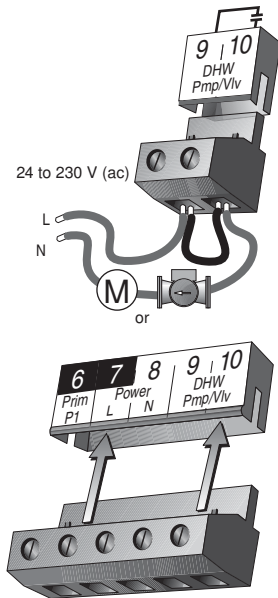

CONNECTING THE CONTROL

Make sure all power to the devices and terminal blocks is off, and remove any remaining jumpers from the terminals.

Reconnect the terminal blocks to the control by carefully aligning them with their respective headers on the control, and then pushing the terminal blocks into the headers. The terminal blocks should snap firmly into place.

Install the supplied safety dividers between the unpowered sensor inputs and the powered or 115 V (ac) wiring chambers.

Apply power to the control. The operation of the control on power up is described in the Sequence of Operation section of the brochure.

TEST THE MODULATING OUTPUT

If a modulating device is used, connect an ammeter to the modulating output *Mod 1* terminals (15 and 16) and observe the current reading during operation. For example, when using a 4-20 mA output, the initial percentage output is zero and the meter should read 4 mA. As the Boiler Modulation in the VIEW menu increases, the meter reading should increase until the Boiler Modulation reaches 100% at which point the meter should read 20 mA. When the 4-20 mA modulation decreases, the meter should start at 20 mA and eventually reach 4 mA when the display shows 0% Boiler Modulation.



Cleaning the Control

The control's exterior can be cleaned using a damp cloth. Moisten the cloth with water and wring out prior to wiping control. Do not use solvents or cleaning solutions.

DIP Switch Settings

GENERAL

The DIP switch settings on the control are very important and should be set to the appropriate settings prior to making any adjustments to the control through the User Interface. The DIP switch settings change the items that are available to be viewed and / or adjusted in the User Interface.

If a DIP switch is changed while the control is powered up, the control responds to the change in setting by returning the display to the VIEW menu.

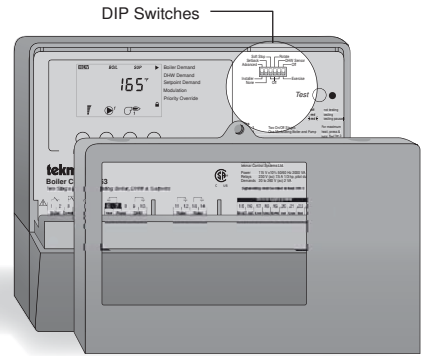

Advanced / Installer

The *Advanced / Installer* DIP switch selects the access level of the control. In the *Installer* access level, a limited number of items may be viewed and / or adjusted. In the *Advanced* access level, all items may be viewed and / or adjusted.

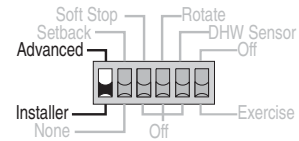

Setback / None

The *Setback / None* DIP switch enables and disables the setback functions of the control. When the DIP switch is set to the *None* or down position, the control ignores any external setback signal, and its user interface does not display the Unoccupied adjustments.

When the DIP switch is set to the *Setback* position, the internal clock in the control is enabled. The control also responds to an external setback signal generated on the *UnO Sw* terminal.

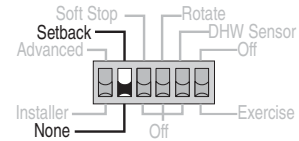

Soft Stop / Off (MODE 2 - One Modulating Boiler and Pump Only)

The *Soft Stop / Off* DIP switch selects whether or not to provide the boiler with a *Soft Stop*. If the switch is set *Soft Stop*, the control modulates the burner down to minimum modulation and holds it at the minimum for an amount of time before shutting off the burner. If the switch is set to *Off*, the control turns off the burner at the current firing rate once a demand is removed.

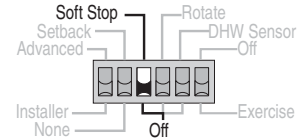

Rotate / Off (MODE 1 - Two On / Off Stages Only)

The *Rotate / Off* DIP switch selects whether or not the control is to provide Equal Run Time Rotation of the boiler stages. If the switch is set to *Rotate*, the stages will be rotated accordingly. If the switch is set to *Off*, the firing sequence is fixed starting with the lowest stage to the highest stage.

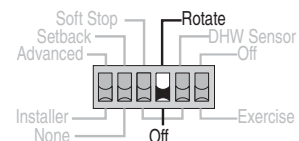

DHW Sensor / Off

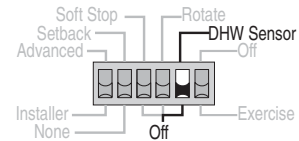

The *DHW Sensor / Off* DIP switch selects whether or not the control is to use an external or an internal DHW demand. If the DIP switch is set to *DHW Sensor*, the control generates an internal DHW demand by monitoring the DHW tank temperature. If the switch is set to *Off*, an aquastat would be used to generate the external DHW demand.



Off / Exercise

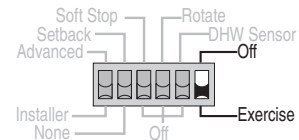

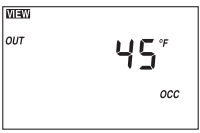
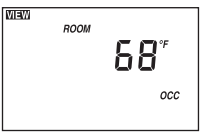
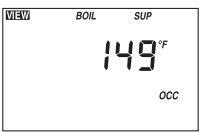
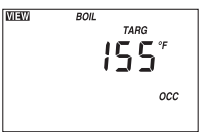

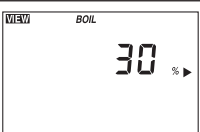
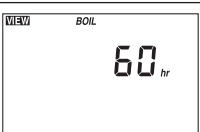
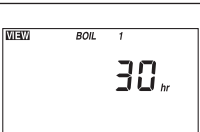
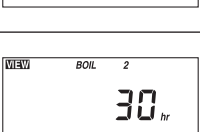

The *Off / Exercise* DIP switch selects whether or not the control is to exercise the primary pump and boiler pumps. If the DIP switch is set to *Exercise*, the pumps are operated for 10 seconds after every three days of inactivity.



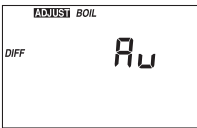
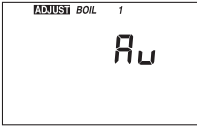
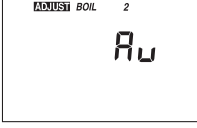
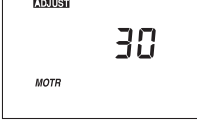
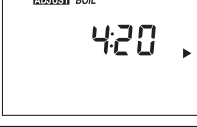
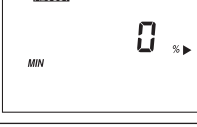

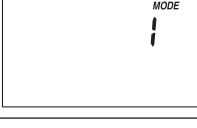



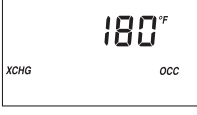

Display	Section Installer Advanced	Description	Range
	● ●	Outdoor Current outdoor air temperature as measured by the outdoor sensor.	-76 to 149°F (-60 to 65°C)
	● ●	Room Occupied Current room air temperature as measured by the indoor sensor. This item is only available when an indoor sensor is connected to the control.	23 to 113°F (-5 to 45°C)
	● ●	Boiler Supply Current boiler supply water temperature as measured by the boiler supply sensor.	-22 to 266°F (-30 to 130°C)
	●	Boiler Target Boiler target temperature is the temperature the control is currently trying to maintain at the boiler supply sensor +/- 1/2 of the differential.	---, 35 to 230°F (---, 2 to 110°C)
	● ●	DHW Current DHW tank temperature as measured by the DHW sensor. A DHW sensor must be installed to view this item.	---, 35 to 230°F (---, 2 to 110°C)
	B3 ●	Boiler Modulation Current percent modulation of the boiler's burner. This item is only available in operating mode 2.	0 to 100%
	●	Boiler Hours The total running time of the boiler since this item was last cleared. To clear this item, press the ▲ and ▼ button simultaneously while viewing this item. This item is only available in operating mode 2.	0 to 1999 hr
	●	Boiler 1 Hours The total running time of boiler 1 since this item was last cleared. To clear this item, press the ▲ and ▼ button simultaneously while viewing this item. This item is only available in operating mode 1 and boiler 1 is set to Au (automatic).	0 to 1999 hr
	●	Boiler 2 Hours The total running time of boiler 2 since this item was last cleared. To clear this item, press the ▲ and ▼ button simultaneously while viewing this item. This item is only available in operating mode 1 and boiler 2 is set to Au (automatic).	0 to 1999 hr

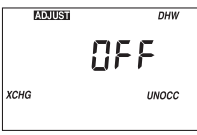
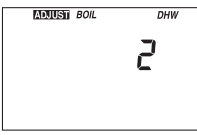
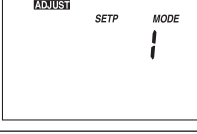
Adjust Menu (1 of 3)

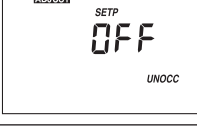
Display	Section Installer Advanced	Description	Range	Actual Setting
	A ●	Mode Selects the control mode of operation.	1 (2 on / off) 2 (1 mod & pump) Default = 1	
	●	Room Occupied The desired room air temperature during the occupied period.	35 to 100°F (2 to 38°C) Default = 70°F (21°C)	
	D1 ●	Room Unoccupied The desired room air temperature during the unoccupied period. This item is only available when the <i>Setback / None</i> DIP switch is set to <i>Setback</i> .	35 to 100°F (2 to 38°C, OFF) Default = 65°F (18°C)	
	D1 ●	Outdoor Design The design outdoor air temperature used in the heat loss calculations for the heating system.	-60 to 45°F (-51 to 7°C) Default = 10°F (-12°C)	
	D1 ●	Terminal Unit The type of terminal units that are being used in the heating system.	1 (HRF1), 2 (HRF2), 3 (COIL), 4 (CONV), 5 (RAD), 6 (BASE) Default = 4	
	D1 ●	Boiler Indoor The design indoor air temperature used in the heat loss calculation for the heating system.	35 to 100°F (2 to 38°C) Default = 70°F (21°C)	
	D1 ●	Boiler Design The design supply water temperature used in the heat loss calculations for the heating system.	70 to 220°F (21 to 104°C) Default = 180°F (82°C)	
	B1 ●	Boiler Minimum The minimum allowed boiler target temperature. Check the boiler(s) manufacturer's manual for recommend return water temperatures.	OFF, 80 to 180°F (OFF, 27 to 82°C) Default = 140°F (60°C)	
	B1 ●	Boiler Maximum The maximum allowed boiler target temperature.	120 to 225°F, OFF (49 to 107°C, OFF) Default = 200°F (93°C)	
	B1 ●	Fire Delay The time delay the control can expect between the time that the relay contact closes to fire the boiler and when the burner actually fires.	0:00 to 4:00 minutes (1 sec increment) Default = 0:10 minutes	
	B2 ● B3 ●	Boiler Mass The thermal mass characteristics of the boilers that are being used.	1 (Lo) 2 (Med) 3 (Hi) Default = 2 (Med)	
	B2 ●	Stage Delay The minimum time delay between the operation of stages. This item is only available in operating mode 1.	Au, 0:30 to 19:55 minutes Default = Au	

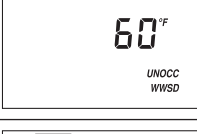
Display	Section Installer Advanced	Description	Range	Actual Setting
	B2 B3	● Boiler Differential The temperature differential that the control is to use when it is operating the boiler(s).	Au, 2 to 42°F (Au, 1 to 23°C) Default = Au	
	●	● Boiler 1 Selects whether or not boiler 1 is operational. This item is only available in operating mode 1.	Au (automatic), OFF Default = Au	
	●	● Boiler 2 Selects whether or not boiler 2 is operational. This item is only available in operating mode 1.	Au (automatic), OFF Default = Au	
	B3	● Motor Speed The amount of time required for the modulating actuating motor to fully open the gas valve or operate the fan speed from a stopped position to full speed. This item is only available in operating mode 2.	10 to 230 seconds Default = 30	
	B3	● Boiler Modulation Selects either a 4 to 20 mA or a 0 to 20 mA output signal. This item is only available in operating mode 2.	4:20 to 0:20 Default = 4:20	
	B3	● Minimum Modulation The minimum percent modulation of the burner. This item is only available in operating mode 2.	0 to 50% Default = 0%	
	B3	● Maximum Modulation The maximum percent modulation of the burner. This item is only available in operating mode 2.	50 to 100% Default = 100%	
	E1 E2	● DHW Mode Selects the DHW mode of operation.	1 (parallel, no priority), 2 (parallel, priority), 3 (pri-sec, no priority), 4 (pri-sec, priority) Default = 1	
	●	● DHW Occupied The target DHW tank temperature during the Occupied period. This item is only available when the <i>DHW Sensor / Off</i> DIP switch is set to <i>DHW Sensor</i> .	OFF, 70 to 190°F (OFF, 21 to 88°C) Default = 140°F (60°C)	
	●	● DHW Unoccupied The target DHW tank temperature during the Unoccupied period. This item is only available when the <i>DHW Sensor / Off</i> DIP switch is set to <i>DHW Sensor</i> and the <i>Setback / None</i> DIP switch is set to <i>Setback</i> .	OFF, 70 to 190°F (OFF, 21 to 88°C) Default = OFF	
	●	● DHW Differential Sets the DHW differential temperature for the DHW tank temperature. This item is only available when the <i>DHW Sensor / Off</i> DIP switch is set to <i>DHW Sensor</i> .	1 to 42°F (1 to 23°C) Default = 6°F (3°C)	
	●	● DHW Exchange Occupied The minimum boiler supply temperature to the DHW heat exchanger during the Occupied period. This item is only available when the <i>DHW Sensor / Off</i> DIP switch is set to <i>Off</i> .	OFF, 100 to 220°F (OFF, 38 to 104°C) Default = 180°F (82°C)	

Adjust Menu (3 of 3)

Display	Section Installer Advanced	Description	Range	Actual Setting
		<ul style="list-style-type: none"> ● DHW Exchange Unoccupied Selects whether or not a DHW demand will be responded to during the UnOccupied period. This item is only available when the <i>DHW Sensor / Off</i> DIP switch is set to <i>Off</i> and the <i>Setback / None</i> DIP switch is set to <i>Setback</i>. 	OFF, On Default = OFF	
		<ul style="list-style-type: none"> ● DHW Boilers Selects how many boilers are to be operated during DHW generation. This item is only available in operating mode 1. 	1, 2 Default = 2	
	F1	<ul style="list-style-type: none"> ● Setpoint Mode Selects the Setpoint mode of operation. 	1 (parallel, no priority), 2 (parallel, priority), 3 (primary pump) Default = 1	
		<ul style="list-style-type: none"> ● Setpoint Occupied The minimum supply temperature when a setpoint demand is present during the Occupied period. 	OFF, 60 to 220°F (OFF, 16 to 104°C) Default = 180°F (82°C)	
		<ul style="list-style-type: none"> ● Setpoint Unoccupied Selects whether or not a setpoint demand will be responded to during the Unoccupied period. This item is only available when the <i>Setback / None</i> DIP switch is set to <i>Setback</i>. 	OFF, On Default = OFF	
		<ul style="list-style-type: none"> ● WWSO Occupied The system's warm weather shut down temperature during the Occupied period. 	35 to 100°F, OFF (2 to 38°C, OFF) Default = 70°F (21°C)	
		<ul style="list-style-type: none"> ● WWSO Unoccupied The system's warm weather shut down temperature during the Unoccupied period. This item is only available when the <i>Setback / None</i> DIP switch is set to <i>Setback</i>. 	35 to 100°F, OFF (2 to 38°C, OFF) Default = 60°F (16°C)	
	D1	<ul style="list-style-type: none"> ● Boost The amount of morning boost. This item is only available when the <i>Setback / None</i> DIP switch is set to <i>Setback</i>. 	OFF, 0:20 to 8:00 hr (5 min increments) Default = OFF	
	C1	<ul style="list-style-type: none"> ● Primary Pump Purge The maximum length of time that the primary pump will continue to operate after the boiler demand has been removed. 	OFF, 0:10 to 19:55 minutes (5 second increments) Default = 0:20 min	
	C1	<ul style="list-style-type: none"> ● Boiler Pump Purge The length of time that the boiler pump will continue to run after the last stage in the boiler has turned off. This item is only available in operating MODE 2. 	OFF, 0:10 to 19:55 minutes (5 second increments) Default = 0:20 min	
		<ul style="list-style-type: none"> ● The units of measure that all of the temperatures are to be displayed in by the control. 	°F, °C Default = °F	

Time Menu (1 of 1)

Note: The *Setback / Off* DIP switch must be in the *Setback* position in order to have access to the TIME menu.

SETTING THE TIME



Step One

Press and release the **Menu** button until the TIME menu is reached.



Step Two

Press the **Item** button. While the minutes are flashing, use the ▲ or ▼ button to set the proper minutes.



Step Three

Press and release the **Item** button. While the hours are flashing, use the ▲ or ▼ button to set the proper hour.



Step Four

Press and release the **Item** button. While the day is flashing, use the ▲ or ▼ button to set the proper day.

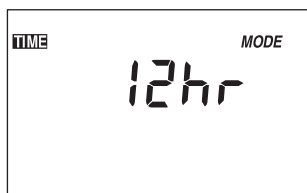

Step Five (Only available in advanced access level.)

Press and release the **Item** button. Use the ▲ or ▼ button to select between 12 and 24 hour time.

Schedule Menu (1 of 1)

Note: The *Setback / Off DIP* switch must be in the setback position in order to have access to the SCHEDULE menu.

SETTING THE SCHEDULE

A schedule allows the timer to automatically change between two preset events based on the time of day. The schedule divides the day into Occupied and UnOccupied periods. To set the time of day at which each period is to begin, use the following procedure.

Step One

Press and release the **Menu** button until the SCHED (Schedule) menu is displayed

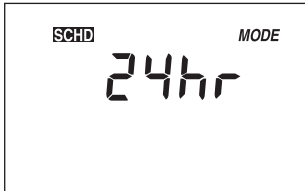

Step Two (Only available in advanced access level.)

Use the ▲ or ▼ button to select a 24 hour, 5-1-1 day, or a 7 day schedule.

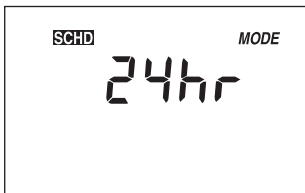

or

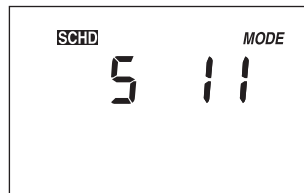

or

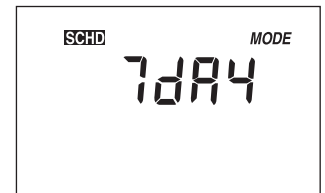

Step Three

Press and release the **Item** button. Use the ▲ or ▼ button to set the event's beginning time. If the event is not required, select the "--:--" time. This time is found between 11:50 PM and 12:00 AM. Record the event time in the schedule table found at the bottom of this page for future reference. Press the **Item** button to advance to the next setting.

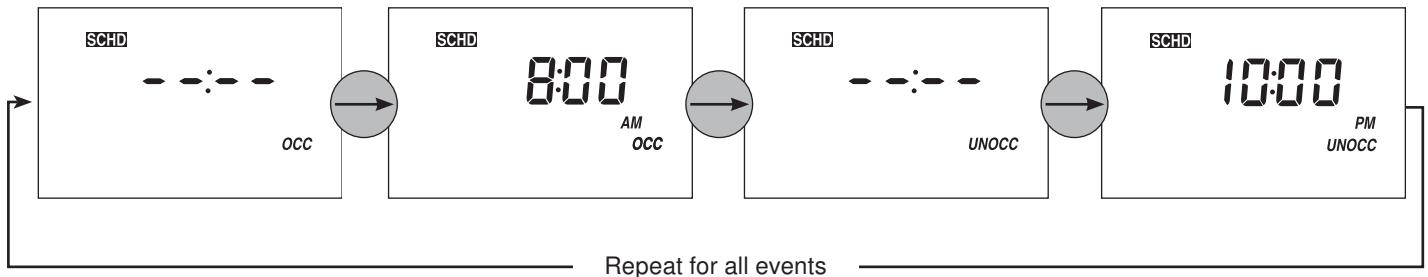

TWO EVENT SCHEDULE

Event	24 hr Schedule	Sat	Sun	Mon	Tue	Wed	Thu	Fri
Occ								
UnOcc								

Testing the Control

The control has a built-in test routine that is used to test the main control functions. The control continually monitors the sensors and displays an error message whenever a fault is found. See the following pages for a list of the control's error messages and possible causes. When the **Test** button is pressed, the *Test* light is turned on. The individual outputs and relays are tested in the following test sequence.

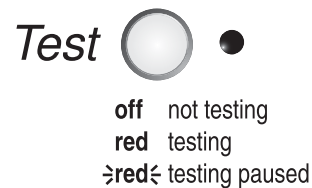

TEST SEQUENCE

Each step in the test sequence lasts 10 seconds.

During the test routine, if a demand from the system is present, the test sequence may be paused by pressing the **Test** button. If the **Test** button is not pressed again for 5 minutes while the test sequence is paused, the control exits the entire test routine. If the test sequence is paused, the **Test** button can be pressed again to advance to the next step. This can also be used to rapidly advance through the test sequence. To reach the desired step, repeatedly press and release the **Test** button until the appropriate device and segment in the display turn on.

Test sequence when in MODE 1 - Two Stage On / Off Stages:

- Step 1 – The primary pump contact is closed.
- Step 2 – If Boiler 1 is set to automatic (Au), the Boiler 1 contact is closed for the Fire Delay time or a minimum of 10 seconds.
- Step 3 – If Boiler 2 is set to automatic (Au), the Boiler 2 contact is closed for the Fire Delay time or a minimum of 10 seconds.
- Step 4 – Boiler 1 and Boiler 2 contacts are opened.
 - If DHW MODE is set to 1 or 2, the DHW Pmp / Vlv contact is closed and the primary pump contact is opened.
 - If DHW MODE is set to 3 or 4, the DHW Pmp / Vlv contact is closed and the primary pump contact remains closed.
- Step 5 – After the test sequence is completed, the control resumes its normal operation.

Test sequence when in MODE 2 - One Modulating Boiler and Pump:

- Step 1 – The primary pump contact is closed.
- Step 2 – The boiler pump contact is closed.
- Step 3 – The Boiler 1 contact is closed and the modulation output is set to the Minimum Modulation setting.
- Step 4 – If there is a demand present, the modulation output increases to Maximum Modulation according to the Motor Speed setting.
- Step 5 – If there is a demand present, the modulation output decreases to Minimum Modulation according to the Motor Speed setting.
- Step 6 – The Boiler 1 and boiler pump contacts are opened.
 - If DHW MODE is set to 1 or 2, the DHW Pmp / Vlv contact is closed and the primary pump contact is opened.
 - If DHW MODE is set to 3 or 4, the DHW Pmp / Vlv contact is closed and the primary pump contact remains closed.
- Step 7 – After the test sequence is completed, the control resumes its normal operation.

MAX HEAT

The control has a function called Max Heat. In this mode, the control turns on and operates the system up to the maximum set temperatures as long as there is a demand for heat. The control continues to operate in this mode for up to 24 hours or until the **Item**, **Menu** or **Test** button is pressed. This mode may be used for running all circulators during system start-up in order to purge air from the piping. To enable the Max Heat feature, use the following procedure.

- 1) Press and hold the **Test** button for more than 3 seconds. At this point, the control flashes the MAX segment and displays the word OFF
- 2) Using the ▲ or ▼ buttons, select the word On. After 3 seconds, the control turns on all outputs. However, the max heat mode is still limited by the **BOIL MAX** setting.
- 3) To cancel the Max Heat mode, press the **Item**, **Menu**, or **Test** button.
- 4) Once the Max Heat mode has either ended or is cancelled, the control resumes normal operation.



Error Messages (1 of 2)

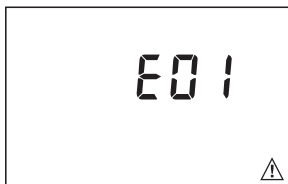

The control was unable to read a piece of information stored in its memory. Because of this, the control was required to reload the factory settings into all of the items in the ADJUST menu. The control will stop operation until all of the items in the ADJUST menu of the control have been checked by the user or installer.

Note: The *Advanced / Installer* DIP switch must be set to *Advanced* in order to clear the error.

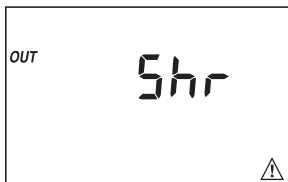

The control is no longer able to read the outdoor sensor due to a short circuit. In this case the control assumes an outdoor temperature of 32°F (0°C) and continues operation. Locate and repair the problem as described in the Data Brochure D 070. To clear the error message from the control after the sensor has been repaired, press either the **Menu** or **Item** button.

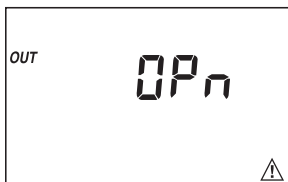

The control is no longer able to read the outdoor sensor due to an open circuit. In this case the control assumes an outdoor temperature of 32°F (0°C) and continues operation. Locate and repair the problem as described in the Data Brochure D 070. To clear the error message from the control after the sensor has been repaired, press either the **Menu** or **Item** button.

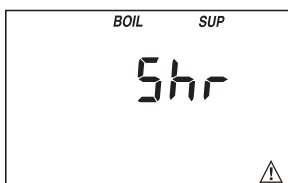

The control is no longer able to read the boiler supply sensor due to a short circuit. The control will not operate the boiler(s) until the sensor is repaired. Locate and repair the problem as described in the Data Brochure D 070. To clear the error message from the control after the sensor has been repaired, press either the **Menu** or **Item** button.

Error Messages (2 of 2)

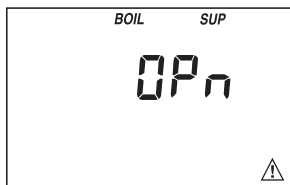

The control is no longer able to read the boiler supply sensor due to an open circuit. The control will not operate the boiler(s) until the sensor is repaired. Locate and repair the problem as described in the Data Brochure D 070. To clear the error message from the control after the sensor has been repaired, press either the **Menu** or **Item** button.

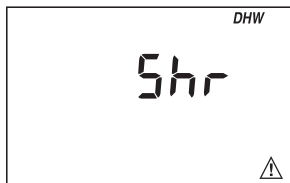

The control is no longer able to read the DHW sensor due to a short circuit. The control will not operate the DHW contact until the sensor is repaired. Locate and repair the problem as described in the Data Brochure D 070. To clear the error message from the control after the sensor has been repaired, press either the **Menu** or **Item** button.

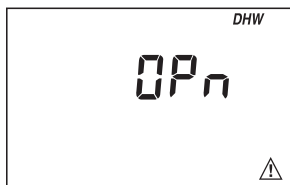

The control is no longer able to read the DHW sensor due to an open circuit. The control will not operate the DHW contact until the sensor is repaired. Locate and repair the problem as described in the Data Brochure D 070. To clear the error message from the control after the sensor has been repaired, press either the **Menu** or **Item** button.

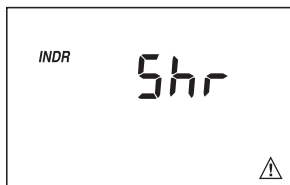

The control is no longer able to read the indoor sensor due to a short circuit. The control will operate the system as if an indoor sensor were not installed until the indoor sensor is repaired. Locate and repair the problem as described in the Data Brochure D 076. To clear the error message from the control after the sensor has been repaired, press either the **Menu** or **Item** button.

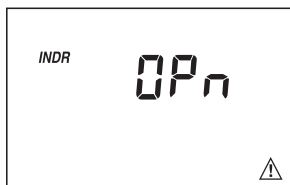

The control is no longer able to read the indoor sensor due to an open circuit. The control will operate the system as if an indoor sensor were not installed until the indoor sensor is repaired. Locate and repair the problem as described in the Data Brochure D 076. To clear the error message from the control after the sensor has been repaired, press either the **Menu** or **Item** button.

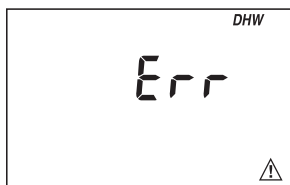

The control has received both an external and an internal DHW demand at the same time. The control will respond to the internal DHW demand and will ignore the external demand. Check the DHW demand terminals to determine if there is an external DHW demand. To clear the error message from the control, press either the **Menu** or **Item** button.

Technical Data

Boiler Control 263 Two Stage / One Modulating, DHW & Setpoint

Literature	— D 263, A 263's, D 001, D 070.
Control	— Microprocessor PID control; This is not a safety (limit) control .
Packaged weight	— 3.3 lb. (1500 g), Enclosure A, blue modified PVC plastic
Dimensions	— 6-5/8" H x 7-9/16" W x 2-13/16" D (170 x 193 x 72 mm)
Approvals	— CSA C US, CSA/UL 61010-1, meets Class B: ICES & FCC Part 15
Ambient conditions	— Indoor use only, 32 to 122°F (0 to 50°C), < 90% RH non-condensing. Altitude <6560 feet (2000 m)
Power supply	— 115 V (ac) ±10% 50/60 Hz 600 VA
Relay capacity	— 230 V (ac) 5 A 1/3 hp pilot duty 240 VA
Modulation Output Demands	— 0-20 mA / 4-20 mA (up to 1000 Ω load)
Sensors included	— NTC thermistor, 10 kΩ @ 77°F (25°C ±0.2°C) β=3892
Optional devices	— Outdoor Sensor 070 and Universal Sensor 082, 500 Ω Resistor Indoor Sensor 076/077, Universal Sensor 078

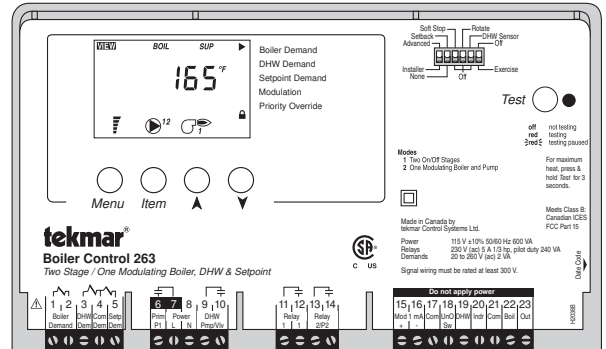

The installer must ensure that this control and its wiring are isolated and/or shielded from strong sources of electromagnetic noise. Conversely, this Class B digital apparatus complies with Part 15 of the FCC Rules and meets all requirements of the Canadian Interference-Causing Equipment Regulations. However, if this control does cause harmful interference to radio or television reception, which is determined by turning the control off and on, the user is encouraged to try to correct the interference by re-orientating or relocating the receiving antenna, relocating the receiver with respect to this control, and/or connecting the control to a different circuit from that to which the receiver is connected.

Cet appareil numérique de la classe B respecte toutes les exigences du Règlement sur le matériel brouilleur du Canada.

Caution The nonmetallic enclosure does not provide grounding between conduit connections. Use grounding type bushings and jumper wires.

Attention Un boîtier non métallique n'assure pas la continuité électrique des conduits. Utiliser des manchons ou des fils de accord spécialement conçus pour la mise à la terre.

Limited Warranty and Product Return Procedure

Limited Warranty *The liability of tekmar under this warranty is limited. The Purchaser, by taking receipt of any tekmar product ("Product"), acknowledges the terms of the Limited Warranty in effect at the time of such Product sale and acknowledges that it has read and understands same.*

The tekmar Limited Warranty to the Purchaser on the Products sold hereunder is a manufacturer's pass-through warranty which the Purchaser is authorized to pass through to its customers. Under the Limited Warranty, each tekmar Product is warranted against defects in workmanship and materials if the Product is installed and used in compliance with tekmar's instructions, ordinary wear and tear excepted. The pass-through warranty period is for a period of twenty-four (24) months from the production date if the Product is not installed during that period, or twelve (12) months from the documented date of installation if installed within twenty-four (24) months from the production date.

The liability of tekmar under the Limited Warranty shall be limited to, at tekmar's sole discretion: the cost of parts and labor provided by tekmar to repair defects in materials and/or workmanship of the defective product; or to the exchange of the defective product for a warranty replacement product; or to the granting of credit limited to the original cost of the defective product, and such repair, exchange or credit shall be the sole remedy available from tekmar, and, without limiting the foregoing in any way, tekmar is not responsible, in contract, tort or strict product liability, for any other losses, costs, expenses, inconveniences, or damages, whether direct, indirect, special, secondary, incidental or consequential, arising from ownership or use of the product, or from defects in workmanship or materials, including any liability for fundamental breach of contract.

The pass-through Limited Warranty applies only to those defective Products returned to tekmar during the warranty period. This Limited Warranty does not cover the cost of the parts or labor to remove or transport the defective Product, or to reinstall the repaired or replacement Product, all such costs and expenses being subject to Purchaser's agreement and warranty with its customers.

Any representations or warranties about the Products made by Purchaser to its customers which are different from or in excess of the tekmar Limited Warranty are

the Purchaser's sole responsibility and obligation. Purchaser shall indemnify and hold tekmar harmless from and against any and all claims, liabilities and damages of any kind or nature which arise out of or are related to any such representations or warranties by Purchaser to its customers.

The pass-through Limited Warranty does not apply if the returned Product has been damaged by negligence by persons other than tekmar, accident, fire, Act of God, abuse or misuse; or has been damaged by modifications, alterations or attachments made subsequent to purchase which have not been authorized by tekmar; or if the Product was not installed in compliance with tekmar's instructions and/or the local codes and ordinances; or if due to defective installation of the Product; or if the Product was not used in compliance with tekmar's instructions.

THIS WARRANTY IS IN LIEU OF ALL OTHER WARRANTIES, EXPRESS OR IMPLIED, WHICH THE GOVERNING LAW ALLOWS PARTIES TO CONTRACTUALLY EXCLUDE, INCLUDING, WITHOUT LIMITATION, IMPLIED WARRANTIES OF MERCHANTABILITY AND FITNESS FOR A PARTICULAR PURPOSE, DURABILITY OR DESCRIPTION OF THE PRODUCT, ITS NON-INFRINGEMENT OF ANY RELEVANT PATENTS OR TRADEMARKS, AND ITS COMPLIANCE WITH OR NON-VIOLATION OF ANY APPLICABLE ENVIRONMENTAL, HEALTH OR SAFETY LEGISLATION; THE TERM OF ANY OTHER WARRANTY NOT HEREBY CONTRACTUALLY EXCLUDED IS LIMITED SUCH THAT IT SHALL NOT EXTEND BEYOND TWENTY-FOUR (24) MONTHS FROM THE PRODUCTION DATE, TO THE EXTENT THAT SUCH LIMITATION IS ALLOWED BY THE GOVERNING LAW.

Product Warranty Return Procedure All Products that are believed to have defects in workmanship or materials must be returned, together with a written description of the defect, to the tekmar Representative assigned to the territory in which such Product is located. If tekmar receives an inquiry from someone other than a tekmar Representative, including an inquiry from Purchaser (if not a tekmar Representative) or Purchaser's customers, regarding a potential warranty claim, tekmar's sole obligation shall be to provide the address and other contact information regarding the appropriate Representative.

tekmar[®]
Control Systems

tekmar Control Systems Ltd., Canada
tekmar Control Systems, Inc., U.S.A.
**Head Office: 5100 Silver Star Road
Vernon, B.C. Canada V1B 3K4
(250) 545-7749 Fax. (250) 545-0650
Web Site: www.tekmarcontrols.com**

