

Features of the Boiler Control 264

Please refer to Essay E 005: Control Functions and Benefits for a detailed description of these features.

- Outdoor Reset
- Characterized Heating Curve
- Water Temperature Setback
- Boost
- Warm Weather Shut Down
- Boiler Outdoor Reset
- Boiler Differential (Automatic)
- Boiler Minimum Supply
- Boiler Post Purge
- DHW Boiler Reset Override
- DHW Condensing Boiler
- DHW External Demand
- DHW Post Purge
- DHW Priority
- DHW Setback
- PID Staging
- Equal Run Time Rotation
- Lo / Hi Fire Boiler Rotation
- Fixed Lead
- Fixed Last
- Fire Delay
- Boiler Mass
- Setpoint Boiler Reset Override
- Setpoint Priority

Application

The tekmar Boiler Control 264 can control the supply water temperature from up to 4 on / off stages based on outdoor temperature, control for Domestic Hot Water (DHW) generation, or a setpoint requirement. A large easy to read display provides current system temperatures and operating status. The control has outputs for a primary pump and either a combustion air damper or alarm. Based on the mode of operation selected, the control can operate different combinations of boiler stages and boiler pumps.

- A1 = Alarm
- D1 = External Boiler Demand
- P1 = Primary System Pump
- S1 = Boiler Supply Sensor 071
- S2 = Boiler Return Sensor 071
- S3 = Outdoor Sensor 070

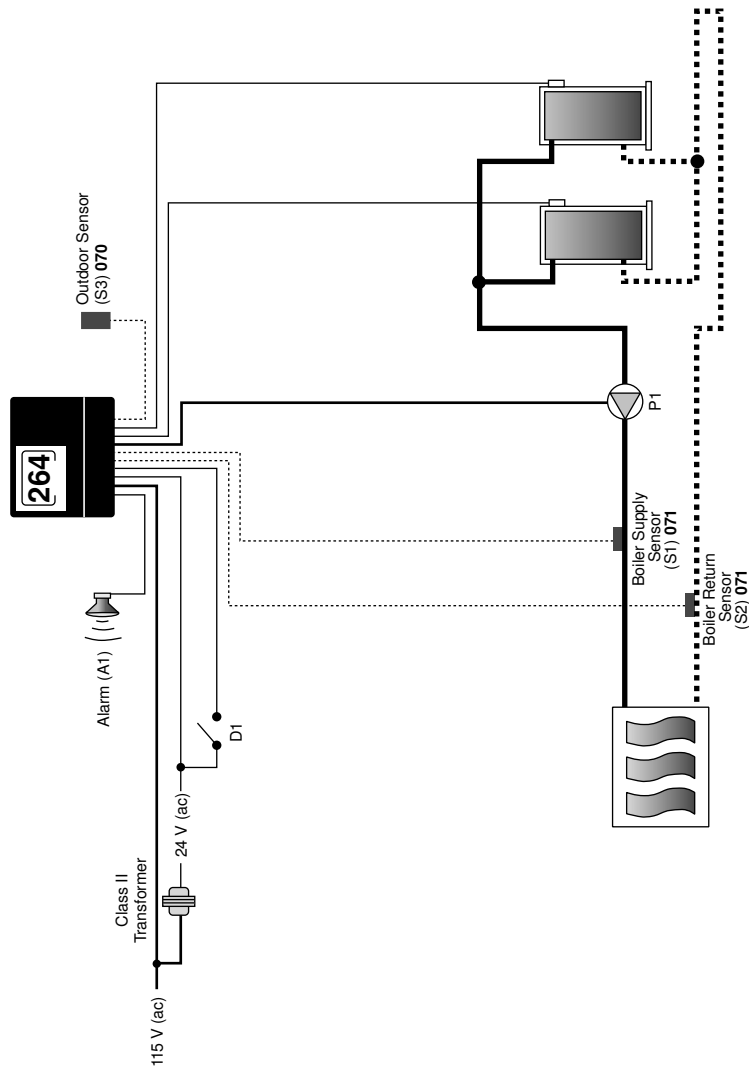

Concept Drawing

This is only a concept drawing, not an engineered drawing. It is not intended to describe a complete system, nor any particular system. It is up to the system designer to determine the necessary components for and configuration of the particular system being designed, including additional equipment, isolation relays (for loads greater than the control's specified output ratings), and any safety devices which in the judgement of the designer are appropriate, in order to properly size, configure and design that system and to ensure compliance with building and safety code requirements.

System Operation

The Boiler Control 264 provides outdoor reset to a space heating system. The boilers are piped in reverse return. The 264 has an alarm contact that closes during an error message.

tekmar Control Systems Ltd., Canada; tekmar Control Systems, Inc., U.S.A.; www.tekmarcontrols.com
Head Office: 5100 Silver Star Road, Vernon, B.C. Canada, V1B 3K4; (250) 545-7749 Fax (250) 545-0650

- A1 = Alarm
- D1 = External Boiler Demand
- P1 = Primary System Pump
- S1 = Boiler Supply Sensor 071
- S2 = Boiler Return Sensor 071
- S3 = Outdoor Sensor 070

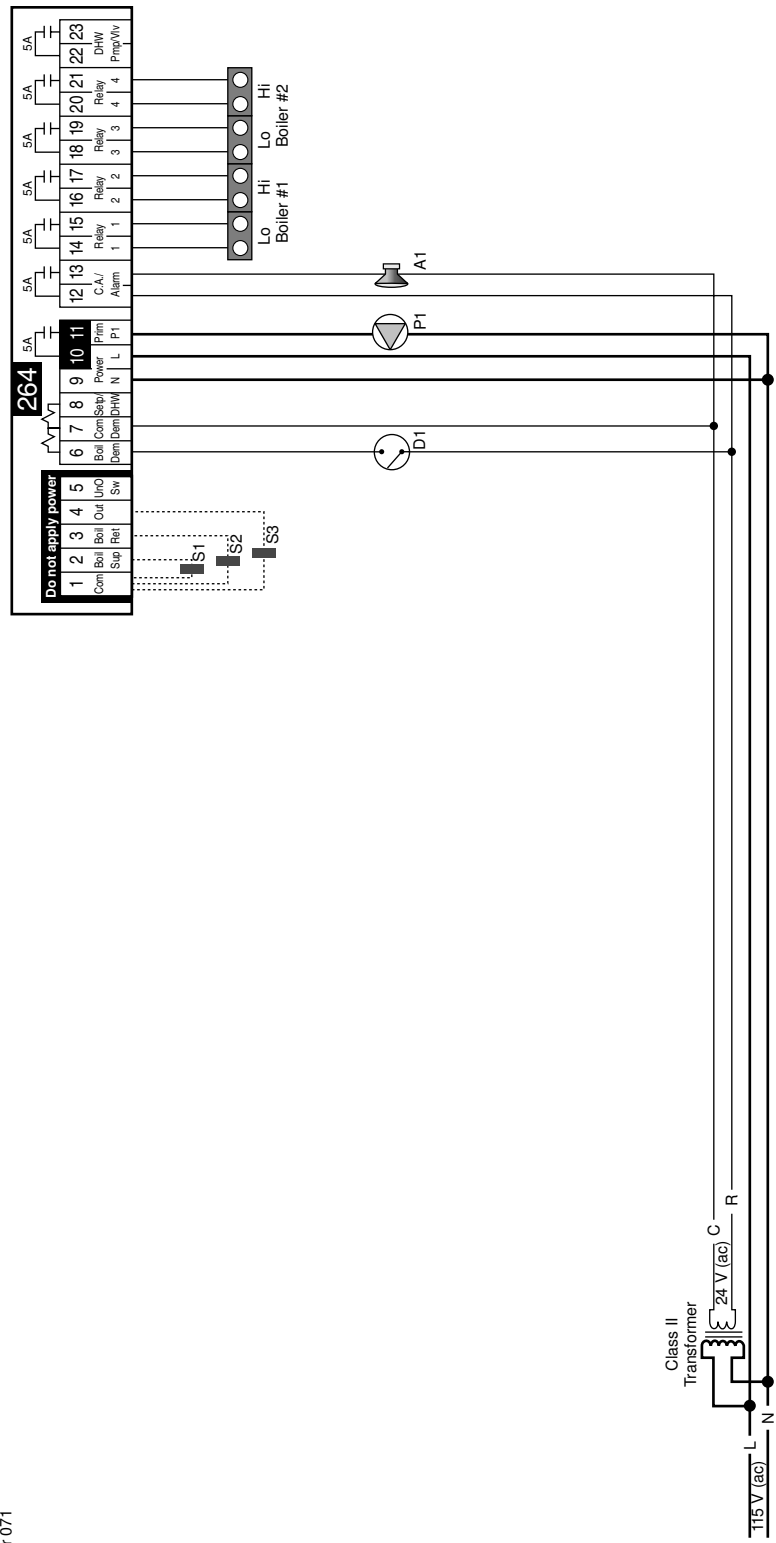

Concept Drawing
 This is only a concept drawing, not an engineered drawing. It is not intended to describe a complete system, nor any particular system. It is up to the system designer to determine the necessary components for and configuration of the particular system being designed, including additional equipment, isolation relays (for loads greater than the control's specified output ratings), and any safety devices which in the judgement of the designer are appropriate, in order to properly size, configure and design that system and to ensure compliance with building and safety code requirements.

Essential Control Settings
 MODE = 3

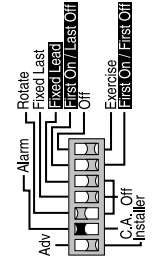

- required
- optional

tekmar Control Systems Ltd., Canada; tekmar Control Systems, Inc., U.S.A.; www.tekmarcontrols.com
Head Office: 5100 Silver Star Road, Vernon, B.C. Canada, V1B 3K4; (250) 545-7749 Fax (250) 545-0650

- A1 = DHW Aquastat
- C1 = Combustion Air Damper
- D1 = External Boiler Demand
- P1 = Primary System Pump
- P2, P3 = Boiler Pump
- P4 = DHW Pump
- S1 = Boiler Supply Sensor 071
- S2 = Boiler Return Sensor 071
- S3 = Outdoor Sensor 070

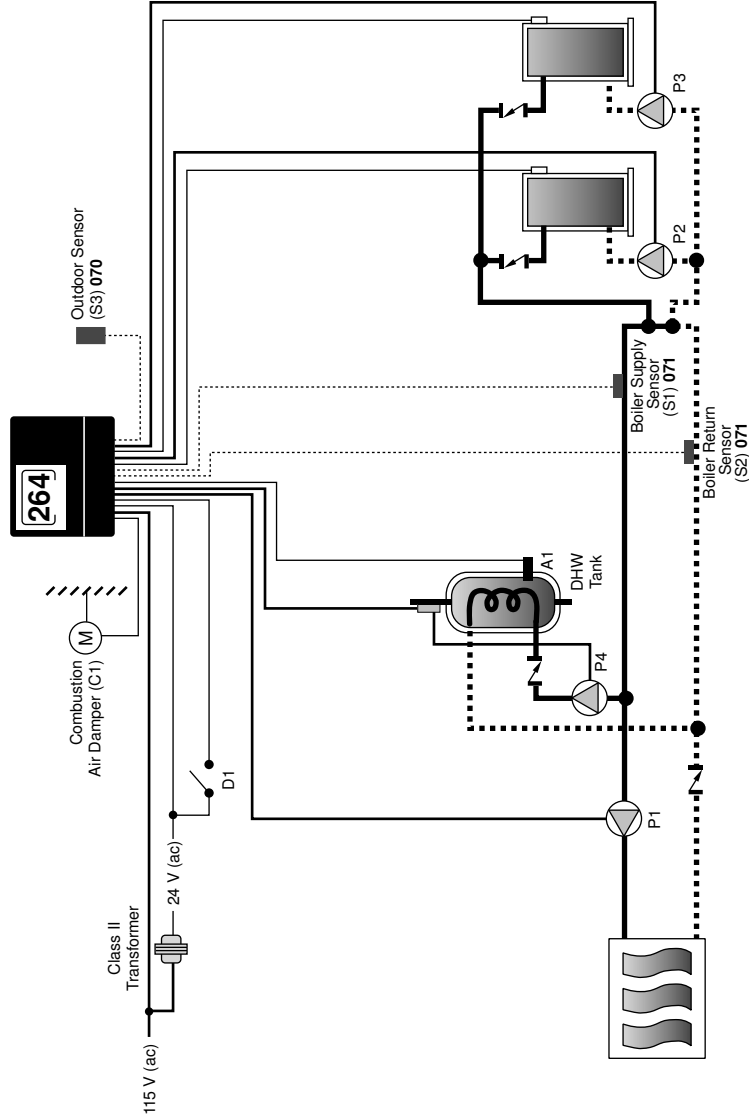

Concept Drawing

This is only a concept drawing, not an engineered drawing. It is not intended to describe a complete system, nor any particular system. It is up to the system designer to determine the necessary components for and configuration of the particular system being designed, including additional equipment, isolation relays (for loads greater than the control's specified output ratings), and any safety devices which in the judgement of the designer are appropriate, in order to properly size, configure and design that system and to ensure compliance with building and safety code requirements.

System Operation

The Boiler Control 264 provides outdoor reset to a space heating system and domestic hot water exchange temperature for an indirect domestic hot water tank. The 264 provides staging and rotation for two single stage boilers. The boilers are piped in parallel primary-secondary to the heating load. The individual boiler pumps are controlled by the 264 to allow for post purging of the boilers after they have shut off. The indirect domestic hot water tank is piped in parallel to the space heating load. The 264 opens a combustion air damper before the first boiler fires.

tekmar Control Systems Ltd., Canada; tekmar Control Systems, Inc., U.S.A.; www.tekmarcontrols.com
Head Office: 5100 Silver Star Road, Vernon, B.C. Canada, V1B 3K4; (250) 545-7749 Fax (250) 545-0650

- A1 = DHW Aquastat
- C1 = Combustion Air Damper
- D1 = External Boiler Demand
- P1 = Primary System Pump
- P2, P3 = Boiler Pump
- P4 = DHW Pump
- S1 = Boiler Supply Sensor 071
- S2 = Boiler Return Sensor 071
- S3 = Outdoor Sensor 070

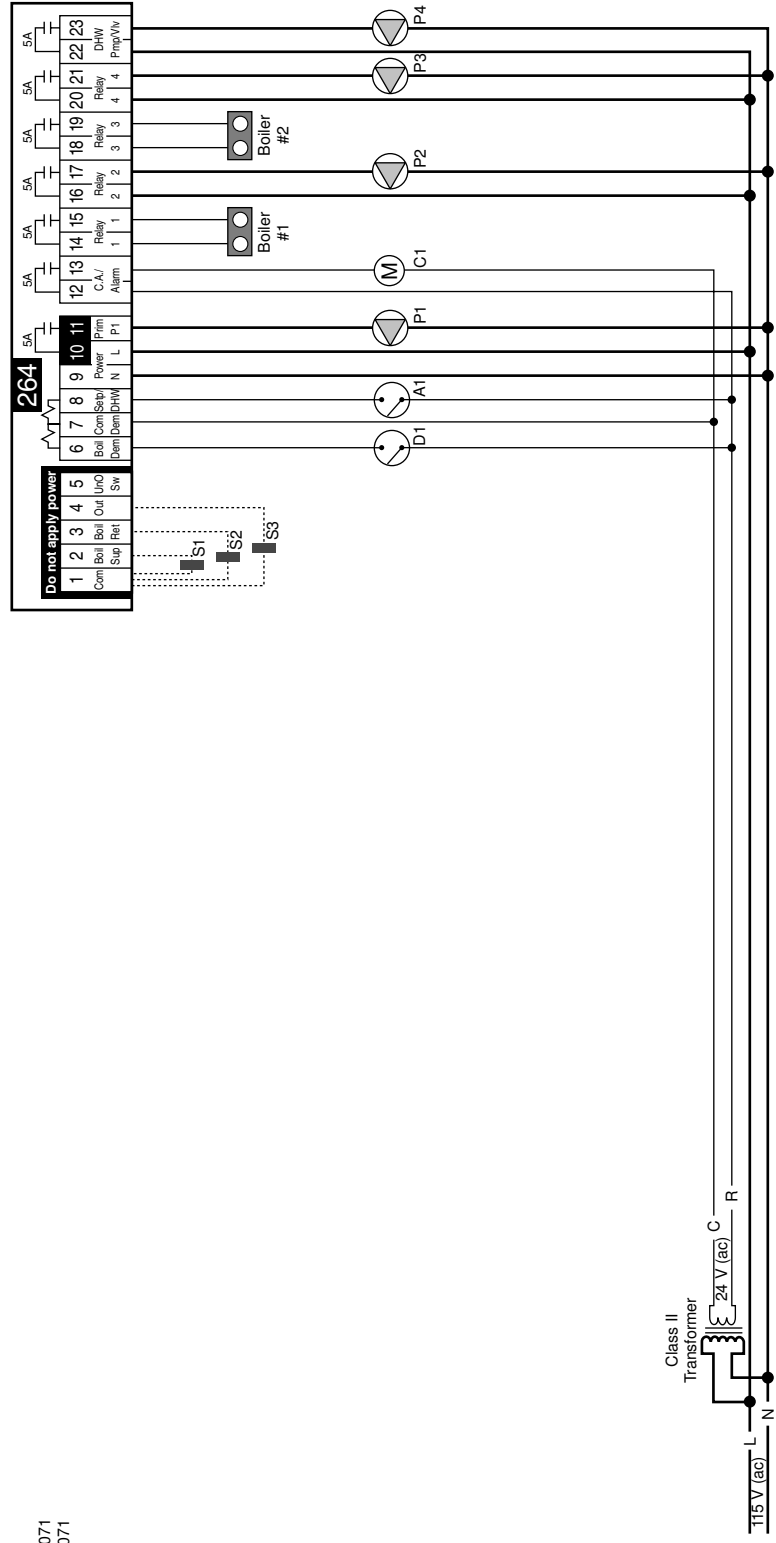

Concept Drawing
 This is only a concept drawing, not an engineered drawing. It is not intended to describe a complete system, nor any particular system. It is up to the system designer to determine the necessary components for and configuration of the particular system being designed, including additional equipment, isolation relays (for loads greater than the control's specified output ratings), and any safety devices which in the judgement of the designer are appropriate, in order to properly size, configure and design that system and to ensure compliance with building and safety code requirements.

Essential Control Settings
 MODE = 2
 DHW MODE = 1 (no priority)
 2 (priority)

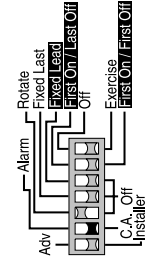

- required
- optional

tekmar Control Systems Ltd., Canada; tekmar Control Systems, Inc., U.S.A.; www.tekmarcontrols.com
Head Office: 5100 Silver Star Road, Vernon, B.C. Canada, V1B 3K4; (250) 545-7749 Fax (250) 545-0650

- C1 = Combustion Air Damper
- D1 = External Boiler Demand
- P1 = Primary System Pump
- P2, P3 = Boiler Pump
- R1 = Relay 003
- S1 = Boiler Supply Sensor 071
- S2 = Pool Sensor 071
- S3 = Outdoor Sensor 070
- V1 = Balancing or Globe Valve

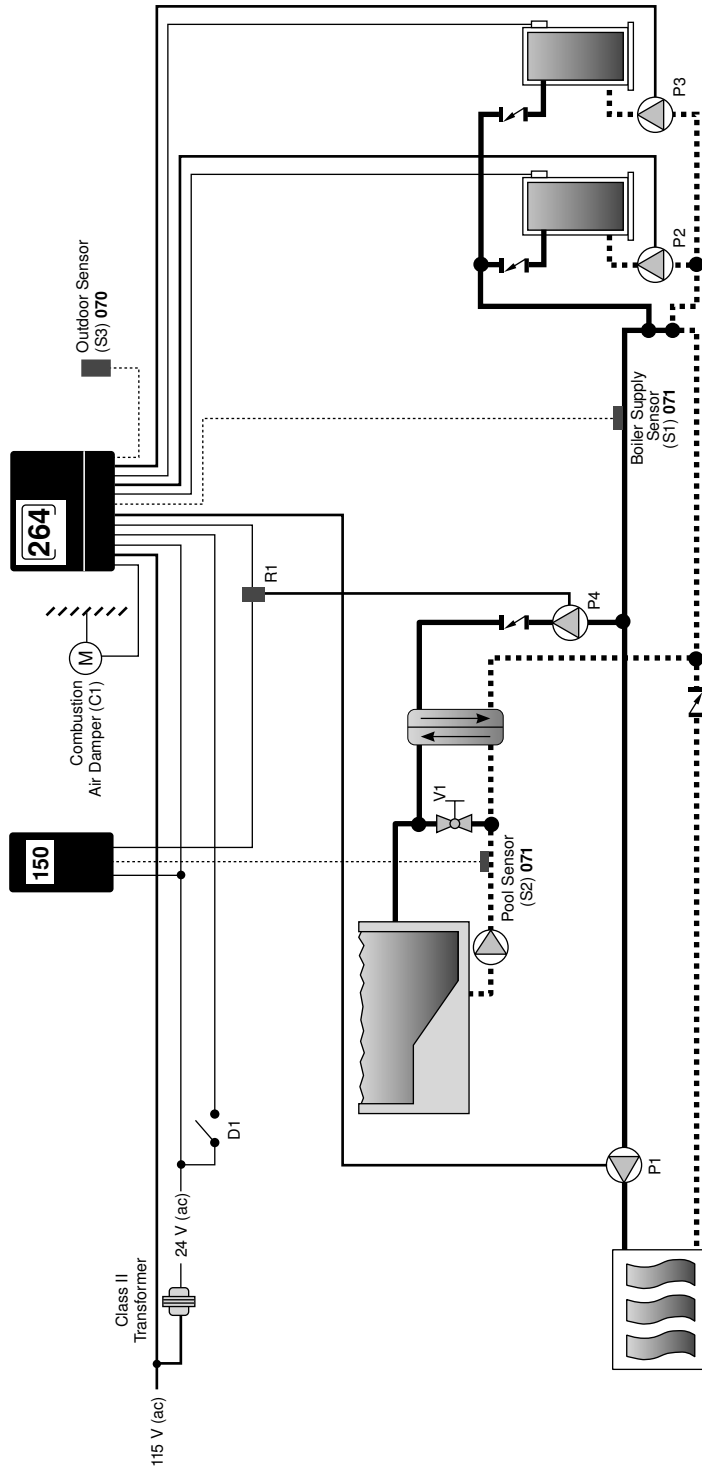

Concept Drawing

This is only a concept drawing, not an engineered drawing. It is not intended to describe a complete system, nor any particular system. It is up to the system designer to determine the necessary components for and configuration of the particular system being designed, including additional equipment, isolation relays (for loads greater than the control's specified output ratings), and any safety devices which in the judgement of the designer are appropriate, in order to properly size, configure and design that system and to ensure compliance with building and safety code requirements.

System Operation

The Boiler Control 264 provides outdoor reset to a space heating system and setpoint operation for a pool or similar load. The 264 provides staging and rotation for two single stage boilers. The boilers are piped parallel primary-secondary to the heating load and the individual boiler pumps are controlled by the 264 to allow post purging of the boilers after they have shut off. The setpoint load is piped in parallel with the space heating load. The 264 closes a contact to open a combustion air damper before the first boiler fires.

tekmar Control Systems Ltd., Canada; tekmar Control Systems, Inc., U.S.A.; www.tekmarcontrols.com
Head Office: 5100 Silver Star Road, Vernon, B.C. Canada, V1B 3K4; (250) 545-7749 Fax (250) 545-0650

- C1 = Combustion Air Damper
D1 = External Boiler Demand
P1 = Primary System Pump
P2, P3 = Boiler Pump
R1 = Relay 003
S1 = Boiler Supply Sensor 071
S2 = Pool Sensor 071
S3 = Outdoor Sensor 070

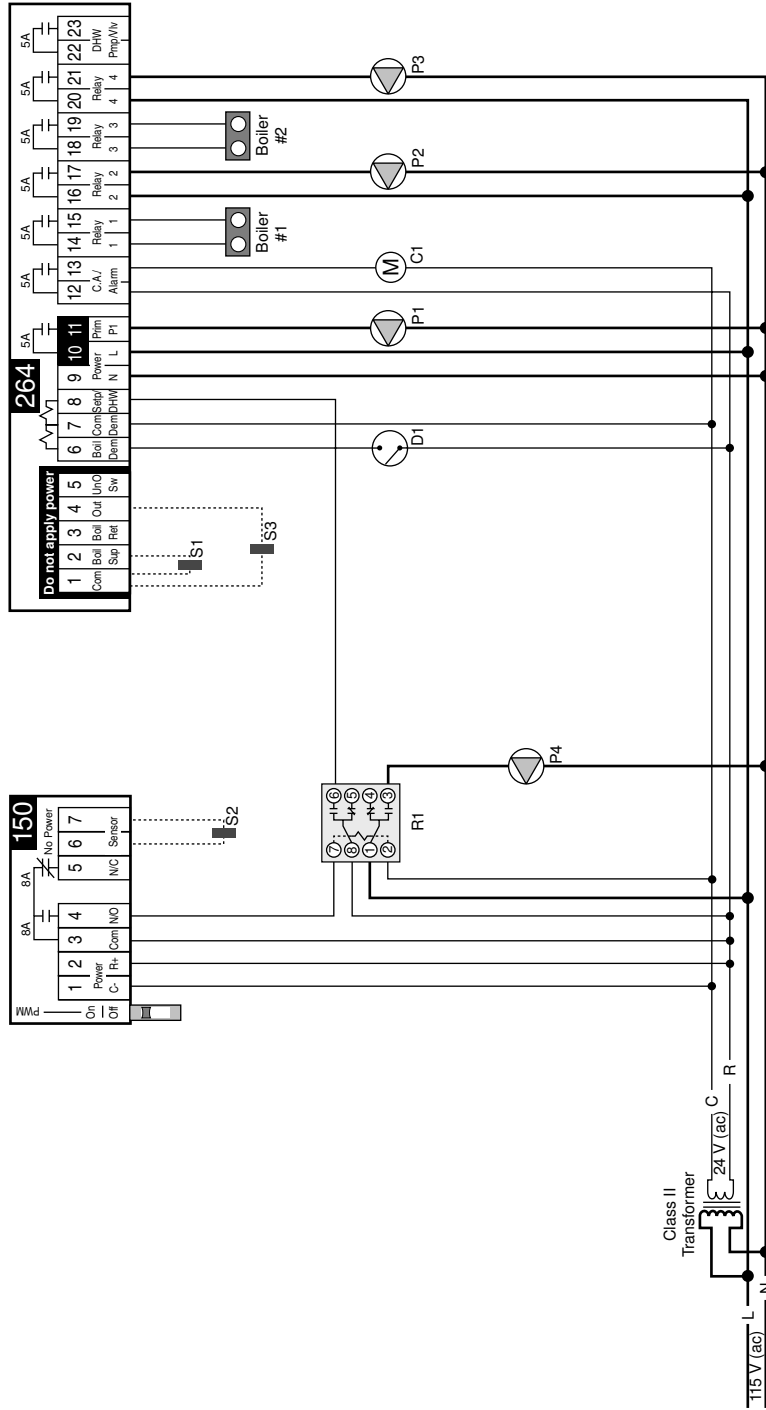

Concept Drawing

This is only a concept drawing, not an engineered drawing. It is not intended to describe a complete system, nor any particular system. It is up to the system designer to determine the necessary components for and configuration of the particular system being designed, including additional equipment, isolation relays (for loads greater than the control's specified output ratings), and any safety devices which in the judgement of the designer are appropriate, in order to properly size, configure and design that system and to ensure compliance with building and safety code requirements.

Essential Control Settings

MODE = 2
Setpoint MODE = 1 (no priority)
2 (priority)

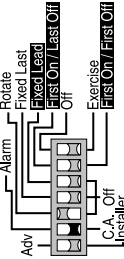

required

optional

tekmar Control Systems Ltd., Canada; tekmar Control Systems, Inc., U.S.A.; www.tekmarcontrols.com
Head Office: 5100 Silver Star Road, Vernon, B.C. Canada, V1B 3K4; (250) 545-7749 Fax (250) 545-0650

- A1 = DHW Aquastat
- A2 = Alarm
- P1 = Primary System Pump
- P2 = Boiler Pump
- P3 = DHW Pump
- S1 = Boiler Supply Sensor 071
- S2 = Outdoor Sensor 070
- R1 = Relay 004
- V1 = Pressure Differential Bypass Valve
- Z1...Z3 = Zone Valve

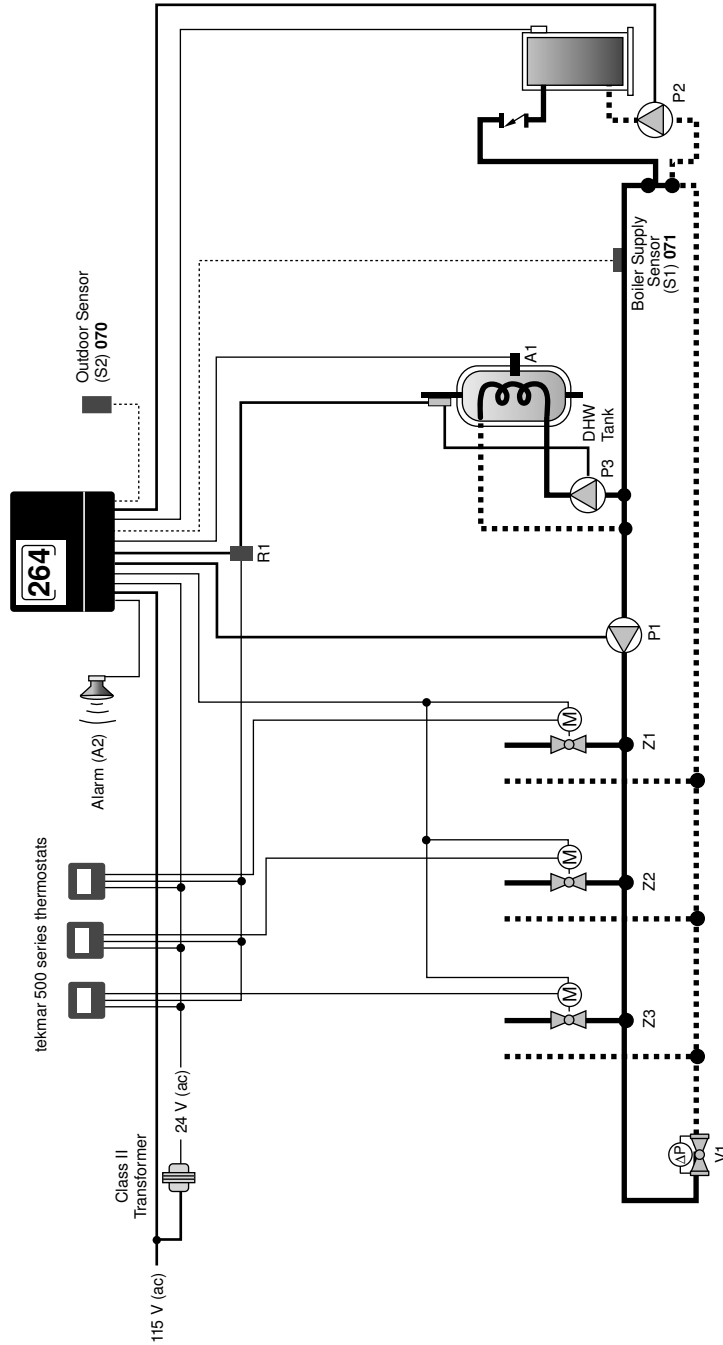

Concept Drawing

This is only a concept drawing, not an engineered drawing. It is not intended to describe a complete system, nor any particular system. It is up to the system designer to determine the necessary components for and configuration of the particular system being designed, including additional equipment, isolation relays (for loads greater than the control's specified output ratings), and any safety devices which in the judgement of the designer are appropriate, in order to properly size, configure and design that system and to ensure compliance with building and safety code requirements.

System Operation

The Boiler Control 264 provides outdoor reset to a space heating system and domestic hot water exchange temperature for an indirect domestic hot water tank. The 264 provides staging for a single three-stage boiler. The boiler is piped in primary-secondary to the space heating load. The boiler pump is controlled by the 264 to allow for post purging of the boiler after it has shut off. The domestic hot water load is piped in primary-secondary to the space heating load. The 264 has an alarm contact that closes during an error message.

tekmar Control Systems Ltd., Canada; tekmar Control Systems, Inc., U.S.A.; www.tekmarcontrols.com
Head Office: 5100 Silver Star Road, Vernon, B.C. Canada, V1B 3K4; (250) 545-7749 Fax (250) 545-0650

- A1 = DHW Aquastat
- A2 = Alarm
- P1 = Primary System Pump
- P2 = Boiler Pump
- P3 = DHW Pump
- S1 = Boiler Supply Sensor 071
- S2 = Outdoor Sensor 070
- R1 = Relay 004
- Z1...Z3 = Zone Valve

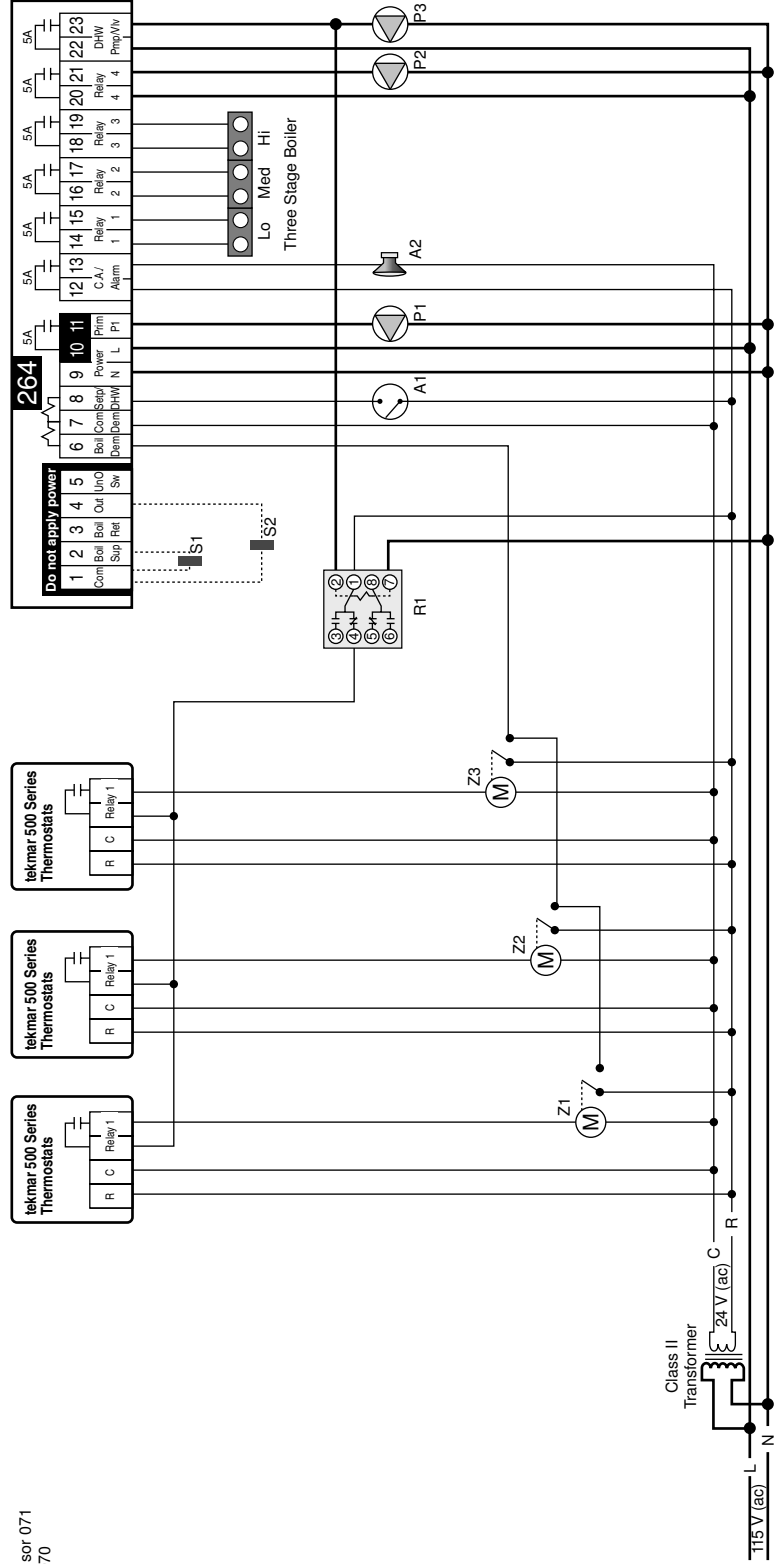

Concept Drawing
 This is only a concept drawing, not an engineered drawing. It is not intended to describe a complete system, nor any particular system. It is up to the system designer to determine the necessary components for and configuration of the particular system being designed, including additional equipment, isolation relays (for loads greater than the control's specified output ratings), and any safety devices which in the judgement of the designer are appropriate, in order to properly size, configure and design that system and to ensure compliance with building and safety code requirements.

Essential Control Settings
 MODE = 4
 DHW MODE = 4 (with priority)

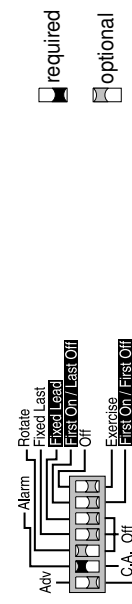

tekmar Control Systems Ltd., Canada; tekmar Control Systems, Inc., U.S.A.; www.tekmarcontrols.com
Head Office: 5100 Silver Star Road, Vernon, B.C. Canada, V1B 3K4; (250) 545-7749 Fax (250) 545-0650

A1 = DHW Aquastat
A2 = Alarm
P1 = Primary System Pump
S1 = Boiler Supply Sensor 071
S2 = Outdoor Sensor 070

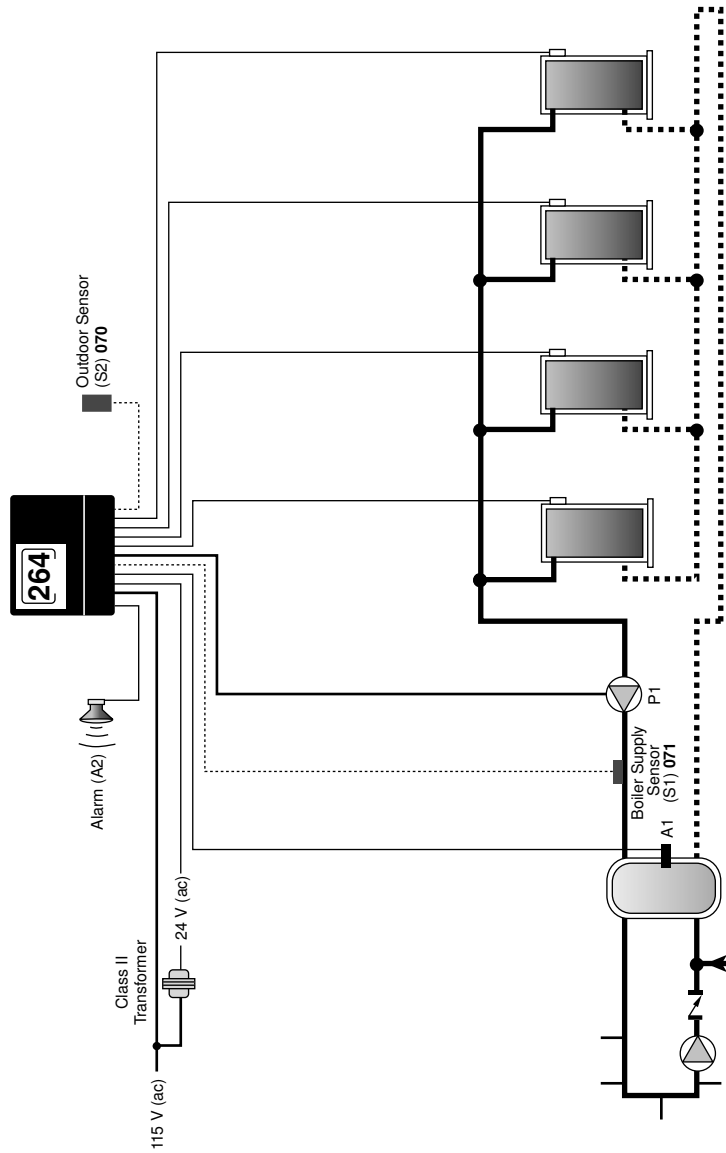

Concept Drawing

This is only a concept drawing, not an engineered drawing. It is not intended to describe a complete system, nor any particular system. It is up to the system designer to determine the necessary components for and configuration of the particular system being designed, including additional equipment, isolation relays (for loads greater than the control's specified output ratings), and any safety devices which in the judgement of the designer are appropriate, in order to properly size, configure and design that system and to ensure compliance with building and safety code requirements.

System Operation

The Boiler Control 264 provides domestic hot water operation to a single indirect domestic hot water tank. The 264 provides staging and rotation to four single stage boilers. The boilers are piped in reverse return with a single pump. The 264 has an alarm contact that closes during an error message.

tekmar Control Systems Ltd., Canada; tekmar Control Systems, Inc., U.S.A.; www.tekmarcontrols.com
Head Office: 5100 Silver Star Road, Vernon, B.C. Canada, V1B 3K4; (250) 545-7749 Fax (250) 545-0650

A1 = DHW Aquastat
 A2 = Alarm
 P1 = Primary System Pump
 S1 = Boiler Supply Sensor 071
 S2 = Outdoor Sensor 070

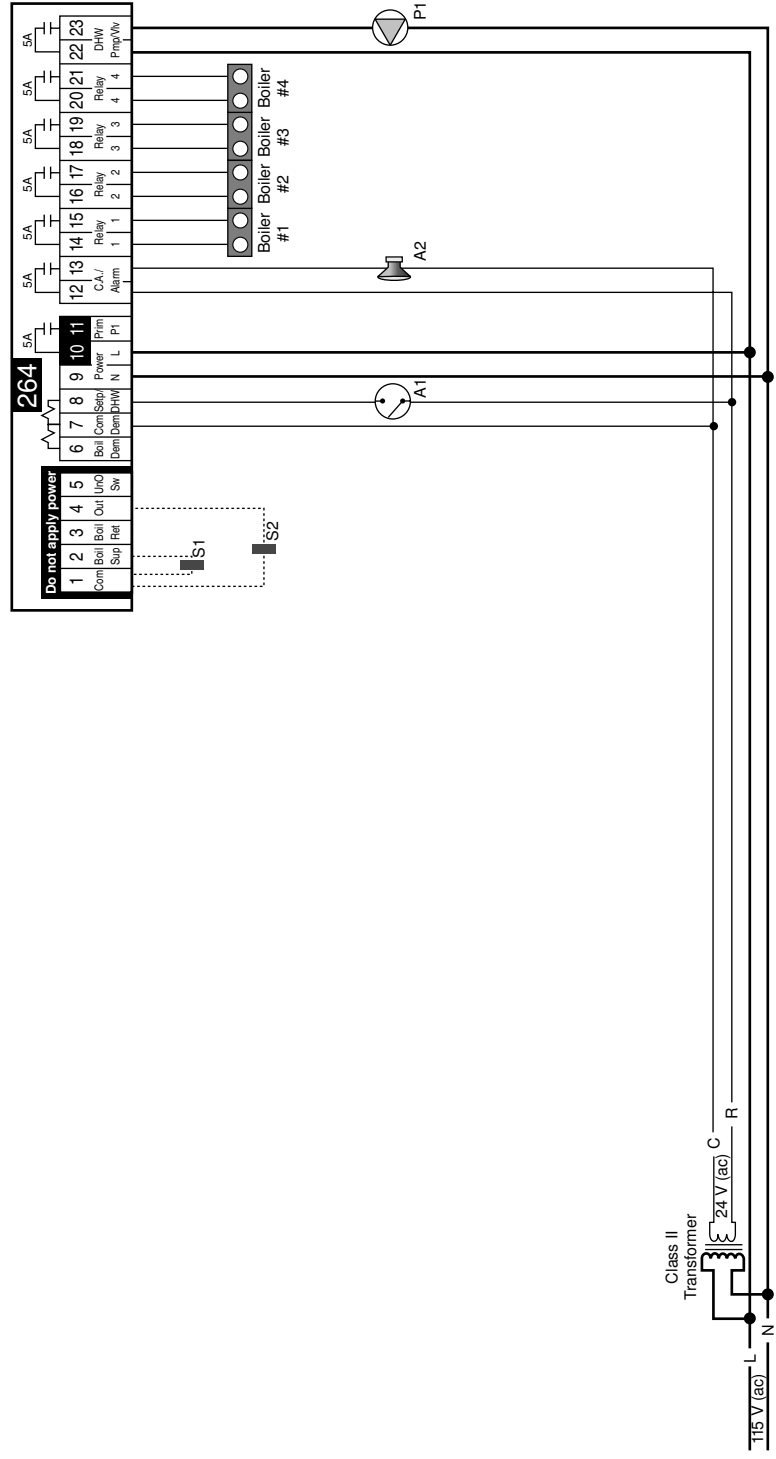

Concept Drawing
 This is only a concept drawing, not an engineered drawing. It is not intended to describe a complete system, nor any particular system. It is up to the system designer to determine the necessary components for and configuration of the particular system being designed, including additional equipment, isolation relays (for loads greater than the control's specified output ratings), and any safety devices which in the judgement of the designer are appropriate, in order to properly size, configure and design that system and to ensure compliance with building and safety code requirements.

Essential Control Settings
 MODE = 1
 DHW MODE = 1

required
 optional

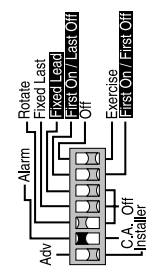

tekmar Control Systems Ltd., Canada; tekmar Control Systems, Inc., U.S.A.; www.tekmarcontrols.com
Head Office: 5100 Silver Star Road, Vernon, B.C. Canada, V1B 3K4; (250) 545-7749 Fax (250) 545-0650

Specifications

The following are the recommended specifications for the Boiler Control 264

- The control shall be able to operate boilers that have one, two, three or four independent on / off stages.
- The control shall have the ability to calculate the boilers' target temperature based on outdoor reset.
- The control shall have the ability to have the boilers' target temperature set using an adjustable setpoint.
- The control shall have an adjustable warm weather shut down. The warm weather shut down only applies to outdoor reset operation.
- The control shall have a primary pump contact that operates during a call for space heating.
- The control shall have the ability to operate a domestic hot water contact that operates during a domestic hot water call.
- The control shall have the ability to limit the number of boilers operated during domestic hot water calls for heat.
- The control shall have the ability to display the current temperature difference between the return temperature and the supply temperature, ΔT .
- The control shall have an option to rotate the firing sequence of the boilers and the option for rotating the boiler firing sequence shall be based on the boilers' accumulated running hours.
- The control shall use proportional, integral and derivative (PID) logic when staging boiler stages.
- The control shall have an adjustable Minimum Supply water temperature setting to help prevent condensation of flue gases and subsequent corrosion and blockage of the boilers' heat exchanger and chimney.
- The control shall have the option of an automatic differential calculation in order to prevent short cycling of the stages.
- The control shall have the ability to operate a primary pump plus individual boiler pumps based on the mode of operation selected.
- The boiler pumps shall have an adjustable post purge setting that allows the pump to run for a set period of time after the boiler has been shut off.
- The control shall have the option of staging multistage boilers in either a Low – High sequence or a Low – Low sequence.
- The control shall have the option for a fixed lead rotation and when this option is selected, the control shall have an option for either a first on / first off, or first on / last off firing sequence.
- The control shall have the option for a fixed last rotation.
- The control shall have the option for either an alarm output or a combustion air damper output. If the combustion air damper output is selected, the control shall have an adjustable combustion air damper opening time.
- The control shall have an adjustable minimum inter-stage delay that can be set manually or calculated automatically by the control.
- The control shall have two separate lockable access levels to limit the number of adjustments available to various users.
- The control shall have a test button that activates a pre-programmed test sequence testing all the control's outputs.
- The control shall show a number of current sensor temperatures depending on the access level that has been selected.
- The control shall continually monitor its temperature sensors and provide an error message upon a control or sensor failure.
- The control shall record and display the running hours of each boiler.
- During extended periods of inactivity, the pumps or valves that are operated by the control shall be periodically exercised to prevent seizure during long idle periods.



tekmar Control Systems Ltd., Canada
tekmar Control Systems, Inc., U.S.A.
Head Office: 5100 Silver Star Road
Vernon, B.C. Canada V1B 3K4
(250) 545-7749 Fax. (250) 545-0650
Web Site: www.tekmarcontrols.com