

Radiant Basic Heating Control



Installation Manual



March 2009

The Viega Basic Heating Control is designed to control the supply water temperature to a hydronic system in order to provide outdoor reset operation. The Basic Heating Control uses a floating action actuator mounted on a diverting or mixing valve to regulate the supply water temperature. The control has a Liquid Crystal Display (LCD) to view system status and operating information.

Additional functions include:

- User comfort adjustment to increase or decrease building space temperature
- Advanced settings to fine-tune building requirements
- Optional indoor sensor for room air temperature control
- Test sequence to ensure proper component operation
- 120 VAC power supply
- Powered system circulator pump output
- CSA C US certified (approved to applicable UL standards)

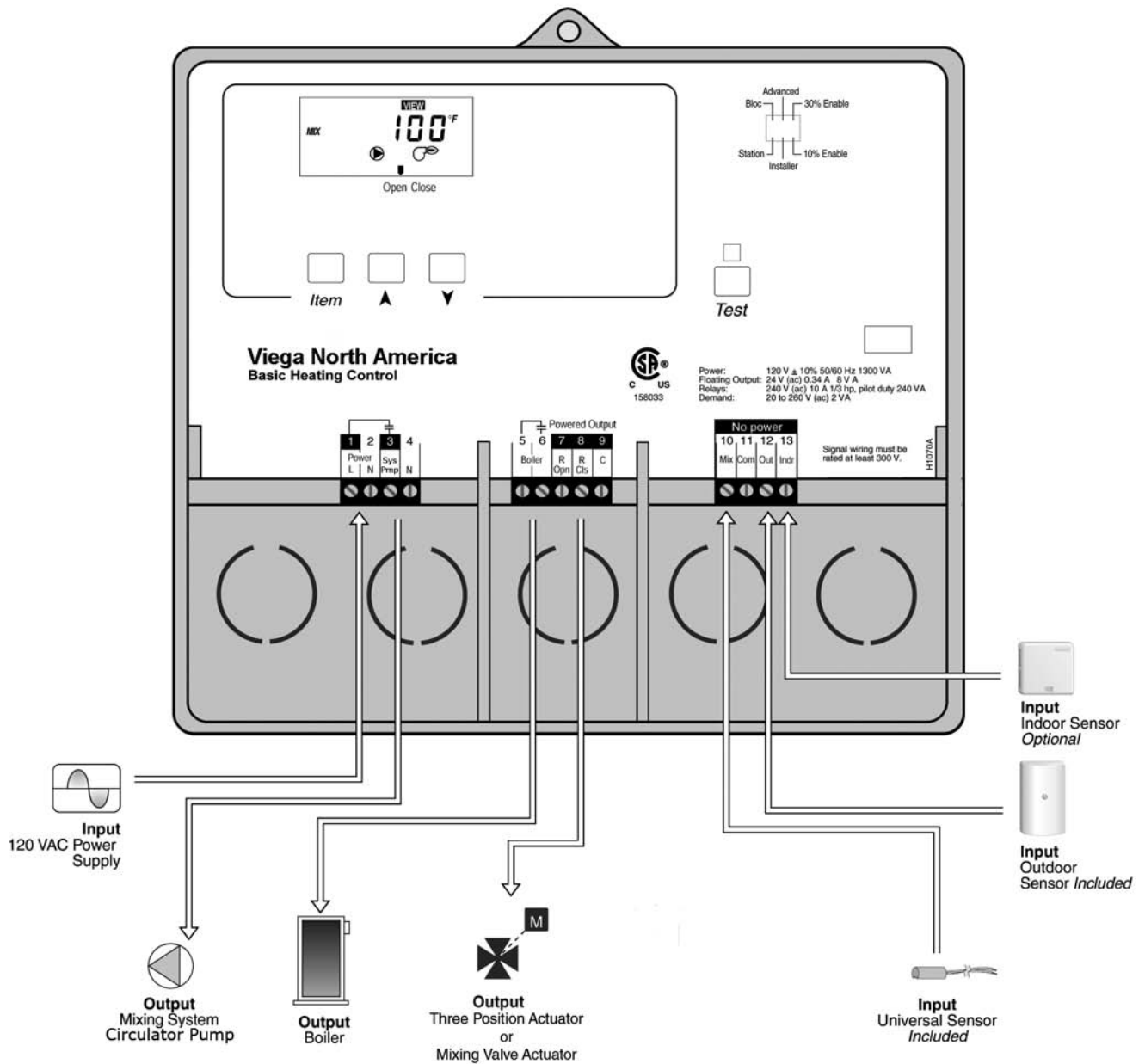

CONTENTS

1 General Operation	
1.1 Using the Control	4
1.2 Description of Display	4
2 Control Operation	
2.1 General Operation	5
2.2 Control Features	5
3 Temperature Control	
3.1 General Information	6
3.2 Installer Information	6
3.3 Advanced Information	6
4 Boiler Control	7
5 Installation	
5.1 Mounting & Rough-in	8
5.2 Electrical Connections	10
5.3 Testing the Wiring	11
5.4 DIP Switch Settings	13
5.5 View Menu Settings	13
5.6 Adjust Menu Settings	14
5.7 Testing	15
6 Troubleshooting	16
7 Mechanical and Electrical Diagrams	18
8 Technical Data	20

How To Use This Instruction Manual

This manual is organized into the following four main topics:

Operation (Sections 1 and 2), which describes how to read the control and use the LCD display

Control (Sections 3 and 4), which discusses how the mixing device and boiler are controlled

Installation (Section 5), which details the mounting and connection process for the control and sensors

Troubleshooting, Mechanical, and Technical Data (Sections 6, 7, and 8), which provide help with fixing problems and correcting errors.

We recommend first reading Sections 1 and 2, as these contain important information on the overall operation and use of the control. For a quick installation and setup of the control, refer to Section 5, Installation. Mount and connect the control as described in Sections 5.1 - 5.3, and then set the DIP switches and the parameters of the control as discussed in Sections 5.4 and 5.6.

The Installation section (starting at 5.4 DIP Switch Settings) of this manual describes the various items that are adjusted and displayed by the control. The control functions of each adjustable item are described in Sections 3 and 4.

1 General Operation

1.1 Using the Control

The Basic Heating Control uses a Liquid Crystal Display (LCD) as the method of supplying information. You use the LCD in order to set up and monitor the operation of your system. The Basic Heating Control has three push buttons (**Item**, **▲**, **▼**) for selecting and adjusting settings. As you program your control, record your Adjust Menu settings for future reference or troubleshooting.

Item

The abbreviated name of the selected item will be displayed in the item field of the display. To view the next available item, press and release the **Item** button. Once you have reached the last available item, pressing and releasing the **Item** button will return the display to the first item.

Adjust

To make an adjustment to a setting in the control, press and hold simultaneously for 1 second, the **Item**, **▲** and **▼** buttons. The display will then show the word **ADJUST** in the top right corner. Then select the desired item using the **Item** button. Finally, use the **▲** and/or **▼** button to make the adjustment.

To exit the adjust menu, the control must be left alone for 20 seconds.

When the **Item** button is pressed and held in the **VIEW** menu, the control scrolls through all the control adjust items in both access levels.

Additional information can be gained by observing the Status field and Pointers of the LCD. The Status field will indicate which of the control's outputs are currently active. Most symbols in the status field are only visible when the **VIEW** menu is selected.

1.2 Description of Display

Circulator
 Displays when the system circulator is in operation

Burner
 Displays when the boiler relay is turned on

°F, °C
°F Displays the units of measurement that all of the temperatures are to be displayed in the control
°C

Pointer
 Displays the actuator operation as indicated (open/close)

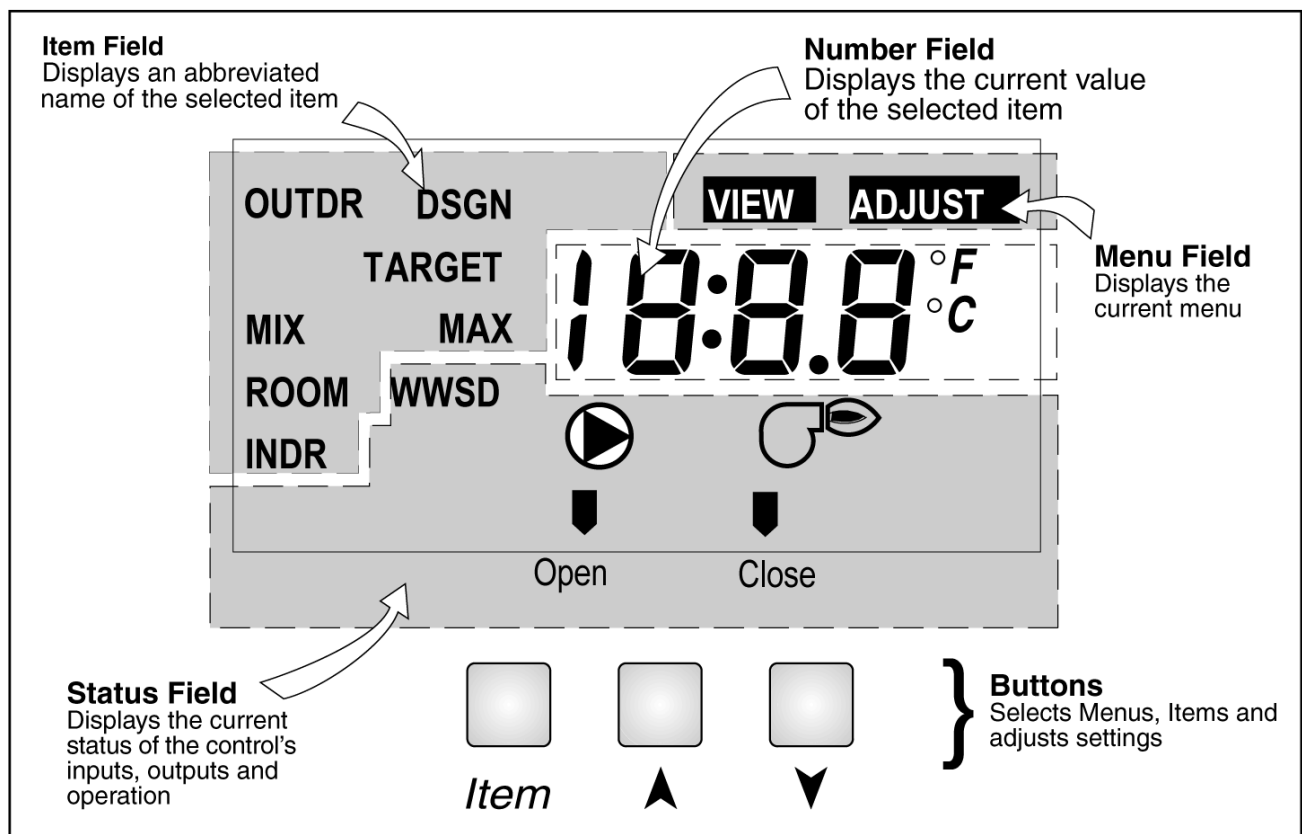

2 Control Operation

2.1 General Operation

When the Basic Heating Control is powered up, the control displays the control type number in the LCD for 2 seconds. Next, the software version is displayed for 2 seconds. Finally, the control enters into the normal operating mode.

The Basic Heating Control uses a floating action mixing or injection valve to vary the supply water temperature to a hydronic system. The supply water temperature is based on the outdoor temperature.

The maximum water temperature setting in the Basic Heating Control should not be used as a safety high limit control. To protect floors from high water temperatures in case of main control failure or removal, use a Viega Modulating Safety High Limit Control (stock code 16116) on the outlet injection valve of the Injection Station.

2.2 Control Features

2.2.1 Outdoor Reset

The Basic Heating Control calculates a mixing supply water temperature based on the outdoor air temperature. The Basic Heating Control uses a heating curve and optional indoor temperature feedback from an indoor sensor in this calculation.

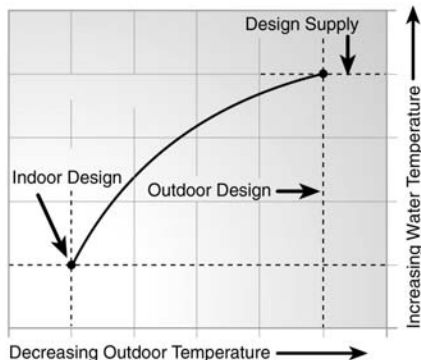

2.2.2 Floating action

A 24 V (AC) floating action actuator motor is connected directly to the Basic Heating Control on the Com, Opn and Cls terminals (7, 8, and 9). The Basic Heating Control pulses the actuator motor open or closed to maintain the correct mixed supply water temperature at the supply sensor. The valve that the actuator is connected to can be either an injection valve (on the Injection Station), a mixing valve, or a diverting valve. A visual indication as to whether the control is currently opening or closing the mixing valve is displayed in the LCD.

2.2.3 Warm Weather Shut Down

The Basic Heating Control monitors the outdoor temperature and shuts off the heating system seasonally when outdoor temperatures exceed the WWSD setting. This reduces energy use during the summer when the heating system is not needed and saves wear on system components. To prevent the system from seizing due to long periods of no use, the circulator, actuator, and valve are exercised periodically (see below).

2.2.4 Exercising

The Basic Heating Control has a built-in exercising function. If the system pump or valve has not been operated at least once every 3 days, the control turns on the output for a minimum of 10 seconds. This minimizes the possibility of a circulator pump or valve seizing during a long period of inactivity. The Basic Heating Control ensures that the mixing valve operates over its entire range at least once each exercising period. While the control is exercising, the Test LED flashes.

Note: The exercising function does not work if power to the control, circulator, or valve is disconnected.

3 Temperature Control

3.1 General Information

SYSTEM CIRCULATOR PUMP OPERATION (Sys Pmp)

The system circulator pump contact (Sys Pmp, terminal 3) remains closed as long as the Basic Heating Control is not in Warm Weather Shut Down. During WWSD, the system Circulator is operated periodically based on the Exercise feature.

MIXING TARGET TEMPERATURE (MIX TARGET)

The MIX TARGET temperature is calculated from the heating curve settings, outdoor air temperature, and optionally, indoor air temperature. The control displays the temperature that it is currently trying to maintain as the mixing supply temperature.

INDOOR SENSOR (optional)
An indoor sensor may be used in order to provide indoor temperature feedback. The indoor sensor is connected to the Com and Indr terminals (11 and 13). With the indoor sensor connected, the Basic Heating Control is able to sense the actual room temperature. With this information, the Basic Heating Control fine-tunes the supply water temperature in the mixing system to prevent overheating or underheating. To adjust the room temperature for the mixing zone, use the ROOM setting in the **ADJUST** menu at the control.

If a multiple zone system with thermostats is used with an indoor sensor, proper placement of the indoor sensor is essential. The indoor sensor should be located in an area that best represents the highest heat loss of the zones. Mount it on an inside wall, away from drafts, heat sources, or direct sunlight.

3.2 Installer Information

OUTDOOR DESIGN (OUTDR DSGN)

The OUTDR DSGN is the outdoor air temperature that is typically the coldest temperature of the year where the building is located. This temperature is used when performing the heat loss calculations for the building. If a cold outdoor design temperature is selected, the mixing supply temperature rises gradually as the outdoor temperature drops. If a warm outdoor design temperature is selected, the mixing supply temperature rises rapidly as the outdoor temperature drops.

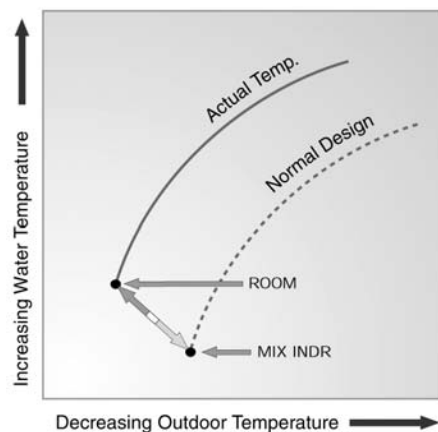
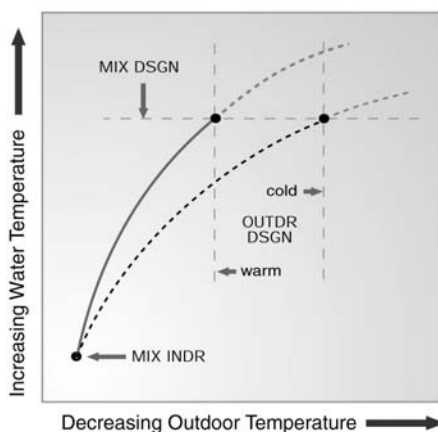

ROOM (ROOM)

The ROOM is the desired room temperature for the mixing zones and it provides a parallel shift

of the Heating Curve. The room temperature desired by the occupants is often different from the design indoor temperature (MIX INDR). If the room temperature is not correct, adjusting the ROOM setting increases or decreases the amount of heat available to the building.

MIX DESIGN (MIX DSGN)

The MIX DSGN temperature is the supply water temperature required to heat the mixing zones when the outdoor air is as cold as the OUTDR DSGN temperature.

3.3 Advanced Information

MIXING INDOOR (MIX INDR)

The MIX INDR is the room temperature used in the original heat loss calculations for the building. This setting establishes the beginning of the Heating Curve for the mixing zones.

MIXING MAXIMUM (MIX MAX)

The MIX MAX sets the highest water temperature that the control is allowed to calculate as the MIX TARGET temperature. If the control does target the MIX MAX setting, and the MIX temperature is near the MIX MAX, the MAX segment will be displayed in the LCD while either the MIX TARGET temperature or the MIX temperature is being viewed.

WARM WEATHER SHUT DOWN (WWSD)

When the outdoor air temperature rises above the WWSD setting, the Basic Heating Control turns on the WWSD segment in the display. When the control is in Warm Weather Shut Down, the control does not operate the heating system (except for exercising - see section 2.2.4).

4 Boiler Control

4.1 Boiler Operation

When the Basic Heating Control determines that boiler operation is required, the Boiler contact terminals (5 and 6) close. While the Boiler contact is closed, the burner segment in the LCD is displayed.

4.2 Boiler Enable

(Boiler Enable 30% / Boiler Enable 10%)

The Basic Heating Control has a DIP switch that allows for the selection between a 30% boiler enable and a 10% boiler enable. In the 30% position, the Basic Heating Control closes the boiler contact when the position of the mixing valve exceeds 30%. The boiler contact remains closed until the position of the mixing valve reduces below 15%. This setting would normally be chosen for low mass boilers (copper fin tube, etc.), or systems with low thermal mass in the loop between the boiler and the mixing valve (recommended for most Viega applications).

In the 10% position, the Basic Heating Control closes the boiler contact when the position of the mixing valve exceeds 10%. The boiler contact remains closed until the position of the mixing valve reduces below 5%. This setting is normally chosen for high mass boilers (cast iron, steel fire tube, etc.) or systems with large thermal mass in the loop between the boiler and the mixing valve.

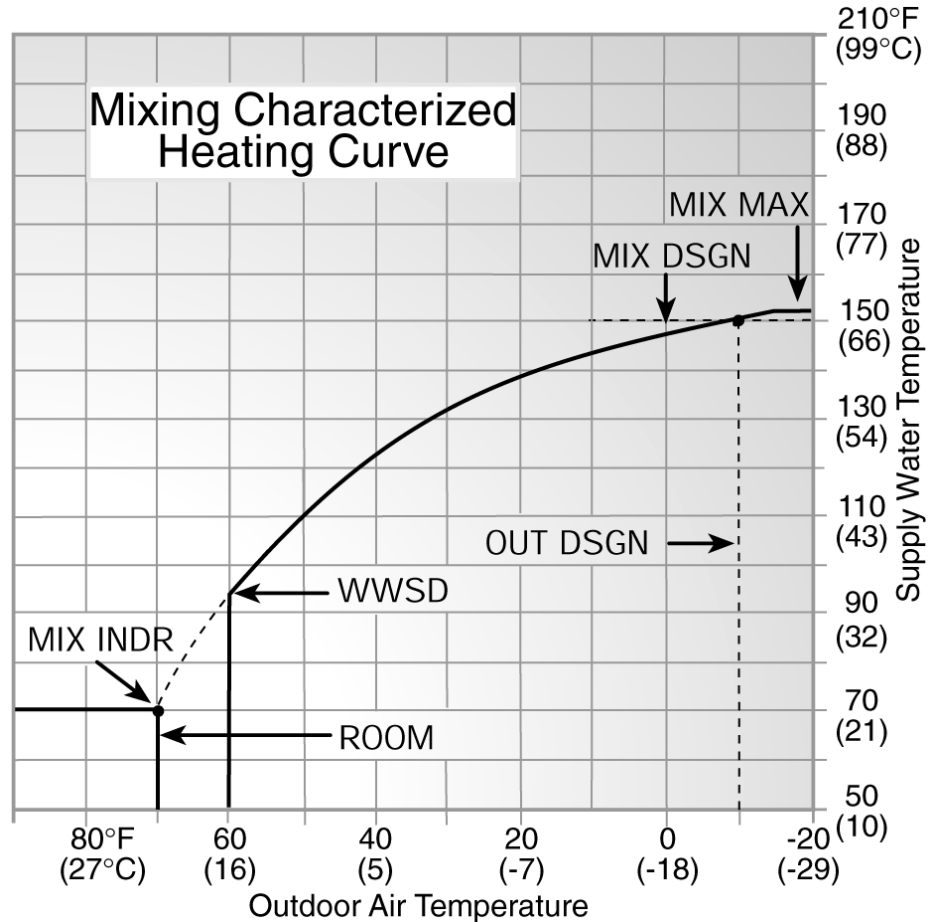

5 Installation

CAUTION

Improper installation and operation of this control could result in damage to the equipment and possibly even personal injury. It is your responsibility to ensure that this control is safely installed according to all applicable codes and standards. This electronic control is not intended for use as a primary limit control. Other controls that are intended and certified as safety limits must be placed into the control circuit.

5.1 Mounting and Rough-in

Check the contents of this package. If any of the contents listed are missing or damaged, please contact your wholesaler or sales representative for assistance.

The Basic Heating Control includes: One Basic Heating Control, One Outdoor Sensor, and One Supply Sensor.

Note: Carefully read the details of the Sequence of Operation to ensure that you have chosen the proper control for your application.

Mounting

Remove the control from its base by pressing down on the release clip in the wiring chamber and sliding the control upward. The base may then be mounted by screwing it to a wall or mounting board (screws not included).

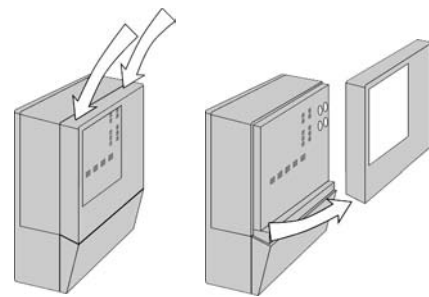
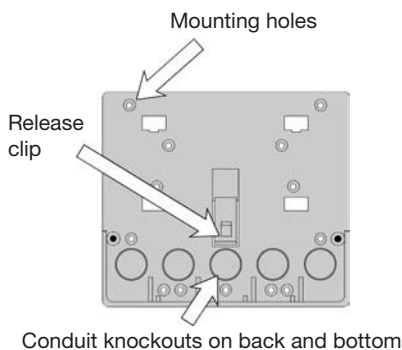

Press down at grips on top of cover, then pull out and down to release cover.

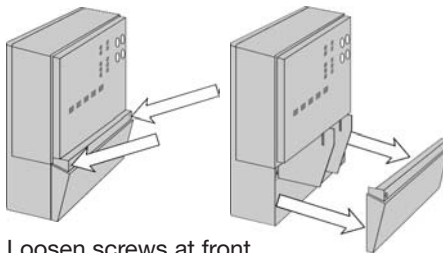

Loosen screws at front and pull wiring cover straight out.

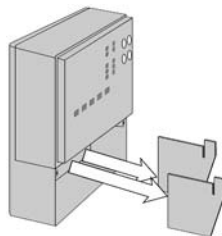

Remove safety dividers by pulling them straight out.

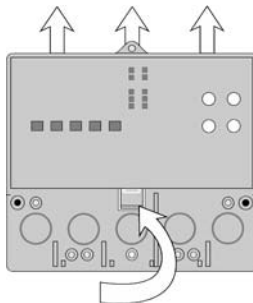

Press release clip on base and slide control upward.

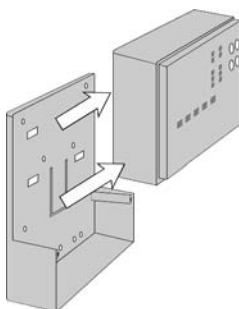

The control lifts up and away from the base, which is ready for mounting.

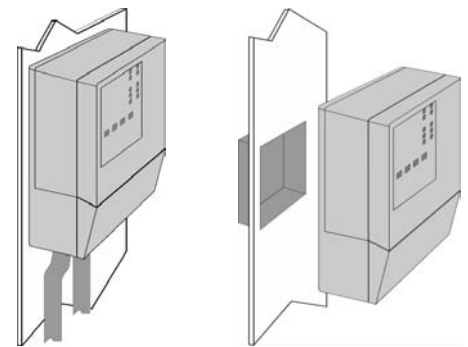

Wiring can enter from bottom or back of enclosure. Knockouts allow wiring to be run in conduit.

Rough-in

All electrical wiring terminates in the control base wiring chamber. The base has standard 7/8" (22 mm) knockouts, which accept common wiring hardware and conduit fittings. Before removing the knockouts, check the wiring diagram and select those sections of the chamber with common voltages. Do not allow the wiring to cross between sections as the wires will interfere with safety dividers that should be installed at a later time.

Power must not be applied to any of the wires during the rough-in wiring stage.

- Install the Outdoor Sensor and Supply Sensor according to the instructions on page 9 and run the wiring back to the control.
- If an Indoor Sensor (optional) is used, install the sensor according to the instructions included with it and run the wiring back to the control.
- Run wire from other system components (circulator pump, boiler, actuating motor, etc.) to the control.
- Run wires from the 120 VAC power to the control. Use a clean power source to ensure proper operation. Multi-strand 16 AWG wire is recommended for all 120 VAC wiring due to its superior flexibility and ease of installation into the terminals.

Installing the Outdoor Sensor

The Outdoor Sensor includes a 10kΩ thermistor that provides an accurate measurement of the outdoor temperature. The sensor is protected by a white U.V. resistant plastic enclosure.

Remove the screw and pull the front cover off the sensor enclosure.

The Outdoor Sensor can either be mounted directly onto a wall or a 2" x 4" electrical box. When the sensor is wall mounted, the wiring should enter through the back or bottom of the enclosure. Do not mount the sensor with the conduit knockout facing upward as rain could enter the enclosure and damage the sensor.

In order to prevent heat transmitted through the wall from affecting the sensor reading, it may be necessary to install an insulating barrier behind the enclosure.

The Outdoor Sensor should be mounted on a wall that best represents the heat load on the building (a northern wall for most buildings, and a southern facing wall for buildings with large south facing glass areas). The sensor should not be exposed to heat sources such as ventilation or window openings.

The Outdoor Sensor should be installed at an elevation above the ground that will prevent accidental damage or tampering, and where it will not be covered by drifting snow during the winter.

Connect 18 AWG or similar wire to the two terminals provided in the enclosure and run the wires from the sensor to the control. Do not run the wires parallel to telephone or power cables. If the sensor wires are located in an area with strong sources of electromagnetic interference (EMI), shielded cable or twisted pair should be used or the wires can be run in a grounded metal conduit. If using shielded cable, the shield wire should be connected to the COM sensor terminal on the control and not to earth ground.

Replace the front cover of the sensor enclosure.

When more than one Basic Heating Control is used on a project, the Outdoor Sensors can be combined into one enclosure by adding the Multiple Outdoor Sensor module (stock code 16020). This mounts in the Outdoor Sensor enclosure and allows up to four controls to have outdoor sensors within one enclosure.

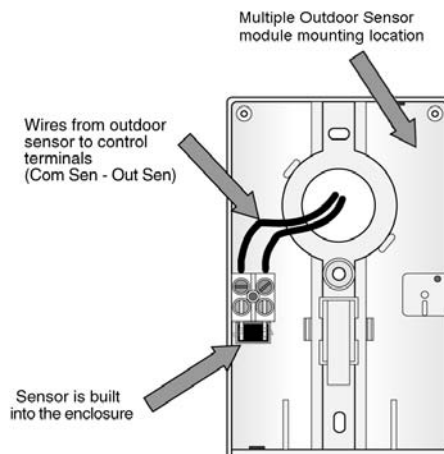

Installing the Supply Sensor

Note: This sensor is designed to mount on a pipe or in a temperature immersion well.

The Supply Sensor can be strapped directly to the pipe using a plastic cable tie. Insulation should be placed around the sensor to reduce the effect of air currents on the sensor measurement.

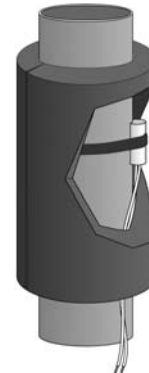

The Supply Sensor should be placed downstream of a pump or after an elbow or similar fitting. This is especially important if large diameter pipes are used, as the thermal stratification within the pipe can result in erroneous sensor readings. Proper sensor location requires that the fluid is thoroughly mixed within the pipe before it reaches the sensor. When using the Supply Sensor with a Viega Mixing or Injection Station, insert the sensor into the immersion well on the elbow below the circulator pump.

Connect 18 AWG or similar wire to the two wires of the sensor and then to the control. Do not run the wires parallel to telephone or power cables. If the sensor wires are located in an area with strong sources of electromagnetic interference (EMI), shielded cable or twisted pair should be used or the wires can be run in a grounded metal conduit. If using shielded cable, the shield wire should be connected to the COM sensor terminal on the control and not to earth ground.

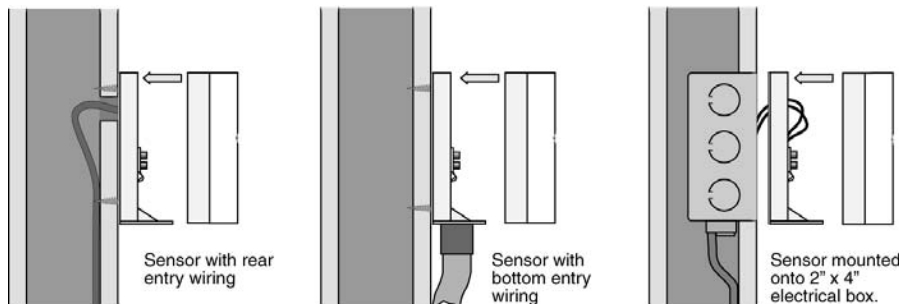

5.2 Electrical Connections

The installer should test to confirm that no voltage is present at any of the wires. Push the control into the base and slide it down until it snaps firmly into place.

Powered Input Connection

120 VAC POWER

Connect the 120 VAC power supply to the Power L and Power N terminals (1 and 2). This connection provides power to the microprocessor and display of the control. As well, this connection provides power to the Sys Pmp terminal (3) from the Power L terminal (1).

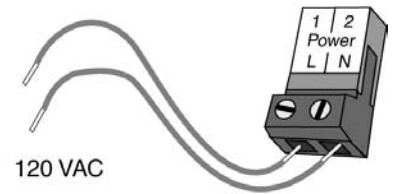

Output Connections

SYSTEM CIRCULATOR PUMP CONTACTS (SYS PMP)

The Sys Pmp output terminal (3) on the Basic Heating Control is a powered output. When the relay in the Basic Heating Control closes, 120 VAC is provided to the Sys Pmp terminal (3) from the Power L terminal (1). To operate the system circulator, connect one side of the system circulator circuit to terminal (3) and the second side of the circulator circuit to the neutral (N) terminal (4).

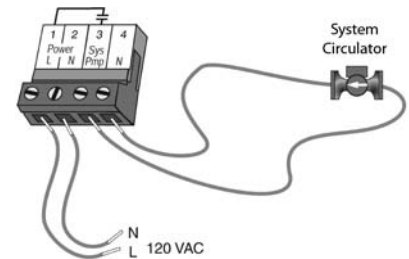

VALVE ACTUATOR

Terminals 7, 8, and 9 are powered with 24 VAC from the control. There is no need to provide a separate 24 VAC power source for the valve actuator. R Opn (7) is connected to the open terminal of the actuating motor and R Cls (8) is connected to the close terminal of the actuating motor. C (9) is then connected to the common terminal of the actuating motor.

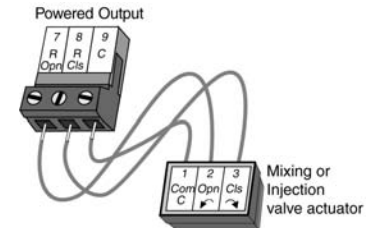

Three Position Actuator for Stations (18003)

- White wire is common
- Green wire is open
- Brown wire is close

Mixing Valve Actuator (20040)

- Blue wire is common
- Brown wire is clockwise rotation
- Black wire is counter-clockwise rotation
- (Whether clockwise is open or close will depend on the orientation of the Mixing Valve – see valve instructions for details)

BOILER CONTACT

The Boiler terminals (5 and 6) are an isolated (dry) output in the Basic Heating Control. There is no power available on these terminals from the control. These terminals are to be used as a switch to either make or break the boiler circuit. When the Basic Heating Control requires the boiler to fire, it closes the contact between terminals 5 and 6.

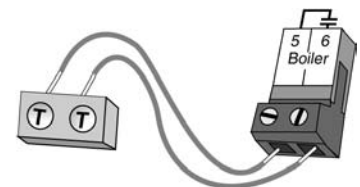

Sensor and Unpowered Input Connections

Do not apply power to these terminals as this will damage the control.

OUTDOOR SENSOR

Connect the two wires from the Outdoor Sensor to the Com and Out terminals (11 and 12). The Outdoor Sensor is used by the Basic Heating Control to measure the outdoor air temperature.



SUPPLY SENSOR

Connect the two wires from the Supply Sensor to the Com and Mix terminals (10 and 11). The Supply Sensor is used by the Basic Heating Control to measure the supply water temperature downstream of the mixing or injection valve.

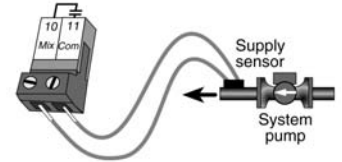

INDOOR SENSOR

If an optional indoor sensor is used, connect the two wires from the sensor to the Com and Indr terminals (11 and 13).



5.3 Testing the Wiring

Each terminal block **must be unplugged** from its header on the control before power is applied for testing. To remove the terminal block, pull straight down from the control.

The following tests are to be performed using standard testing practices and procedures and should only be carried out by properly trained and experienced persons.

A good quality electrical test meter, capable of reading at least 0 - 300 VAC and at least 0 - 2,000,000 Ohms, is essential to properly test the wiring and sensors.



Test the Sensors

In order to test the sensors, the actual temperature at each sensor location must be measured. A good quality digital thermometer with a surface temperature probe is recommended for ease of use and accuracy. Where a digital thermometer is not available, a spare sensor can be strapped alongside the one to be tested and the readings compared. Test the sensors according to the instructions on page 15.

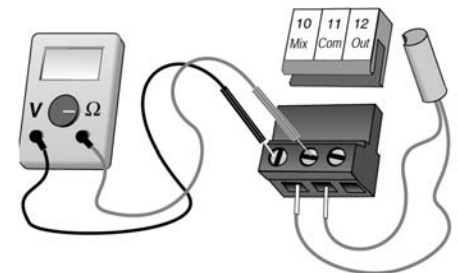

Test the Power Supply

Make sure exposed wires and bare terminals are not in contact with other wires or grounded surfaces. Turn on the power and measure the voltage between the Power L and Power N terminals (1 and 2) using an AC voltmeter. The reading should be between 108 and 132 VAC.

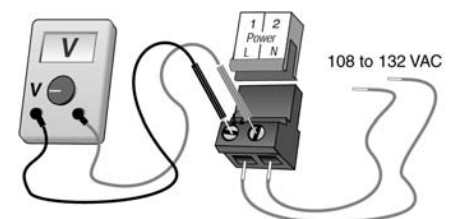

Test the Outputs

SYSTEM CIRCULATOR PUMP (SYS PMP)

If a system circulator pump is connected to the Sys Pmp terminal (3) and N terminal (4), make sure that power to the terminal block is off and install a jumper between the Power L and the Sys Pmp terminals (1 and 3). Install a second jumper between the Power N and N terminals (2 and 4). When power is applied to the Power L and Power N terminals (1 and 2), the system circulator pump should start. If the circulator pump does not turn on, check the wiring between the terminal block and circulator pump and refer to any installation or troubleshooting information supplied with the circulator pump. If the pump operates properly, disconnect the power and remove the jumpers.

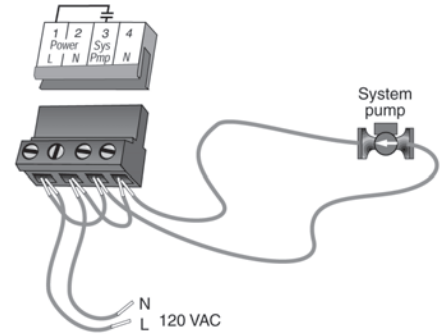

BOILER

If the boiler is connected to the Boiler terminals (5 and 6), make sure power to the boiler circuit is off and install a jumper between the terminals. When the boiler circuit is powered up, the boiler should fire. If the boiler does not turn on, refer to any installation or troubleshooting information supplied with the boiler. (The boiler may have a flow switch that prevents firing until the boiler pump is running.) If the boiler operates properly, disconnect the power and remove the jumper.

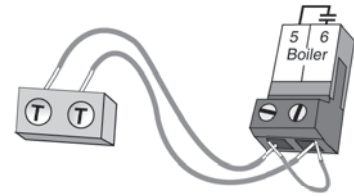

Connecting the Control

Make sure all power to the devices and terminal blocks is off and remove any remaining jumpers from the terminals.

Reconnect the terminal blocks to the control by carefully aligning them with their respective headers on the control and then pushing the terminal blocks into the headers. The terminal blocks should snap firmly into place.

Install the supplied safety dividers between the unpowered sensor inputs and the powered 120 VAC or 24 VAC wiring chambers.

Apply power to the control. The operation of the control on power up is described in section 2.1.

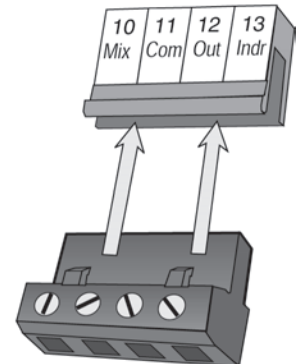

MIXING OR INJECTION VALVE ACTUATOR

If a floating action actuating motor circuit is connected to the R Opn, R Cls, and C terminals (7, 8, and 9), the control's Test Sequence can be used to check the motor circuit. Once the Test button is pressed, the valve should move to the fully open position. If the motor closes instead of opening, the wiring of the actuating motor must be reversed. Next, the actuator should move the valve to the fully closed position. If it does not, check the wiring between the terminals and the actuating motor. Refer to any installation or troubleshooting information supplied with the actuator.

5.4 DIP Switch Settings

The DIP switch settings on the control are very important and should be set to the appropriate settings prior to making any adjustments to the control through the User Interface. The DIP switch settings change the items that are available to be viewed and/or adjusted in the User Interface.

Advanced / Installer

The Advanced/Installer DIP switch is used to select which items are available to be viewed and/or adjusted in the User Interface (see Display Settings below).

5.5 View Menu Display Settings

Visible when the control is operating (no buttons pressed for at least 20 seconds).

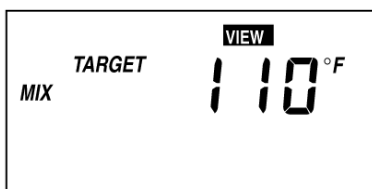
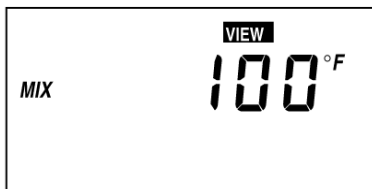
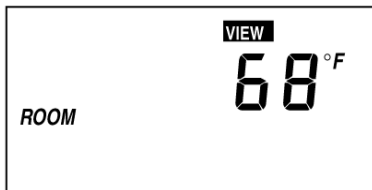
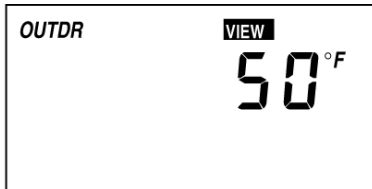

**Boiler Enable 30% -
Boiler Enable 10%**

The position of this switch determines at which valve position the control will close the Boiler contact under normal conditions. Refer to section 4.2 (page 7) for a description of the Boiler Enable DIP.

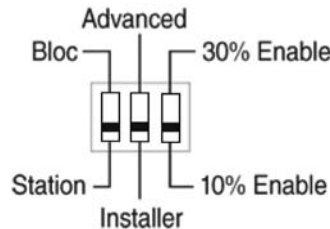

Bloc / Station

The Bloc/Station switch is used to select which method the system will use to adjust supply water temperature. The Mixing Station, Injection Station, and Diverting Valves use the Three Position Actuator (stock code 18003) with a 24 VAC floating signal to adjust the water temperature. It takes 70 seconds for full valve travel. At 50 Hz, it takes 150 seconds to fully open from fully closed. At 60 Hz it takes 120 seconds to fully open from fully closed. If using Mixing Station, Injection Station and/or Diverting Valves, set DIP switch to "Station." If using Viega's 3-4 Way Mixing Valves with Viega's Mixing Valve Actuator or the ProBloc, set DIP switch to "Bloc." The Mixing Valve Actuator (stock code 20040) takes 102 seconds to fully open from fully closed.

OUTDR

Current outdoor air temperature as measured by the outdoor sensor. This is also the default display for the control.

ROOM

Measured room air temperature as measured by the indoor sensor. (Only visible when Indoor Sensor is connected).

MIX

Current mixed supply water temperature as measured by the supply sensor.

MIX TARGET

Target mixed supply is the temperature the control is currently trying to maintain at the supply sensor. (Only visible with the Advanced/Installer DIP switch set to Advanced).

5.6 Adjust Menu Display Settings

To make an adjustment to a setting in the control, press and hold simultaneously for 1 second, the **Item**, **▲** and **▼** buttons. The display will then show the word **ADJUST** in the top right corner. Then select the desired item using the **Item** button. Finally, use the **▲** and/or **▼** button to make the adjustment. See sections 3.2 and 3.3 (page 6) for further discussion on these items and their effect on control operation.



ROOM

The desired room temperature.

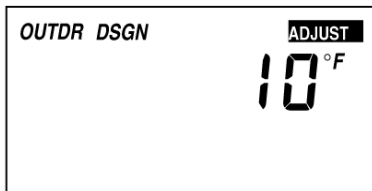

OUTDR DSGN

The design outdoor temperature used for calculating heat-loss. Obtained from the Design Outdoor Temperature Chart, or Viega’s Radiant Wizard.*

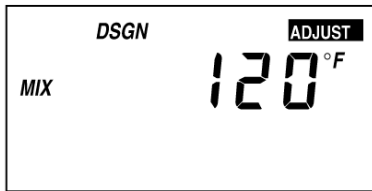

MIX DSGN

The design supply water temperature obtained from the Supply Water Temperature / BTU Output Chart, or Viega’s Radiant Wizard.

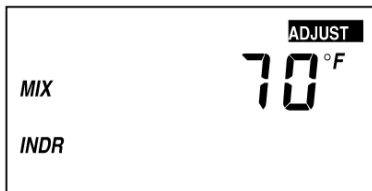

MIX INDR

The design indoor air temperature used in the heat loss calculation* for the heating system (only visible with the Advanced/Installer DIP switch set to Advanced). Should be equal to “ROOM,” the desired room temperature.

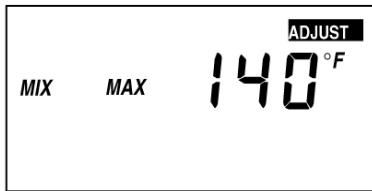

MIX MAX

The maximum supply temperature for the mixing system (only visible with the Advanced/Installer DIP switch set to Advanced). This setting should not be relied upon for a safety high limit. Install a Modulating Safety High Limit Control (stock code 16108) on the Injection Station to protect control in case of main control failure or removal. Set higher than “MIX DSGN” and account for the heat loss of distribution piping.



WWSD

Warm Weather Shut Down; the design outdoor air temperature at which the control only operates in exercising mode (only visible with the Advanced/Installer DIP switch set to Advanced).



UNITS

The units of measure that all of the temperatures are to be displayed in the control; either °F or °C.

* See corresponding installation manuals, i.e. Concrete System, Climate Panel, or Climate Trak, for appropriate charts.

5.7 Testing the Control

The Basic Heating Control has a built-in test routine that is used to test the main control functions. The Basic Heating Control continually monitors the sensors and displays an error message whenever a fault is found. See the following pages for a list of the Basic Heating Control's error messages and possible causes. When the **Test** button is pressed, the test light is turned on. The individual outputs and relays are tested in the following test sequence.



off not testing
 red testing
 >red< testing paused

Test

TEST SEQUENCE

Each step in the test sequence lasts 10 seconds.

During the test routine, the test sequence may be paused by pressing the **Test** button. If the **Test** button is not pressed again for 5 minutes while the test sequence is paused, the control exits the entire test routine. If the test sequence is paused, the **Test** button can be pressed again to advance to the next step. This can also be used to rapidly advance through the test sequence. To reach the desired step, repeatedly press and release the **Test** button until the appropriate device and segment in the display turn on.

- Step 1 - The mixing valve is run fully open.
- Step 2 - The mixing valve is run fully closed, and then the system pump (Sys Pmp) is turned on.
- Step 3 - The Boiler contact is turned on for 10 seconds. After 10 seconds, the Boiler and Sys Pmp contacts are shut off.
- Step 4 - After the test sequence is completed, the control resumes its normal operation.

Testing Sensors

A good quality test meter capable of measuring up to 5,000kΩ (1kΩ = 1000Ω) is required to measure the sensor resistance. In addition to this, the actual temperature must be measured with a good quality digital thermometer. If a thermometer is not available, a second sensor can be placed alongside the one to be tested and the readings compared.

First measure the temperature using the thermometer and then measure the resistance of the sensor at the control. The wires from the sensor must not be connected to the control while the test is performed.

Using the chart below, estimate the temperature measured by the sensor. The sensor and thermometer readings should be close. If the test meter reads a very high resistance, there may be a broken wire, a poor wiring connection, or a defective sensor. If the resistance is very low, the wiring may be shorted, there may be moisture in the sensor, or the sensor may be defective. To test for a defective sensor, measure the resistance directly at the sensor location.

Do not apply voltage to a sensor at any time as damage to the sensor may result.

Temperature		Resistance	Temperature		Resistance
°F	°C	Ω	°F	°C	Ω
-50	-46	490,813	90	32	7,334
-45	-43	405,710	95	35	6,532
-40	-40	336,606	100	38	5,828
-35	-37	280,279	105	41	5,210
-30	-34	234,196	110	43	4,665
-25	-32	196,358	115	46	4,184
-20	-29	165,180	120	49	3,760
-15	-26	139,402	125	52	3,383
-10	-23	118,018	130	54	3,050
-5	-21	100,221	135	57	2,754
0	-18	85,362	140	60	2,490
5	-15	72,918	145	63	2,255
10	-12	62,465	150	66	2,045
15	-9	53,658	155	68	1,857
20	-7	46,218	160	71	1,689
25	-4	39,913	165	74	1,538
30	-1	34,558	170	77	1,403
35	2	29,996	175	79	1,281
40	4	26,099	180	82	1,172
45	7	22,763	185	85	1,073
50	10	19,900	190	88	983
55	13	17,436	195	91	903
60	16	15,311	200	93	829
65	18	13,474	205	96	763
70	21	11,883	210	99	703
75	24	10,501	215	102	648
80	27	9,299	220	104	598
85	29	8,250	225	107	553

6 Troubleshooting

When troubleshooting any heating system, it is always a good idea to establish a set routine to follow. By following a consistent routine, many hours of potential headaches can be avoided. Below is an example of a sequence that can be used when diagnosing or troubleshooting problems in a hydronic heating system.

Establish the problem. Get as much information from the customer as possible about the problem. Is there too much heat, not enough heat, or no heat? Is the problem only in one particular zone or area of the building or does the problem affect the entire system? Is this a consistent problem or only intermittent? How long has the problem existed? This information is critical in diagnosing the problem.

Understand the sequence of operation of the system. If a particular zone is not receiving enough heat, which circulators or valves in the system must operate in order to deliver heat to the affected zone? If the zone is receiving too much heat, which pumps, valves, or check valves must operate in order to stop the delivery of heat?

Press the **Test** button on the control and follow the control through the test sequence as described in the Testing section. Pause the control as necessary to ensure that the correct device is operating as it should.

Sketch the piping of the system. This is a relatively simple step that tends to be overlooked; however, it can often save hours of time in troubleshooting a system. Note flow directions in the system paying close attention to the location of circulators, check valves, pressure bypass valves, and mixing valves. Ensure correct flow direction on all pumps. This is also a very useful step if additional assistance is required.

Document the control for future reference. Before making any adjustments to the control, note all of the items that the control is currently displaying. This includes items such as error messages, current temperatures and settings, and which devices should be operating as indicated by the LCD. This information is an essential step if additional assistance is required to diagnose the problem.

Isolate the problem between the control and the system. Now that the sequence of operation is known and the system is sketched, is the control operating the proper circulators and valves at the correct times? Is the control receiving the correct signals from the system as to when it should be operating? Are the proper items selected in the menus of the control for the device that is to be operated?

Test the contacts, voltages, and sensors. Using a multimeter, ensure that the control is receiving adequate voltage to the power terminals as noted in the technical data. Use the multimeter to determine if the internal contacts on the control are opening and closing correctly. Follow the instructions in the Testing the Wiring section on page 11 to simulate closed contacts on the terminal blocks as required. Test the sensors as described on page 15.

What to do if the building temperature is incorrect:

Underheating:

If the building is too cool during cold weather, this indicates that the upper portion of the programmed heating curve is too low, or that the supply water high limit (MIX MAX) has been reached. If the supply temperature is close to MIX MAX, then this setting must be increased to provide more heat (if possible without damaging floors). Otherwise increase the MIX DSGN temperature, which will increase the supply water temperature (by increasing the slope of the heating curve).

If the building is too cool in warm weather, increase the value of the ROOM setpoint in the Adjust menu. This will shift the heating curve up to provide higher water temperatures.

Overheating:

If the building is too warm during cold weather, decrease the value of the MIX DSGN setting in the Adjust menu. This will reduce the slope of the heating curve, providing less heat to the building at low outdoor temperatures.

If the building is too warm during warmer weather, reduce the value of the ROOM setpoint in the adjust menu. This will shift the heating curve downward to reduce water temperatures.

Error Messages

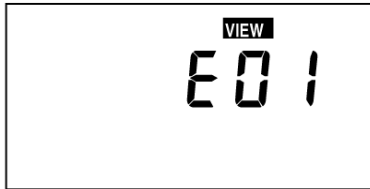
**E01**

The control was unable to read a piece of information from its EEPROM. This error can be caused by a noisy power source. The control will load the factory defaults and stop operation until the settings are verified.

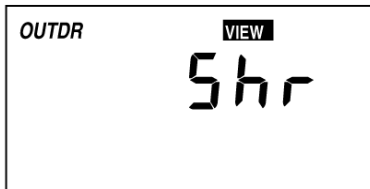
**Shr (OUTDR)**

The control is no longer able to read the Outdoor sensor due to a short circuit. In this case the control assumes an outdoor temperature of 32°F (0°C) and continues operation. Locate the problem as described in Section 5.7. To clear the error message from the control after the sensor has been repaired, press the **Item** button.

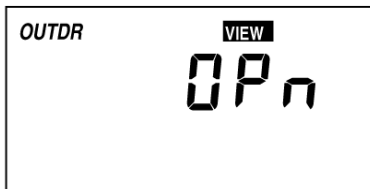
**OPn (OUTDR)**

The control is no longer able to read the Outdoor sensor due to an open circuit. In this case the control assumes an outdoor temperature of 32°F (0°C) and continues operation. Locate the problem as described in Section 5.7. To clear the error message from the control after the sensor has been repaired, press the **Item** button.

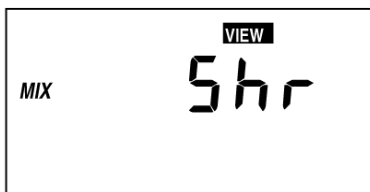
**Shr (MIX)**

The control is no longer able to read the Mixing Supply sensor due to a short circuit. In this case the control will operate the mixing valve at a fixed output. Locate the problem as described in Section 5.7. To clear the error message from the control after the sensor has been repaired, press the **Item** button.

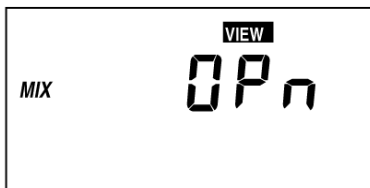
**OPn (MIX)**

The control is no longer able to read the Mixing Supply sensor due to an open circuit. In this case the control will operate the mixing valve at a fixed output. Locate the problem as described in Section 5.7. To clear the error message from the control after the sensor has been repaired, press the **Item** button.

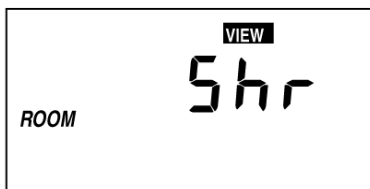
**Shr (ROOM)**

The control is no longer able to read the Indoor sensor due to a short circuit. The control will continue to operate as if there was nothing connected to the Indoor sensor input. Locate the problem as described in Section 5.7. To clear the error message from the control after the sensor has been repaired, press the **Item** button.

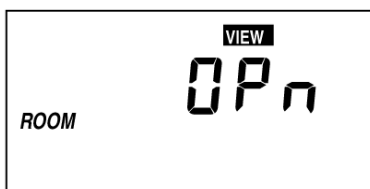
**OPn (ROOM)**

The control is no longer able to read the Indoor sensor due to an open circuit. The control will continue to operate as if there was nothing connected to the Indoor sensor input. Locate the problem as described in Section 5.7. To clear the error message from the control after the sensor has been repaired, press the **Item** button.

Mechanical

- P1 = Boiler Circulator Pump
- P2 = Mixing System Circulator Pump
- S1 = Mix Supply Sensor
- S2 = Outdoor Sensor
- S3 = Indoor Sensor (optional)

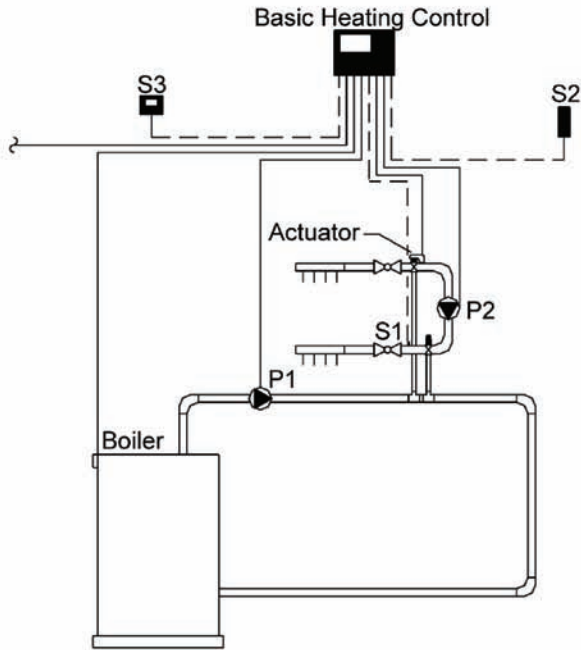

Mechanical

- P1 = Boiler Circulator Pump
- P2 = Mixing System Circulator Pump
- S1 = Mix Supply Sensor
- S2 = Outdoor Sensor
- S3 = Indoor Sensor (optional)

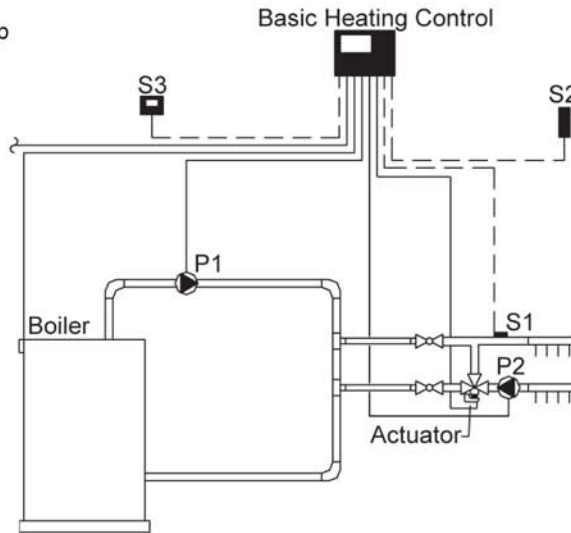

Electrical

- P1 = Boiler Circulator Pump
- P2 = Mixing System Circulator Pump
- S1 = Mix Supply Sensor
- S2 = Outdoor Sensor
- S3 = Indoor Sensor (optional)

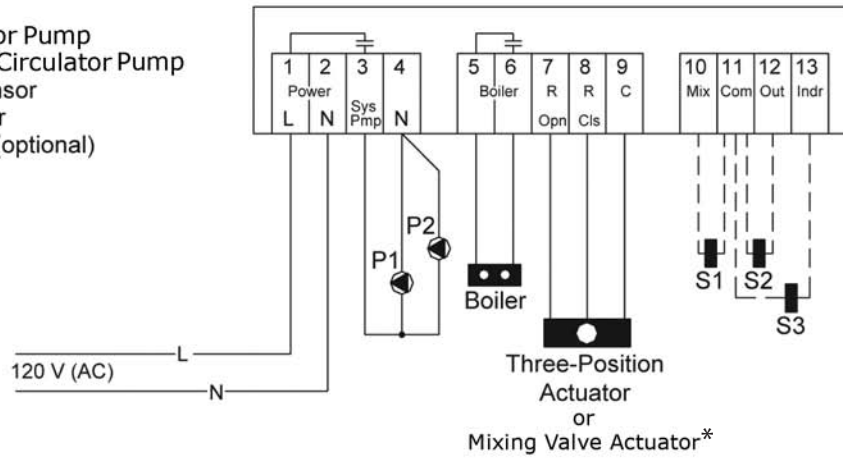

Note: This is only a conceptual drawing. The designer must determine whether this application will work in his system and must ensure compliance with code requirements. Necessary auxiliary equipment, isolation relays (for loads greater than the specified internal relay ratings), and other safety and limit devices must be added.

* Three Position Actuator: White wire common, green wire open, brown wire close.

Mixing Valve Actuator: Blue wire common, brown wire clockwise rotation, black wire counter-clockwise rotation

Technical Data

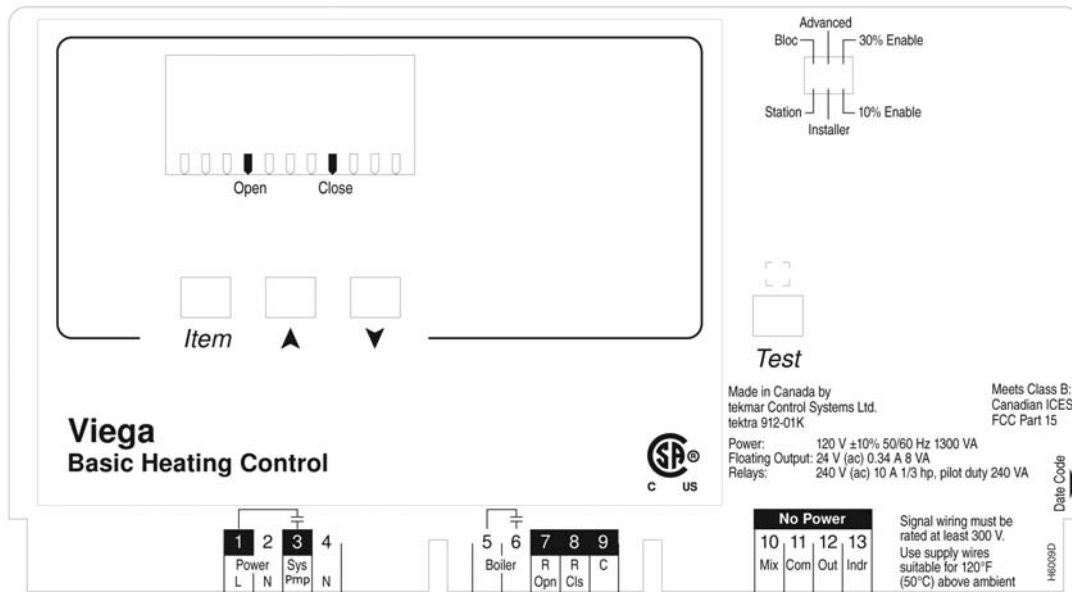

Control	Microprocessor PID control; this is not a safety (limit) control
Packaged Weight	3.1 lbs. (1420 g) Enclosure black PVC plastic
Dimensions	6-5/8" H x 7-9/16" W x 2-13/16" D (170 x 193 x 72 mm)
Approvals	CSA C US, meets ICES & FCC regulations for EMI/RFI
Ambient Conditions	Indoor use only, 32 to 102°F (0 to 39°C), <90% RH non-condensing
Power Supply	120 VAC +/- 10% 50/60 Hz 1300 VA
Floating Output	24 VAC 0.34 A 8 VA
Relays	240 VAC 10 A 1/3 hp, pilot duty 240 VA
Sensors	NTC thermistor

Sensor Resistances

Temperature		Resistance	Temperature		Resistance	Temperature		Resistance	Temperature		Resistance
°F	°C	Ω	°F	°C	Ω	°F	°C	Ω	°F	°C	Ω
-50	-46	490,813	20	-7	46,218	90	32	7,334	160	71	1,689
-45	-43	405,710	25	-4	39,913	95	35	6,532	165	74	1,538
-40	-40	336,606	30	-1	34,558	100	38	5,828	170	77	1,403
-35	-37	280,279	35	2	29,996	105	41	5,210	175	79	1,281
-30	-34	234,196	40	4	26,099	110	43	4,665	180	82	1,172
-25	-32	196,358	45	7	22,763	115	46	4,184	185	85	1,073
-20	-29	165,180	50	10	19,900	120	49	3,760	190	88	983
-15	-26	139,402	55	13	17,436	125	52	3,383	195	91	903
-10	-23	118,018	60	16	15,311	130	54	3,050	200	93	829
-5	-21	100,221	65	18	13,474	135	57	2,754	205	96	763
0	-18	85,362	70	21	11,883	140	60	2,490	210	99	703
5	-15	72,918	75	24	10,501	145	63	2,255	215	102	648
10	-12	62,465	80	27	9,299	150	66	2,045	220	104	598
15	-9	53,658	85	29	8,250	155	68	1,857	225	107	553



Basic Heating Control Installation and Operation Manual

ProPress® System
Flameless copper
press technology.



ProPress® System
Flameless copper fire safety
press technology.



ProPressG™ System
Flameless copper fuel gas
press technology.



PureFlow® System
Flexible PEX tubing
plumbing technology.



ProRadiant™ Systems
Comfortable, efficient
heating technology.

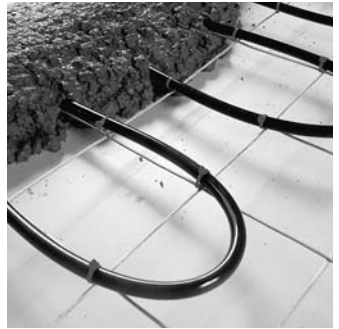

S-no-Ice® System
Snow and ice
melting technology.

The global leader
in plumbing and
heating systems.

Rely on Viega for the most complete line of high tech/high quality plumbing, heating, and snow melting systems...plus the most comprehensive customer support in the industry.

Viega
301 N. Main
Wichita, KS 67202
Phone: 1-877-843-4262
1-800-976-9819
Fax: 1-800-976-9817
www.viega.com