

REVISIONS			
REV	DESCRIPTION	DATE	APPROVED
A	Released	5/12/2009	

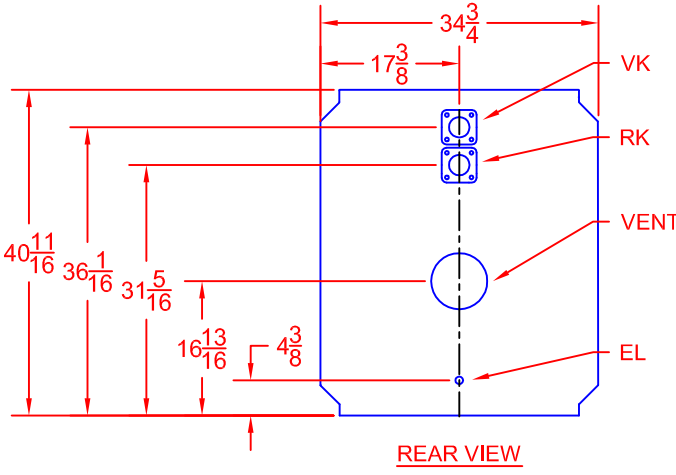
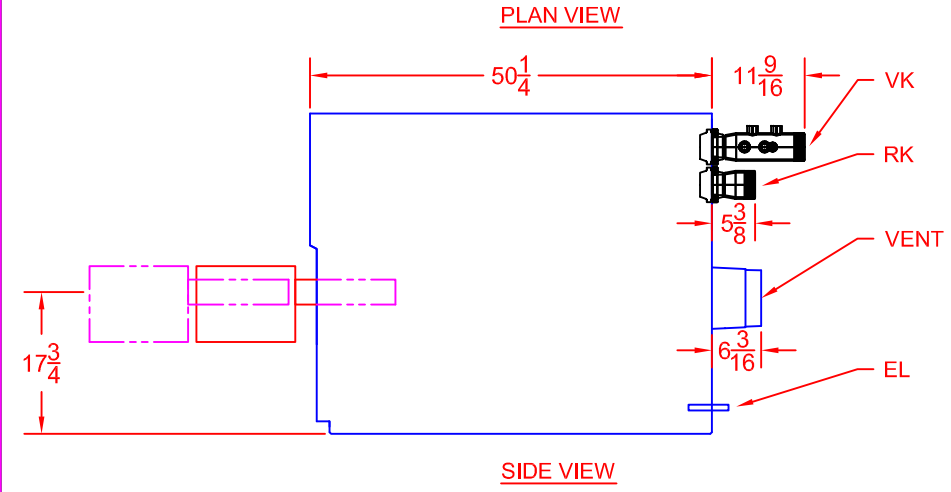

G315-7 (580 MBTH)									
Gas									
Riello	A	B	Power Flame	A	B	Beckett	A	B	
40G900	15 1/4	20	J15A-10	22 1/4	25 1/4	CG10.4S	21	25 1/2	
			C1-G-10	30 7/8	34 7/8				

Legend		
ABR.	Name	Size
VK	Supply	3
RK	Return	3
EL	Boiler Drain	3/4

NOTE 1. 'A' Dimension is to the back of the burner.
 'B' Dimension is the extraction dimension.

2. All dimensions are in inches.

3. Manifold provided, field assembly required.

4. Burner shipped separately; field assembly required.

Bosch Thermotechnology Corp.
 50 Wentworth Ave.
 Londonderry, NH 03053
 Phone: 603-552-1100

Tolerance

Fraction= $\pm\frac{1}{4}$ "
 x.x= ± 0.030
 x.xx= ± 0.015
 x.xxx= ± 0.005

(UNLESS OTHERWISE NOTED)

This drawing is the exclusive property of Bosch Thermotechnology Corporation, it may not be reproduced or given to third parties.

Drawn By:
 M SPIRIDIGLOZZI

Approved By:
 J MILLS

Buderus
 Bosch Group

Bosch Thermotechnology Corp.

DESCRIPTION
G315-7 BOILER BURNER SPECIFICATION

SIZE A	SCALE 1/2" = 1'	PART NO BTC 411006103	REV. A
------------------	--------------------	---------------------------------	------------------

DATE 4/15/2009

SHEET 1 of 1

4

3

2

1

D

D

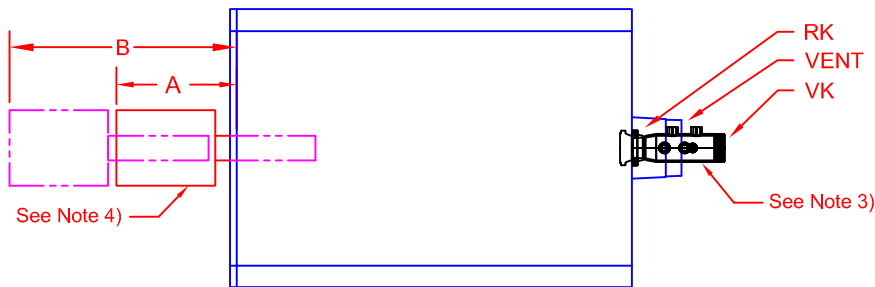

PLAN VIEW

REVISIONS			
REV	DESCRIPTION	DATE	APPROVED
A	Released	5/12/2009	

C

C

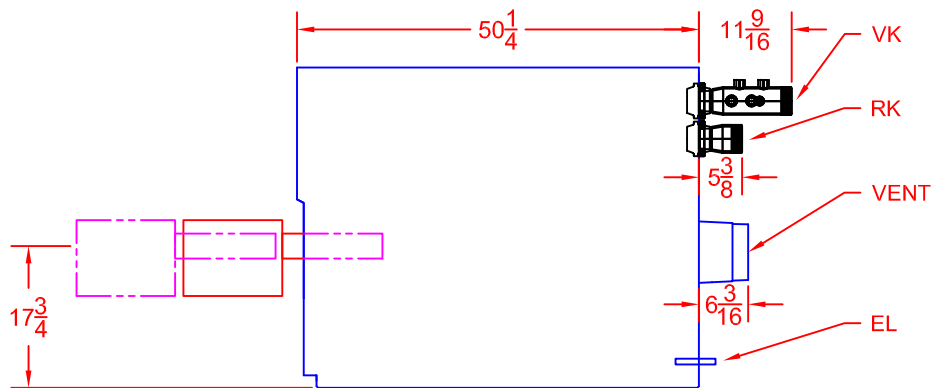

SIDE VIEW

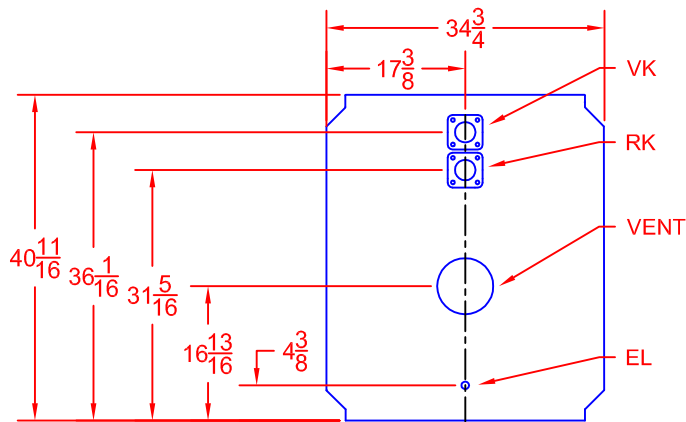

REAR VIEW

B

B

G315-7 (580 MBTH)								
Oil								
Riello	A	B	Power Flame	A	B	Beckett	A	B
F15	11 3/4	21 3/4	C1-0	30 7/8	34 1/8	CF800	11 1/2	16

Legend		
ABR.	Name	Size
VK	Supply	3
RK	Return	3
EL	Boiler Drain	3/4

NOTE 1. 'A' Dimension is to the back of the burner.
 'B' Dimension is the extraction dimension.

- 2. All dimensions are in inches.
- 3. Manifold provided, field assembly required.
- 4. Burner shipped separately; field assembly required.

Bosch Thermotechnology Corp.
 50 Wentworth Ave.
 Londonderry, NH 03053
 Phone: 603-552-1100

Tolerance
 Fraction= $\pm\frac{1}{4}$ "
 x.x= ± 0.030
 x.xx= ± 0.015
 x.xxx= ± 0.005
 (UNLESS OTHERWISE NOTED)

This drawing is the exclusive property of Bosch Thermotechnology Corporation, it may not be reproduced or given to third parties.

Drawn By:
 M SPIRIDIGLOZZI
 Approved By:
 J MILLS



Bosch Thermotechnology Corp.

DESCRIPTION G315-7 BOILER BURNER SPECIFICATION			
SIZE A	SCALE 1/2" = 1'	PART NO BTC 411006103	REV. A
DATE 4/15/2009		SHEET 1 of 1	

4

3

2

1

A

A

4

3

2

1

D

D

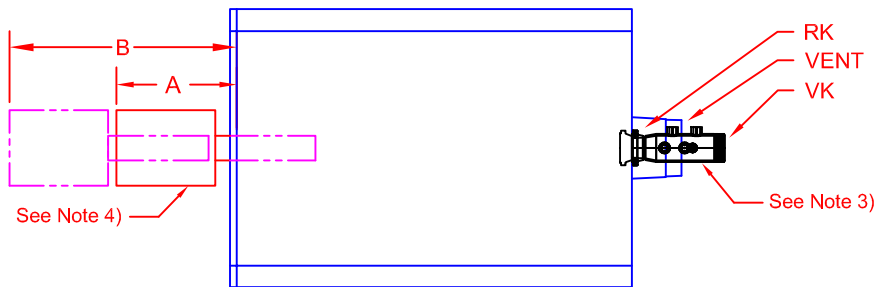

PLAN VIEW

REVISIONS			
REV	DESCRIPTION	DATE	APPROVED
A	Released	5/12/2009	

C

C

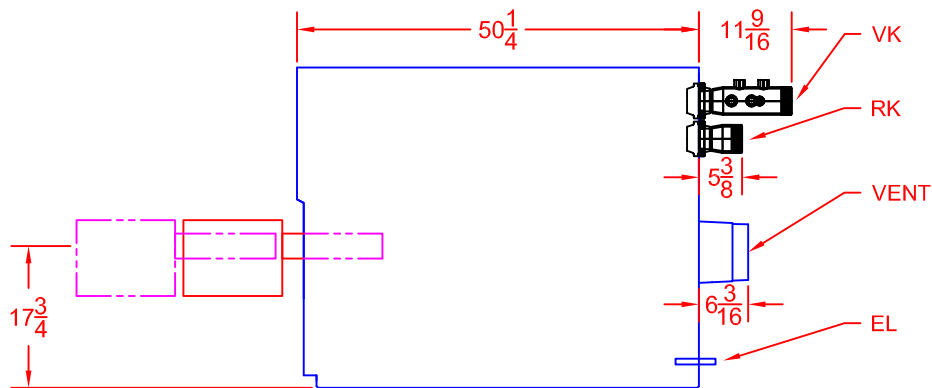

SIDE VIEW

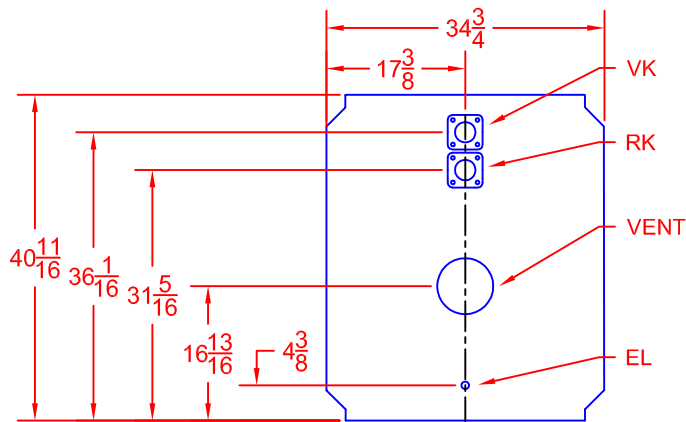

REAR VIEW

B

B

G315-7 (580 MBTH)		
Combination		
Power Flame	A	B
C1-GO-10	30 7/8	34 7/8

Legend		
ABR.	Name	Size
VK	Supply	3
RK	Return	3
EL	Boiler Drain	3/4

NOTE 1. 'A' Dimension is to the back of the burner.
 'B' Dimension is the extraction dimension.

- 2. All dimensions are in inches.
- 3. Manifold provided, field assembly required.
- 4. Burner shipped separately; field assembly required.

Bosch Thermotechnology Corp.
 50 Wentworth Ave.
 Londonderry, NH 03053
 Phone: 603-552-1100

Tolerance
 Fraction= $\pm\frac{1}{4}$ "
 x.x= ± 0.030
 x.xx= ± 0.015
 x.xxx= ± 0.005
 (UNLESS OTHERWISE NOTED)

This drawing is the exclusive property of Bosch Thermotechnology Corporation, it may not be reproduced or given to third parties.

Drawn By:
 M SPIRIDIGLOZZI
 Approved By:
 J MILLS



Bosch Thermotechnology Corp.

DESCRIPTION
G315-7 BOILER BURNER SPECIFICATION

SIZE	SCALE	PART NO	REV.
A	1/2" = 1'	BTC 411006103	A
DATE 4/15/2009		SHEET 1 of 1	

4

3

2

1

A

A

4 3 2 1

REVISIONS			
REV	DESCRIPTION	DATE	APPROVED
A	RELEASED	6/12/2009	

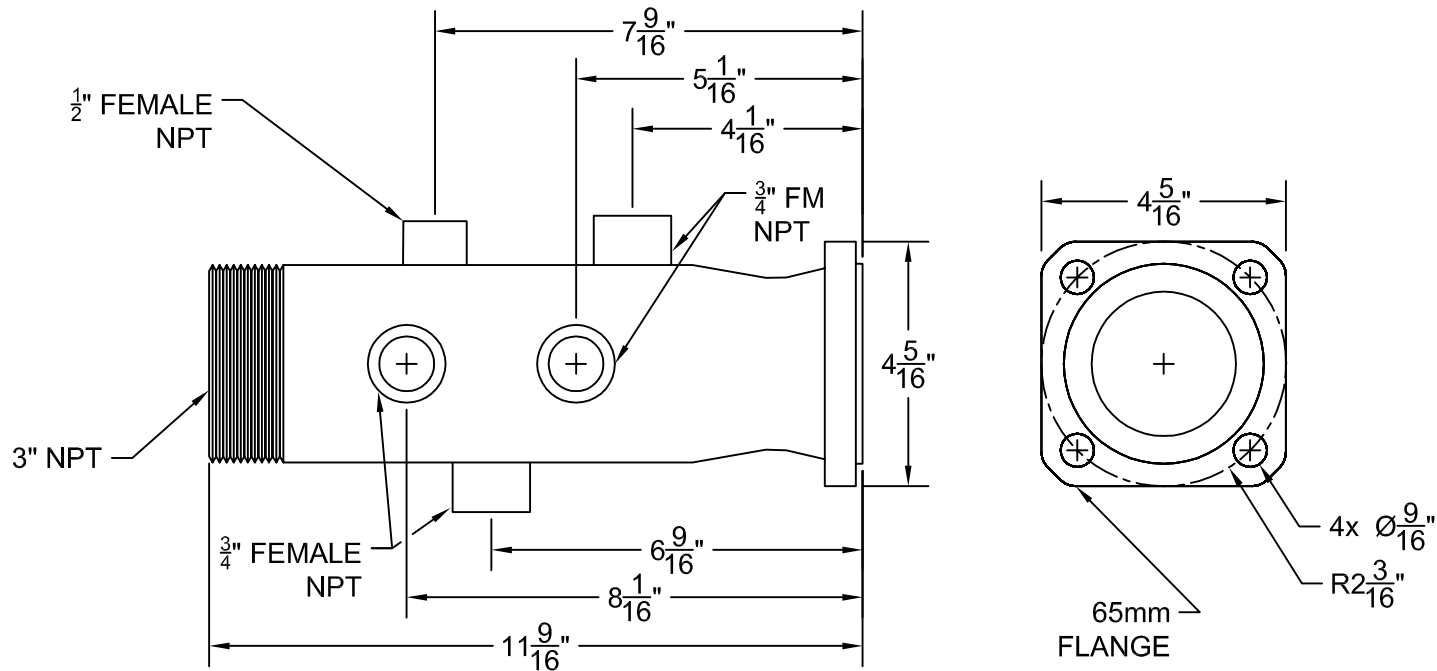

NOTE
 1. All dimensions are in inches.
 2. All pipe sizes are NPT.

Bosch Thermotechnology Corp.
 50 Wentworth Ave.
 Londonderry, NH 03053
 Phone: 603-552-1100

Tolerance
 Fraction = ± 1/4"
 x.x = ± 0.030
 x.xx = ± 0.015
 x.xxx = ± 0.005
 (UNLESS OTHERWISE NOTED)

This drawing is the exclusive property of Bosch Thermotechnology Corporation, it may not be reproduced or given to third parties.

Drawn By:
 M SPIRIDIGLOZZI

Approved By:
 J MILLS

Buderus		Bosch Thermotechnology Corp.	
Bosch Group		DESCRIPTION G315 SUPPLY MANIFOLD SPECIFICATION	
SIZE A	SCALE NTS	PART NO. BTC 411006111	REV. A
DATE 6/9/2009		SHEET 1 of 2	

4 3 2 1

4

3

2

1

REVISIONS

REV	DESCRIPTION	DATE	APPROVED
A	RELEASED	6/12/2009	

D

D

C

C

B

B

A

A

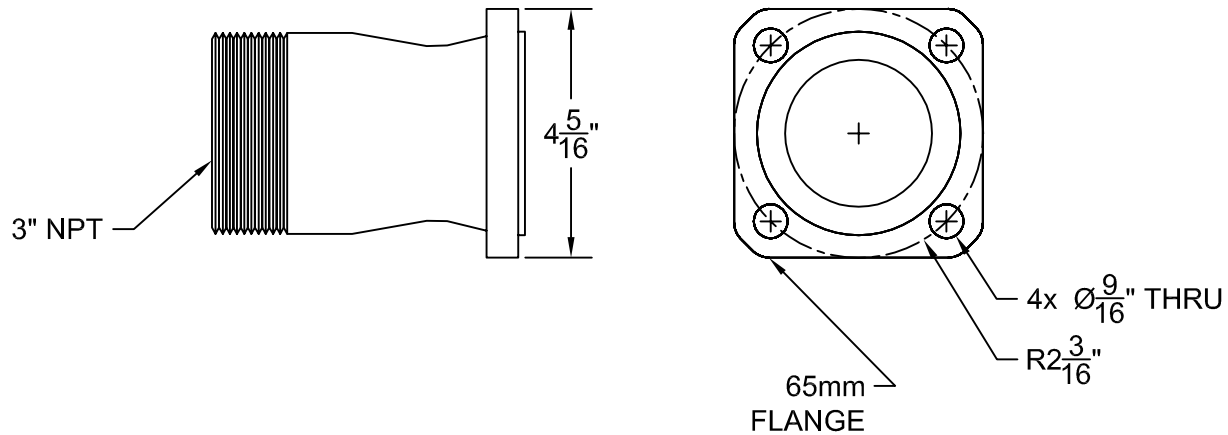

NOTE

- All dimensions are in inches.
- All pipe sizes are NPT.

Bosch Thermotechnology Corp.
 50 Wentworth Ave.
 Londonderry, NH 03053
 Phone: 603-552-1100

Tolerance

Fraction = $\pm \frac{1}{4}$ "
 x.x = ± 0.030
 x.xx = ± 0.015
 x.xxx = ± 0.005

(UNLESS OTHERWISE NOTED)

This drawing is the exclusive property of Bosch Thermotechnology Corporation, it may not be reproduced or given to third parties.

Drawn By:
 M SPIRIDIGLOZZI

Approved By:
 J MILLS

Buderus

Bosch Group

Bosch Thermotechnology Corp.

DESCRIPTION
G315 RETURN MANIFOLD SPECIFICATION

SIZE A	SCALE NTS	PART NO. BTC 411006111	REV. A
------------------	--------------	---------------------------	-----------

DATE 6/9/2009

SHEET 1 of 2

4

3

2

1