



CANADA'S FINEST STOVES

PLEASE SAVE THESE INSTRUCTIONS

**TESTED and LISTED to CAN/ULC
S627 AND UL 1482
Meets the Environmental Protection
Agency's
July 1990 Particulate Emission
Standards**

INSTALLATION & OPERATION GUIDE

Design - D

Model

FUSION

SAFETY NOTICE

**If this stove is not properly installed,
a house fire may result. For your
safety, follow the installation
instructions. Contact local building
or fire officials about restrictions
and installation inspection
requirements in you area.**

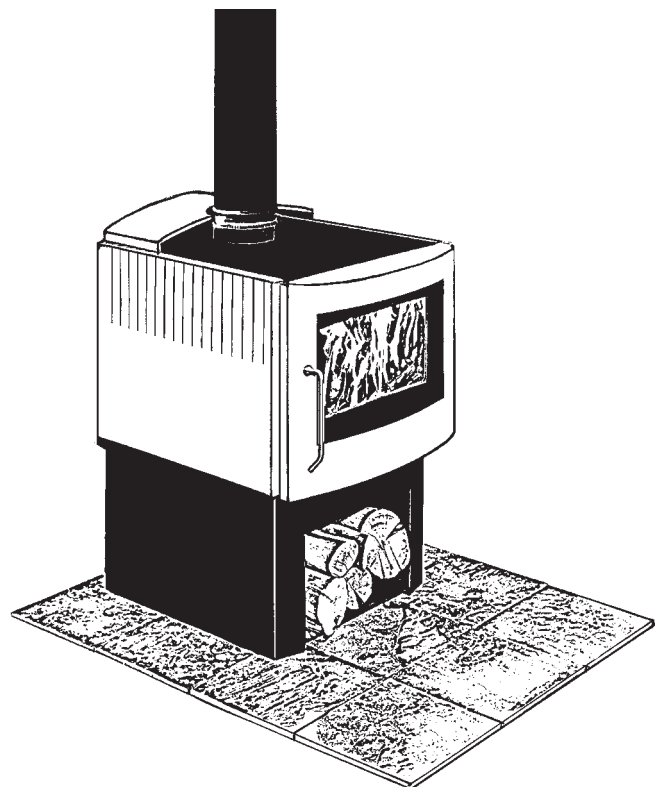

Contents

Safety and Maintenance	3
Creosote	4
Formation and Need for Removal	4
Chimney Fires	4
In Case of a Chimney Fire	4
Avoiding a Chimney Fire	4
Stove Dimensions	5
Minimum Clearance to Combustibles	5
Mobile Home Installation	6
Clearances	6
Procedure:	6
Listed Chimney and Chimney Connector	7
Residential Installation	8
Clearances	8
Chimney and Connector	8
Double-Wall Connector	8
Single-Wall Connector	8
Procedure	8
Floor Protector	9
Combustion Air	9
Operation	10
Wood Selection	10
How to Test Your Wood	10
Lighting for the First Time	10
Lighting a Fire	10
Normal Operation	10
Restarting After Extended or Overnight Burns	11
More Wood, More Heat	11
Proper Draft	11
Ash Removal	11
Disposal of Ashes	11
Baffle Removal	11
Removal	11
Optional Blower	12
Blower Installation	12
Blower Operation	12
Appendix A	13
Troubleshooting	13
Replacement Parts	14
Label	15

PLEASE SAVE THESE INSTRUCTIONS

NOTE: WE STRONGLY RECOMMEND THAT SMOKE DETECTORS BE INSTALLED.

If smoke detectors have been previously installed, you may notice that they are operating more frequently. This may be due to curing of stove paint or fumes caused by accidentally leaving the fire door open. Do not disconnect the detectors. If necessary, relocate them to reduce their sensitivity.

SAFETY NOTICE: If this stove is not properly installed, a house fire may result. For your safety, follow the installation instructions. Contact local building or fire officials about restrictions and installation inspection requirements in you area.

Please read this entire manual before you install and use your new room heater. Failure to follow instructions may result in property damage, bodily injury, or even death.

Safety and Maintenance

1. Burn wood only, dry and well seasoned. The denser or heavier the wood when dry, the greater its heat value. This is why hardwoods are generally preferred. Green or wet wood will cause a rapid buildup of creosote. If you feel it is necessary to burn wet or unseasoned wood, do so only with the air inlet set open enough to maintain a good strong fire and fairly high chimney temperatures. Do not attempt to burn overnight using green wood or wet wood. Wet wood can cause up to 25% drop in heater output, as well as contributing significantly to creosote buildup.
WARNING: Never use chemicals or any other volatile liquid to start a fire. Do not burn garbage, or flammable fluids such as gasoline, naphtha, or engine oil. We strongly recommend that smoke detectors be installed.
2. Remove ashes frequently. Embers can roll out the door and create a fire hazard. Maintain a 1" minimum ash base.
3. If glass becomes darkened through slow burning or poor wood, it can readily be cleaned with fireplace glass cleaner when stove is cold. Never scrape with an object that might scratch the glass. The type and amount of deposit on the glass is a good indication of the flue pipe and chimney buildup. A light brown dusty deposit that is easily wiped off usually indicates good combustion and dry, well-seasoned wood and therefore relatively clean pipes and chimney. On the other hand, a black greasy deposit that is difficult to remove is a result of wet and green wood and too slow a burning rate. This heavy deposit is building up at least as quickly in the chimney.
WARNING: ONLY USE MATERIALS SUPPLIED BY MANUFACTURER WHEN DOING MAINTENANCE OR REPLACEMENTS.
4. **DOOR GASKETS** - The gasket used by Pacific Energy (7/8" medium density fiberglass rope) requires only light pressure to seal. This will prolong seal life. It is important that the door seal be maintained in good condition. Periodically inspect seals and replace if necessary. Follow instructions included in the DR31.WDGKIT kit obtainable from your nearest Pacific Energy dealer.
5. **DOOR GLASS** - Do not slam loading door or otherwise impact glass. When closing door, make sure that no logs protrude to impact the glass. If the glass gets cracked or broken, **it must be replaced before using the stove.** Replacement glass can be obtained from your dealer. Use 8-13/16" x 15-1/4" x 5 mm. Ceramic glass only. **Do not substitute with any other type.**
To remove broken glass, undo the four retaining screws and remove clamps and frame, noting position for re-assembly. Remove all particles of glass. Be careful as they are very sharp. Install new glass complete with gasket. Replace frame, clamps and screws.
CAUTION:
 - do not overtighten, tighten screws very carefully
 - do not clean glass when hot
 - do not use abrasive cleaners on glass
6. The area where boost combustion air enters the firebox must be kept clear of excessive ash buildup which will block air flow. This area is at the front of the firebox.
7. Do not store wood within heater installation clearances, or within the space required for fuel loading and ash removal. Keep the area around the heater clean and free of loose combustibles, furniture, newspapers, etc.
8. If gold door requires cleaning, use mild soap and water only. **Use of abrasive cleaners will void warranty.**
9. Establish a routine for the fuel, woodburning and firing technique. Check daily for creosote buildup until experience shows how often you need to clean to be safe.
10. Be aware that the hotter the fire, the less creosote is deposited. Weekly cleaning may be necessary in mild weather, even though monthly cleaning is usually enough in the coldest months when burning rates are higher.
11. Instruct all members of your family on the safe operation of the heater. Ensure they have enough knowledge of the entire system if they are expected to operate it. Stress the section on chimney fires and the importance of following the steps outlined "In Case of Chimney Fire".

Creosote

Formation and Need for Removal

When wood is burned slowly, it produces tar and other organic vapours, which combine with expelled moisture to form creosote. The creosote vapours condense in the relatively cool chimney flue of a slow burning fire. As a result, creosote residue accumulates on the flue lining. When ignited, this creosote makes an extremely hot fire. The chimney connector and chimney should be inspected periodically (at least once every two months) during the heating season to determine if a creosote buildup has occurred. If creosote has accumulated (3 mm. or more), it should be removed to reduce the risk of a chimney fire.

1. Highest smoke densities occur when a large amount of wood is added to a bed of hot coals and the air inlet is closed. The heated wood generates smoke, but without ample air, the smoke cannot burn. Smoke-free, clean burning requires small fuel loads, two or three logs at a time or 1/4 to 1/2 of fuel load and leaving the air inlet relatively wide open, especially during the first 10 to 30 minutes after each loading, when most of the smoke generating reactions are occurring. After 30 minutes or so, the air inlet can be turned down substantially without excessive smoke generation. Wood coals create very little creosote-producing smoke.
2. The cooler the surface over which the wood smoke is passing, the more creosote will be condensed. Wet or green wood contributes significantly to creosote formation as the excess moisture that is boiled off cools the fire, making it difficult for the tars and gases to ignite, thus creating dense smoke and poor combustion. This moisture-laden smoke cools the chimney, compounding the problem by offering the smoke the ideal place to condense.
In summary, a certain amount of creosote is inevitable and must be lived with. Regular inspection and cleaning is the solution. The use of dry, seasoned wood and ample combustion air will help to minimize the buildup.

Chimney Fires

The result of excessive creosote buildup is a chimney fire. Chimney fires are dangerous. Chimney inside temperatures can exceed 2000° F. This causes much higher than normal temperatures in the chimney and on its exterior surfaces. Thus ignition of nearby or touching combustible material is more likely during a chimney fire. Proper clearances are critical during such a fire.

Chimney fires are easy to detect; they usually involve one or more of the following:

- Flames and sparks shooting out of the top of the chimney
- A roaring sound
- Vibration of the chimney

In Case of a Chimney Fire

1. Prepare to evacuate to ensure everyone's safety. Have a well understood plan of action for evacuation. Have a place outside where everyone is to meet.
2. Close air inlet on stove.
3. Call local fire department. Have a fire extinguisher handy. Contact your local municipal or provincial fire authority for further information on how to handle a chimney fire. It is most important that you have a clearly understood plan on how to handle a chimney fire.
4. After the chimney fire is out, the chimney must be cleaned and checked for stress and cracks before starting another fire. Also check combustibles around the chimney and the roof.
- The services of a competent or certified installer, (certified by the Wood Energy Technical Training program (WETT) - in Canada, Hearth Education Foundation (HEARTH) - in U.S.A.,) are strongly recommended.

Avoiding a Chimney Fire

There are two ways to avoid chimney fires:

1. Do not let creosote build up to a point where a big chimney fire is possible.
2. Do not have fires in the heater that may ignite chimney fires. These are hot fires, such as when burning household trash, cardboard, Christmas tree limbs, or even ordinary fuel wood; (e.g.. with a full load on a hot bed of coals and with the air inlet excessively open.)

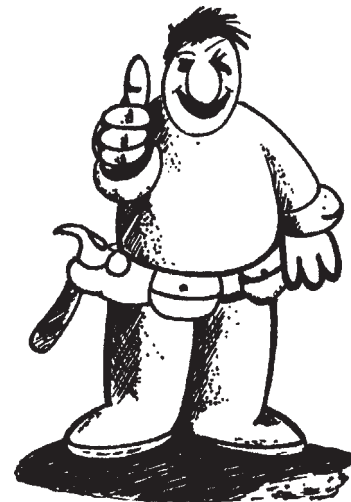

Stove Dimensions

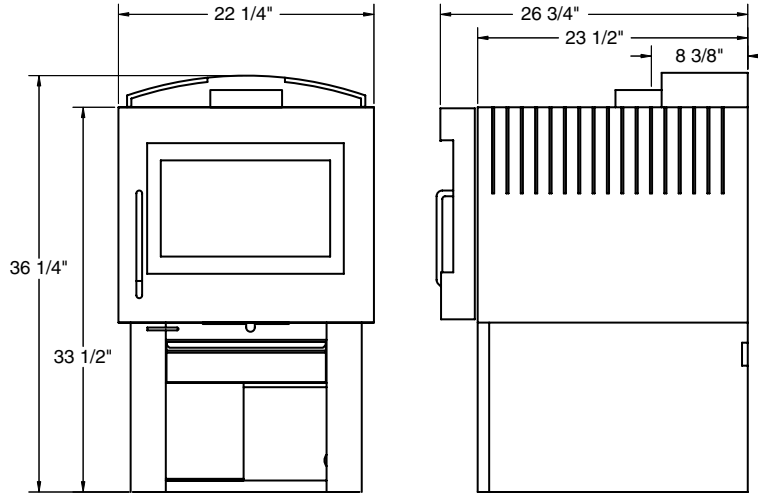

FIG. #1

Minimum Clearance to Combustibles

Single Wall Connector - Residential



Double Wall Connector - Residential

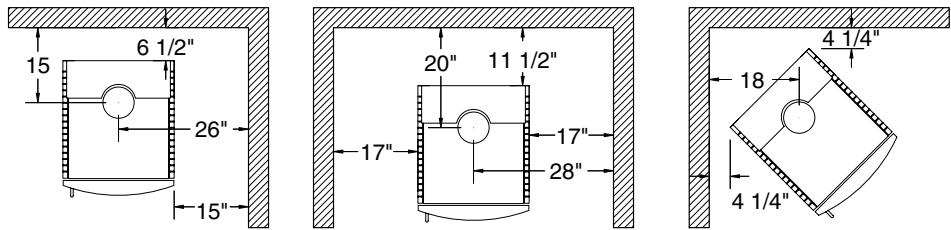

Alcove: Min. Height 7 1/2'
Max. Depth 4'

Double Wall Connector - Mobile Home



Mobile Home Installation

Warning: Under no circumstances is this heater to be installed in a makeshift or "temporary" manner. It may be fired only after the following conditions have been met.

- **DO NOT CONNECT THIS UNIT TO A CHIMNEY FLUE SERVING ANOTHER APPLIANCE.**
- **DO NOT INSTALL IN A SLEEPING ROOM.**
- Outside air supply must be used for Mobile Home installations see Figure #2, Page 7.
- The services of a competent or certified installer, (certified by the Wood Energy Technical Training program (WETT) - in Canada, Hearth Education Foundation (HEARTH) - in U.S.A.,) are strongly recommended.

Clearances

This heater must be installed with listed double-wall connector and compatible chimney system listed on page 7. Clearances to combustible surfaces and materials are shown below in Figure #1, page 5 and Figure #2, page 7. Clearances may be reduced with various heat insulating materials. Consult local fire codes and authorities for approval.

NOTE: Longer chimney lengths and different pitch flashings may be used. All other parts listed must be installed (see Figure #2, Page 7). Install all components to the connector or chimney manufacturer's installation requirements. Consult your chimney supplier for installation advice.

Procedure:

CAUTION: THE STRUCTURAL INTEGRITY OF THE MOBILE HOME FLOOR, WALL AND CEILING/ROOF MUST BE MAINTAINED.

Note: See "Combustion Air" section on page 9.

1. Position stove and floor protection with hole for combustion air in accordance with the clearances as stated on the label and in Figure #1.
2. Mark the position for the hole in the ceiling and roof by using a string and plumb-bob.
3. Check that the intended location will not interfere with floor joists, ceiling joists or rafters before proceeding further.
4. Cut a hole in the ceiling and roof to suit the chimney system and frame in the sides. The chimney support is mounted to the framing.
5. Assemble chimney sections so the finished length is resting on the support and protruding through the roof. Avoid having joints between ceiling and roof. Install radiation shield. Assemble flashing and storm collar and be sure to maintain the vapour barrier at this point. (Seal securely.) Attach rain cap and check flashing for leaks.
6. Install connector as per manufacturer's instructions.
7. Attach stove to flooring using two 1/4" x 2" or longer lag screws.

FIG. #2

The chimney may incorporate an offset. To do this safely, all sections of listed connector, offset elbows and chimney section must be screwed together by at least three sheet metal screws per joint. The chimney must be suitably supported by the chimney manufacturer's listed offset support.

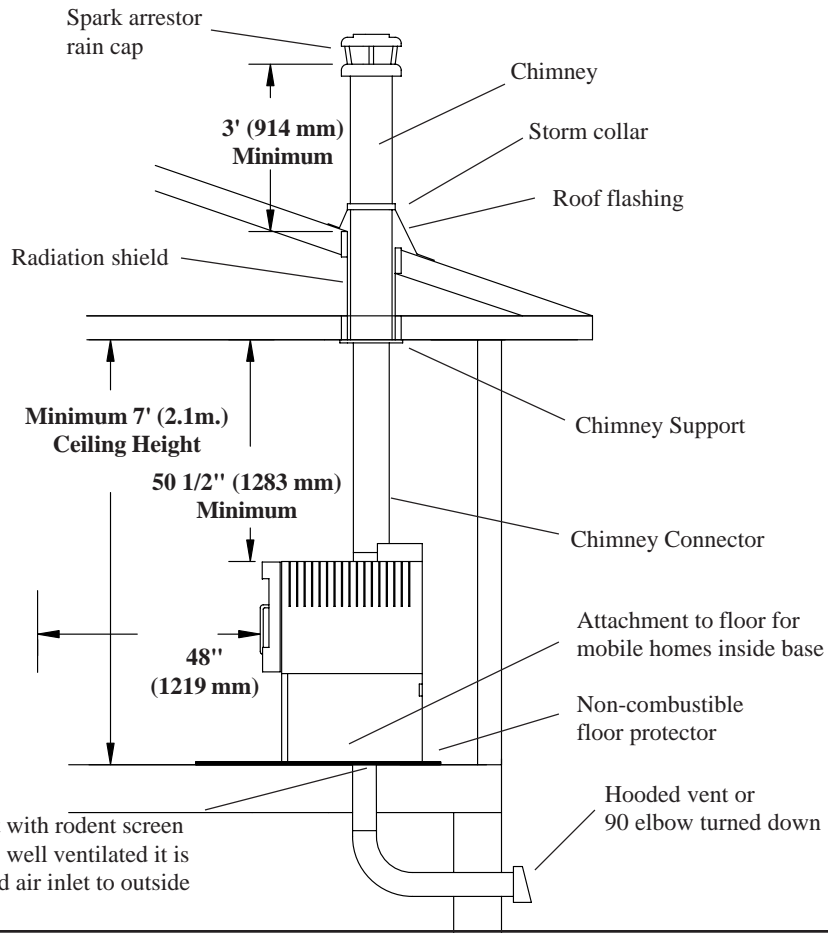

* 4" diameter air inlet with rodent screen
 * If the crawl space is well ventilated it is not necessary to extend air inlet to outside

Listed Chimney and Chimney Connector

This appliance, when installed in a Mobile Home, must be installed with:

A. One of the following 6" double-wall connector systems:

- | | |
|---------------------------------|---|
| 1. Security Model DL or DC | 5. Metal Fab Model DW |
| 2. Oliver MacLeod Model PV | 6. Ameri-Tec Model DBSP |
| 3. Energy Vent | 7. Industrial Chimney Model Excel Ultra-Black |
| 4. Selkirk Metalbestos Model DS | 8. Simpson Dura-Vent Model DVL |

B. As well as one of the following compatible chimney systems - All parts 6":

CANADA ONLY:	Security S2100	Pro-Jet H.T.3000	ICC Excel 2100	Selkirk Sentinal CF	Energy Vent Commander 5000					
Ceiling support	XSF	FCS	SF	CF-CSP	CH6LCS					
Rafter radiation shield		RRS								
3' Chimney length	XL3	SL3	L3	CF-36SL	CH636					
2' Chimney length	XL2	SL2	L2	CF-24	CH624					
Roof flashing	XFA	RF17	FA	CF-FRA	CH6TCF					
Storm collar	XSC	SC	SC	CF-SC	CH6SC					
Spark arrester rain cap	XCPE	RCSA	CPE	CF-SA,CT	CH6RC, SS					
USA ONLY:	Security S2100	Pro-Jet H.T.3000	Security ASHT	Pro-Jet HT3103	Metalbestos SSII	MetalFab 2100	Ameritech TEC HS	ICC Excel 103HT	Simpson Dura-Vent Dura/Plus	Simpson Dura-Vent Dura Tech
Ceiling support	XSF	FCS	SF	FCS	T-SFA	TGCSP	6PL-CS	RDS/SQS	SDP-SB	SDP-SB
Rafter radiation shield		RRS		RRS	T-JSMH	TGRS				
3' Chimney length	XL3	SL3	L3	SL3	T-36	TG3	HS 36	CL48	SDP-P	SDT-P
2' Chimney length	XL2	SL2	L2	SL2	T-24	TG2	HS 24	CL24	SDP-P	SDT-P
Roof flashing	XFA	RF17	FA	RF	T-SFA	TGF	8RFFU	VF	SDP-F	SDT-F
Storm collar	XSC	SC	SC	SC	T-SC	TGSC	PL-ASCG	SC	SDP-SC	SDT-SC
Spark arrester rain cap	XCPE	RCSA	CPE	RCSA	T-CT	TGC	6PL-MPC	RCS	SDP-C	SDT-C

Residential Installation

Warning: Under no circumstances is this heater to be installed in a makeshift or "temporary" manner. It may be fired only after the following conditions have been met.

- * DO NOT ATTEMPT TO CONNECT THIS HEATER TO ANY AIR DISTRIBUTION DUCT.
- * The services of competent installer are strongly recommended.
- * Outside combustion air or fresh air into the room may be required in your area, consult local building codes (see Combustion Air section).

- The services of a competent or certified installer, (certified by the Wood Energy Technical Training program (WETT) - in Canada, Hearth Education Foundation (HEARTH) - in U.S.A.,) are strongly recommended.

Clearances

1. This heater may be installed using a single-wall connector (smoke pipe) or listed double-wall connector (see Mobile Home installation).
2. Clearances to combustible surfaces and materials using single-wall connector are shown in Figure #1, page 5. Clearances may be reduced with various heat insulating materials. Consult local fire codes and authorities for approval.
3. Alternately, for close clearances, use a listed double-wall connector. See Figure #1, page 5.

Chimney and Connector

Connect to a listed chimney or a chimney suitable for use with solid fuel that is lined and in good condition and meets local building codes. The chimney flue size should be the same as the stove outlet for optimal performance. Reducing or increasing the flue size may adversely affect stove performance. Chimney flue exit is to be 3 feet (1 m.) above roof and two feet (0.6 m.) above highest projection within 10 feet (3 m.). The installation must meet all local codes. Do not connect this unit to a chimney flue serving another appliance. Minimum system height is 15 feet (4.6 m.) (measured from base of appliance).

Double-Wall Connector

- Use a listed double-wall connector.
- Install all components to the chimney connector manufacturer's installation requirements.

Single-Wall Connector

Smoke pipe must be:

- * as short and straight as possible, use six inch diameter, 24 gauge black pipe that is clean and in new condition.
- * secured at every joint and collar with 3 sheet metal screws.
- * installed with the crimped or male ends pointing down. This will carry any liquid creosote or condensation back into the stove.
- * The chimney connector shall not pass through an attic, roof space, closet or similar concealed space, floor, or ceiling. Where passage through a wall, or partition of combustible material is desired, the installation shall conform to CAN/CSA-B365, Installation Code for Solid-Fuel-Burning Appliances and Equipment.

Procedure

1. If a listed chimney and double-wall connector is to be connected to the stove, install all components to the chimney manufacturer's installation requirements. (Outside combustion air may be required, consult local building codes. See Combustion Air section.)
2. If it is desirable to use smoke pipe in conjunction with the insulated chimney, see step 4.
3. If a roof or ceiling support is used in the installation, you will find the chimney manufacturer's complete instructions packed with the roof support.
4. To start installing smoke pipe (chimney connector), slip crimped edge of the pipe inside the stove collar. Use holes provided in collar to secure pipe with two screws.
5. Install the remaining lengths of pipe one on top of the other to the finished height of the chimney connector and secure to each other.

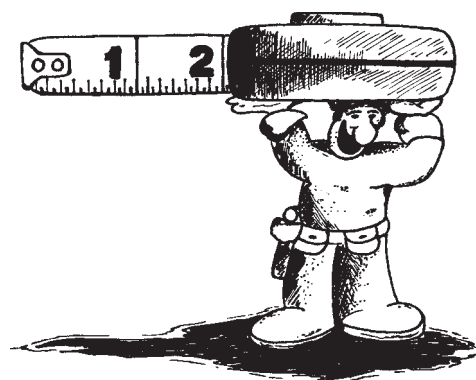

Floor Protector

Combustion Air

The stove may be installed on a combustible floor provided noncombustible ember protection is used.

This protection must extend as follows:

In Canada: 18" (457 mm) on the firing side and 8" (203 mm) to the other sides. See Figure #3, below.

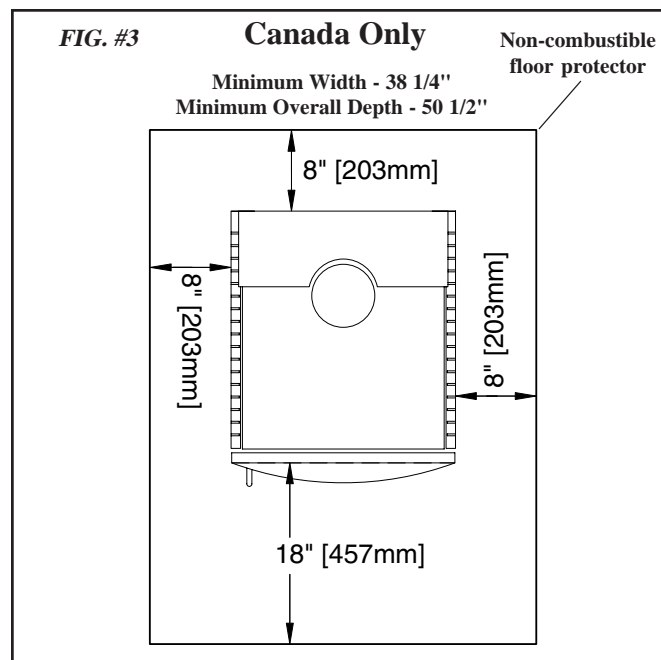

In USA: 16" (406 mm) to the front and 8" (203 mm) to the sides of the fuel loading door opening. See Figure #4, below. This protection is also required under the chimney connector and 2" (51 mm) beyond each side.

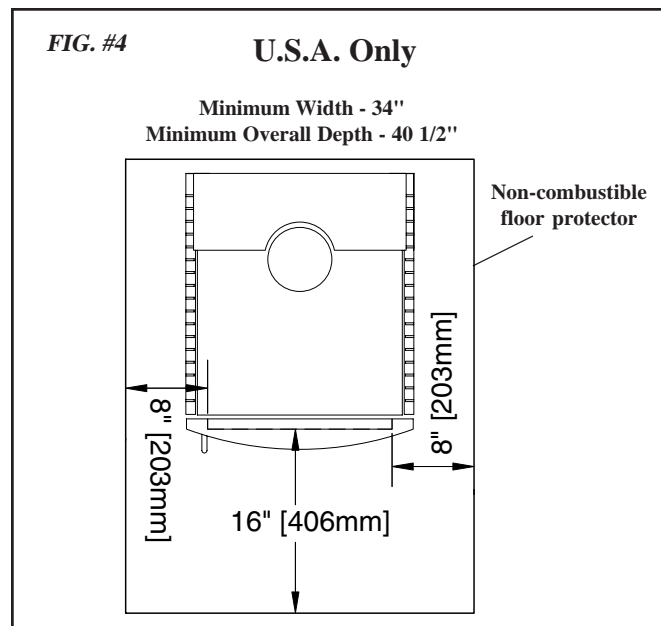

Intake or combustion air can be supplied to the stove in one of two ways. Consult your local building code or CAN/CSA-B365, Installation Code for Solid-Fuel-Burning Appliances and Equipment before proceeding.

1. **Outside air supply** - (Necessary for mobile home installation, optional for residential installation.) To draw outside air through the floor, leave the 4" knockout in the rear of the pedestal in place.

Cut or drill a 4" diameter or larger hole in the floor anywhere inside the perimeter of the pedestal base. Cover the hole with a 4" x 4" (100 mm x 100 mm) rodent screen and staple/nail in place.

This hole must get its air from a **ventilated** crawl space or be extended with duct to the outdoors (see Figure #2, Page 7). The use of outside combustion air for residential installation requires the unit to be secured to the structure to prevent dislodging of the air duct. Outside air may also be ducted from outside through the 4" diameter knockout hole in the rear of the pedestal enclosure.

Note: This unit is not designed to be operated with the firing door open. In addition to the obvious hazard of sparks landing on combustibles, an open fire door will cause the heater to draw air from the living space and possibly cause suffocation.

2. **Room air supply** - Remove the 4" plug from the rear of the pedestal enclosure. The stove will now draw its air from the room through this opening and into the firebox intake.

Note: The living space around the heater must be well ventilated with good air circulation. Anything that may cause a negative pressure can cause gases or fumes to be pulled into the living area. During extremely cold weather, and especially when burning at very slow rates, the upper parts of the exposed chimney may ice up, partially blocking the flue gases. If blockage occurs, flue gases may enter living space.

Operation

CAUTION: Never use gasoline, gasoline type lantern fuel, kerosene, charcoal lighter fluid or similar liquids to start or "freshen up" a fire in this heater. Keep all such liquids well away from the heater while it is in use.

CAUTION: Hot while in operation. Keep children, clothing and furniture away. Contact may cause skin burns.

Your PACIFIC ENERGY heater is designed for maximum overall efficiency at a moderate firing rate. Overfiring is hazardous and a waste of fuel. Too slow a burn contributes to creosote buildup and lowers combustion efficiency.

Wood Selection

This heater is designed to burn natural wood only. Higher efficiency and lower emissions generally result when burning air-dried seasoned hardwoods, as compared to softwoods or to green or freshly cut hardwoods.

Wood should be properly air dried (seasoned) for six months or more. Wet or undried wood will cause the fire to smoulder and produce large amounts of creosote. Wet wood also produces very little heat and tends to go out often.

DO NOT BURN :

- | | |
|--------------------|----------------|
| -Salt water wood * | -Treated wood |
| -Wet or green wood | -Coal/charcoal |
| -Garbage/Plastic * | -Solvents |

* **These materials contain chlorides which will rapidly destroy metal surfaces and void warranty.**

Do not burn anything but wood. Other fuels, eg. charcoal, can produce large amounts of carbon monoxide, a tasteless, odourless gas that can kill. Under no circumstances should you attempt to barbecue in this heater.

How to Test Your Wood

Add a large piece of wood to the stove when it has a good large bed of coals. It is dry if it is burning on more than one side within one minute. It is damp if it turns black and lights within three minutes. If it sizzles, hisses and blackens without igniting in five minutes it is soaked and should not be burnt.

Lighting for the First Time

Curing of the Paint Finish

To achieve the best finish, the paint on your stove must be baked on. When burning your stove for the first 2-3 times it is very important that the room be well ventilated. Open all windows and doors. Smoke and fumes caused by the curing process may cause discomfort to some individuals.

Lighting a Fire

WARNING: Never use chemicals or any other volatile liquid to start a fire.

1. Move air control lever to the left-most position (maximum firing rate) and open door.
2. Place crumpled newspaper in the centre of the heater and criss-cross with several pieces of dry kindling. Add a few small pieces of dry wood on top.
3. Ignite the paper and close the door.
4. After the fire has established itself, open the door and add a few small logs. Close door.
5. Begin normal operation after a good coal base exists and wood has charred.

Normal Operation

1. Set air control to a desired setting. If smoke pours down across the glass (waterfall effect) this indicates you have shut the control down too soon or you are using too low a setting. The wide range control panel makes finding the desired setting for your application easy. As every home's heating needs vary (ie. insulation, windows, climate, etc.) the proper setting can only be found by trial and error and should be noted for future burns.
2. To refuel, adjust air control to high, and give the fire time to brighten. Open the door slowly, this will prevent backpuffing.
3. Use wood of different shape, diameter and length (up to 18"). Load your wood endwise and try to place the logs so that the air can flow between them. Always use dry wood.
4. Do not load fuel to a height or in such a manner that would be hazardous when opening the door.
5. For extended or overnight burns, unsplit logs are preferred. Remember to char the wood completely on maximum setting before adjusting air control for overnight burn.

WARNING: Always keep loading door closed when burning. This heater is not designed for open door burning.

WARNING: No alteration or modification of the combustion air control assembly is permitted. Any tampering will void warranty and could be very hazardous.

WARNING: Do not use grates or andirons to elevate the fuel. Burn directly on the fire bricks. Replace broken or missing bricks. Failure to do so may create a hazardous condition.

Restarting After Extended or Overnight Burns

1. Open door and rake hot embers towards the front of the heater. Add a couple of dry, split logs on top of embers, close door.
2. Adjust air control to high (control lever to the left) and in just a few minutes, logs should begin burning.
3. After wood has charred, reset air control to desired setting.
4. To achieve maximum firing rate, set air control lever to the left-most position. Do not use this setting other than for starting or preheating fresh fuel loads.

DO NOT OVERFIRE THIS HEATER: Attempts to achieve heat output rates that exceed heater design specifications can result in permanent damage to the heater and chimney.

More Wood, More Heat

Seasoned wood has approximately 7500 BTU's per pound. If you put 10 pounds of wood in your stove for an eight hour burn the wood will be producing 9375 BTU's per hour. (7500 BTU x 10 lbs./8hrs.=9375 BTU's per hr.) If you put 20 lbs of wood in your stove for eight hour burn you will get 18,750 BTU's per hr. (7500 BTU x 20lbs./8hr.=18,750 BTU's per hr.). This is only an example and is based on 100% efficiency. In reality, your stove should perform in the 70% efficiency range.

Experience will give you the right settings for proper combustion and efficient burning. Remember the correct air inlet setting is affected by variables such as type of wood, outside temperature, chimney size and weather conditions. With practice, you will become proficient in operating your heater and will obtain the performance for which it was designed.

Proper Draft

1. Draft is the force which moves air from the appliance up through the chimney. The amount of draft in your chimney depends on the length of the chimney, local geography, nearby obstructions and other factors.
2. Too much draft may cause excessive temperatures in the appliance. An uncontrollable burn or a glowing red stove part or chimney indicates excessive draft.
3. Inadequate draft may cause backpuffing into the room and plugging of the chimney. Smoke leaking into the room through appliance and chimney connector joints indicates inadequate draft.

Ash Removal

Caution: Ashes are to be removed only when the heater is cold. Whenever ashes get 3 to 4 inches deep in your firebox, and when fire has burned down and cooled, remove excess ashes. Leave an ash bed approximately 1" (25 mm) deep on the firebox bottom to help maintain a hot charcoal bed.

Ash Cleanout system: The ash dump handle is located under the ash lip on the left hand side. To operate ash dump, pull handle out 1/2" and turn clockwise. This will unlock the ash dump and allow it to open. Hold handle open while pulling ashes into the opening. Avoid large embers as these still contain heat value. Release handle and push in to lock. Ensure ash dump door is properly engaged. Fill the cavity with the remaining ash level with the firebox floor. Lift and pull out ashpan and discard ashes into metal container. Replace ashpan and ensure it is seated properly.

Do not burn with ash dump door open. Doing so will create a hazardous condition. Always leave about 1" of ash when cleaning.

Disposal of Ashes

Ashes should be placed in a metal container with a tight fitting lid. The closed container of ashes should be placed on a non-combustible floor or on the ground, well away from all combustible materials, pending final disposal. If the ashes are disposed of by burial in soil or otherwise locally dispersed, they should be retained in closed container until all cinders have thoroughly cooled. Other waste should not be placed in this container.

Baffle Removal

Chimney connector pipe should be disconnected from stove to clean and inspect. Only if this is not possible should you remove baffle assembly.

DO NOT OPERATE WITH BAFFLE ASSEMBLY OR INSULATION REMOVED.

Removal

Remove retaining pin at the back top of the firebox, just under the baffle. Lift baffle up and pull forward to disconnect from the supply tube. Tilt baffle sideways to drop down and remove from firebox. Inspect gasket between baffle and supply tube. If necessary, replace with gasket #139.5 available from your Pacific Energy dealer. Re-install baffle assembly in reverse order. The two side pieces of insulation must be tight against the siderails.

Optional Blower

The optional blower kit (kit #WODC.BLOW) is equipped with a three prong power cord and may be installed at any time. Follow installation instructions supplied with the kit. Route power supply cord away from heater.

Electrical rating: 115 volts A.C.-1.02 amps.
Fan output rating: 125 CFM

Blower Installation

1. Loosen the 2 screws at the center of the blower.
2. Install the temperature snap-switch assembly onto the blower by placing the bracket over the screws.
3. Tighten the screws.
4. Ensure that the two wires are connected to the temperature snap-switch.
5. Bend over the blower clearance tab and shown in the picture.
6. Feed the power cord into the pedestal base and out through the round hole near the bottom.
7. Slide the temperature snap-switch assembly up into the space between the rear shield and the firebox, ensuring that the temperature snap-switch contacts the firebox.
8. Install the two screws through the flange of the blower into the rear shield.
9. Plug the power supply cord in and check blower operation.

FIG. #5

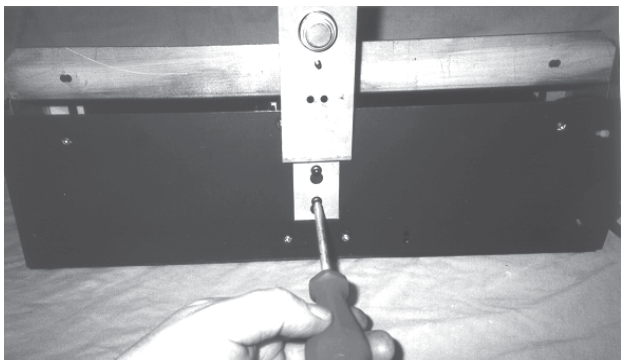
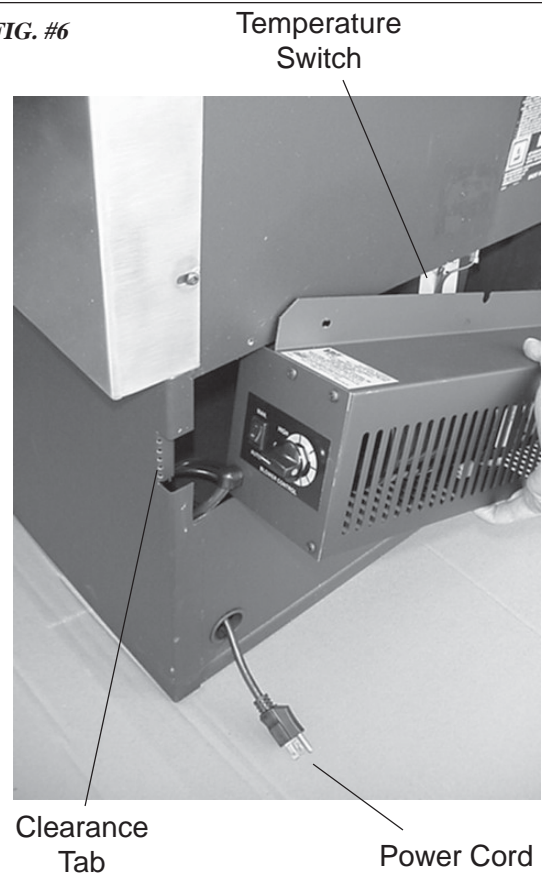

FIG. #6



Blower Operation

Proper blower speed matched with air control setting will ensure peak performance from your stove. Operate as follows:

- Air control set to low (right-most position), operate blower speed control on "Low".
- Air control set between low and high, operate blower speed control at desired setting.

Automatic: To operate the blower automatically, set the rocker switch on the side of the fan housing to "Auto" and set the speed control to desired setting. This will allow the fan to turn on as the stove heats up to operating temperature. It will also shut the blower off after the fire has gone out and the unit cooled to below a useful heat output range.

Manual: To manually operate the blower, set the rocker switch to "Man" and set the speed control to desired setting. This will bypass the sensing device and allow full control of the blower.

Switching from "Auto" to "Man" or selecting speed may be done anytime.

Appendix A

Troubleshooting

Problem	Cause	Cure
Glass is Dirty	1. Wood is wet	- Use dry wood
	2. Turning down air control or damper too soon	- Do not turn down until <ol style="list-style-type: none">there is a good bed of coalsthe wood is charred
	3. Draft too low	- Improper chimney height and / or diameter - Chimney plugged or restricted, check flue - Provide outside air for combustion
	4. Door gasket leakage	- Replace gasket - Check latch
Excessive Creosote Buildup - See 1,2,3, above.		
Low Heat Output	1. Wood is wet	- Use dry wood
	2. Fire too small	- Build a larger fire
	3. Draft too low	- Chimney plugged or restricted, inspect and clean
Won't Burn Overnight	1. Air control is set too high	- Set control lower
	2. Not enough wood	- Unsplit wood is preferred for overnight burns
	3. Draft too high	- Excessive chimney height and/or diameter, see page 11
Stove Won't Burn	1. Combustion air supply blocked	- Check outside air supply for obstruction - Check that room air cover is removed
	2. Draft too low	- Chimney plugged or restricted, inspect and clean - Chimney oversized or otherwise unsuitable, consult Dealer

Replacement Parts

(WHEN ORDERING, INCLUDE PART NUMBER WITH DESCRIPTION)

ITEM	DESCRIPTION	PART NO.	ITEM	DESCRIPTION	PART NO.
1a	Side Shield, Left, Mocha	FSND.46025MCA	12a	Firebrick - 1 1/2" x 4 1/2" x 1 1/4" (1 pc.)	248
	Side Shield, Left, Brushed Nickel	FSND.46025BNA	12b	Firebrick - 3" x 4 1/2" x 1 1/4" (1 pc.)	247
1b	Side Shield, Right, Mocha	FSND.4602MCA	12c	Firebrick - 4" x 4 1/2" x 1 1/4" (1 pc.)	246
	Side Shield, Right, Brushed Nickel	FSND.4602BNA	12d	Firebrick - 7 1/4" x 4 1/2" x 1 1/4" (1 pc.)	245
2	Top Air Deflector, Mocha	FSND.4603MCA	12e	Firebrick - 9" x 4 1/2" x 1 1/4" (17 pc.)	5096.99
	Top Air Deflector, Brushed Nickel	FSND.4603BNA		Firebrick Set	BRIC.SSERA
3	Door Catch	WODC.1461	13a	Brick Rail, Left (Latch Side)	SSER.4122001
4	Glass Clamps (4 pc.)	DRFS.4633	13b	Brick Rail, Right (Hinge Side)	SSER.4122101
5	Glass Bar Set (2 pc.)	WODC.41405		Replacement Baffle Kit	SSER.DBAKIT
6	Replacement Glass (c/w Tape)	DR31.WGLKIT	14a	Baffle (not sold separately)	SSER.DBAF
7	Door Gasket Kit	DR31.WDGKIT	14b	Side Insulation (not sold separately)	5068.732.B
8	Door Frame	DRFS.4610WLD	15	Baffle Pin	125
9	Door Frame Overlay, Mocha	DRFS.4611MCA	16	Baffle Gasket	139.5
	Door Frame Overlay, Brushed Nickel	DRFS.4611BNA	17	Flame Shield (c/w Bolt and Nut)	SSER.4115
10	Door Handle Assembly	DRFS.4635	18	Air Shutter Assembly	FSND.4631
11	Boost Manifold	4105	19	Baffle Air Control Assembly	SSER.214
			20	Ash Dump Assembly	WODC.2261
			21	Ash Box	FSND.4615

All parts may be ordered from your nearest Pacific Energy dealer. Contact Pacific Energy for the location of the dealer nearest you.

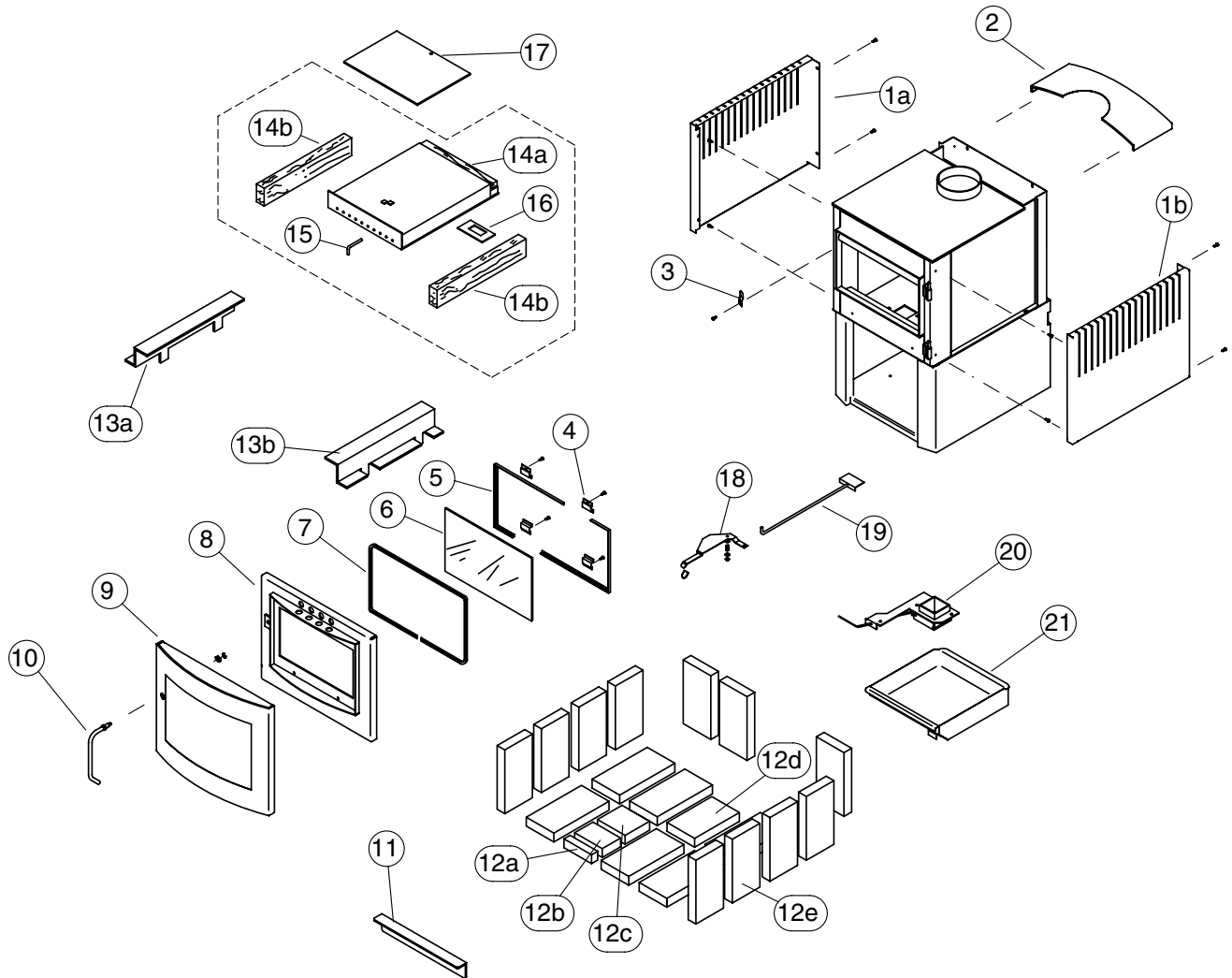

Label

WH-



CERTIFIED FOR CANADA AND U.S.A.
LISTED ROOM HEATER, SOLID FUEL TYPE.
ALSO FOR USE IN MOBILE HOMES
TESTED TO CAN/ULC S627-M93 AND UL 1482-98

DO NOT REMOVE THIS LABEL

WH-

MODEL SERIES D: FUSION

- INSTALL AND USE IN ACCORDANCE WITH THE MANUFACTURER'S INSTALLATION AND OPERATING INSTRUCTIONS.
- CONTACT LOCAL BUILDING OR FIRE OFFICIALS ABOUT RESTRICTIONS, INSTALLATION PERMIT AND INSPECTION IN YOUR AREA.
- DO NOT CONNECT THIS UNIT TO A CHIMNEY FLUE SERVING ANOTHER APPLIANCE (USA. ONLY).
- USE 6 INCH / 150MM DIAMETER MINIMUM 24 MSG BLACK OR LISTED CONNECTOR.
- CONNECT TO A LINED MASONRY CHIMNEY SUITABLE FOR USE WITH SOLID FUELS.
- DO NOT OBSTRUCT THE SPACE BENEATH THE HEATER.
- SEE LOCAL BUILDING CODE AND MANUFACTURER'S INSTRUCTIONS FOR PRECAUTIONS REQUIRED WHEN PASSING A CHIMNEY THROUGH A COMBUSTIBLE WALL OR CEILING.
- DO NOT PASS A CHIMNEY CONNECTOR THROUGH A COMBUSTIBLE WALL OR CEILING.
- MINIMUM CLEARANCE BETWEEN SINGLE WALL CHIMNEY CONNECTOR AND COMBUSTIBLE MATERIALS-18INCHES/ 455MM. CLEARANCE MAY BE REDUCED BY THE USE OF LISTED PIPE SHIELDS, WALL PROTECTORS OR OTHER MEANS APPROVED BY LOCAL BUILDING OR FIRE OFFICIALS.

MINIMUM CLEARANCES TO COMBUSTIBLE MATERIALS						
	RESIDENTIAL INSTALLATION USING SINGLE WALL CONNECTOR		RESIDENTIAL CLOSE CLEARANCE INSTALLATION USING DOUBLE WALL CONNECTOR		*ALCOVE INSTALLATION USING DOUBLE WALL CONNECTOR	MOBILE HOME INSTALLATION USING DOUBLE WALL CONNECTOR
	VERTICAL CONNECTOR	HORIZONTAL CONNECTOR	VERTICAL CONNECTOR	HORIZONTAL CONNECTOR		
A. SIDEWALL TO UNIT	19 in. / 483 mm	15 in. / 381 mm	15 in. / 381 mm	15 in. / 381 mm	17 in. / 432 mm	17 in. / 432 mm
B. BACKWALL TO UNIT	13.5 in. / 305 mm	9.5 in. / 241 mm	6.5 in. / 165 mm	6.5 in. / 165 mm	11.5 in. / 292 mm	9.5 in. / 241 mm
C. CORNER TO UNIT	11.25 in. / 286 mm	11.25 in. / 286 mm	4.25 in. / 108 mm	4.25 in. / 108 mm	N/A	8.25 in. / 210 mm
D. SIDEWALL TO CONNECTOR	27 in. / 685 mm	23 in. / 585 mm	22.5 in. / 570 mm	22.5 in. / 570 mm	24.5 in. / 620 mm	24.5 in. / 620 mm
E. BACKWALL TO CONNECTOR	19 in. / 485 mm	15 in. / 380 mm	11.5 in. / 292 mm	11.5 in. / 292 mm	16.5 in. / 420 mm	14.5 in. / 370 mm
F. CORNER TO CONNECTOR	22 in. / 560 mm	22 in. / 560 mm	14.5 in. / 370 mm	14.5 in. / 370 mm	N/A	18.5 in. / 470 mm

HORIZONTAL CONNECTOR NOT PERMITTED IN MOBILE HOMES
 † AS TESTED - PIPE SHIELD MAY BE REQUIRED BY LOCAL AUTHORITIES.
 * COMBUSTIBLE ALCOVE SIZE : DEPTH - 4 FT. / 1.22 M MAXIMUM, HEIGHT 7 1/2 FT. / 2.3 M MINIMUM
 COMBUSTIBLE FLOOR MUST BE PROTECTED BY A CONTINUOUS NON-COMBUSTIBLE MATERIAL EXTENDED TO THE FRONT, SIDES AND BACK AS INDICATED.

- IN CANADA**
- G. 18 INCHES / 455 MM
 - H. 8 INCHES / 200 MM
 - I. 8 INCHES / 200 MM
- IN U.S.A.**
- G. 16 INCHES / 405 MM
 - H. 5 INCHES / 127 MM
 - I. 0 INCHES / 0 MM

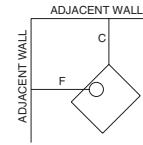
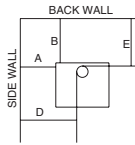
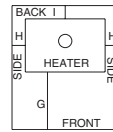

- COMPONENTS REQUIRED FOR MOBILE HOME AND ALCOVE INSTALLATION: OUTSIDE AIR KIT, AND ONE OF THE FOLLOWING LISTED CONNECTORS: SECURITY MODELS DP OR DC, OLIVER MACLEOD MODEL PV, ENERGY VENT E VENT, SELKIRK METALBESTOS MODEL DS, METAL FAB MODEL DW, AMERI-TEC MODEL DBSP, INDUSTRIAL CHIMNEY MODEL EXCEL ULTRA-BLACK, OR SIMPSON DURA-VENT MODEL DVL IN COMBINATION WITH ONE OF THE FOLLOWING COMPATIBLE CHIMNEY SYSTEMS: APPLIANCE MUST BE INSTALLED WITH PEDESTAL OR LEG KIT ATTACHED.
- IN CANADA - SECURITY MODEL S2100, OLIVER MACLEOD PROJET MODEL HT 3000, SELKIRK SENTINEL MODEL CF, INDUSTRIAL CHIMNEY MODEL EXCEL 2100.
- IN USA - SECURITY MODEL ASHT OR S2100, OLIVER MACLEOD MODEL 3103 OR HT 3000, SELKIRK METALBESTOS MODEL SS II, METAL FAB MODEL 2100, AMERI-TEC MODEL HS, INDUSTRIAL CHIMNEY MODEL EXCEL 103HT, SIMPSON DURA-VENT MODEL DURA/PLUS AND DURA TECH.
- USE COMPONENTS SPECIFIED IN PACIFIC ENERGY INSTALLATION INSTRUCTIONS.
- OPTIONAL COMPONENTS - WATER COIL (CANADA ONLY), FAN KIT #SSER.BLOW, FAN ELECTRICAL RATING: 115V, 60HZ, 80WATTS. DO NOT ROUTE POWER CORD BENEATH HEATER.
- CAUTION: RISK OF EXCESSIVE TEMPERATURES - KEEP ASH DUMP CLOSED DURING FIRING OF THE HEATER.
- OPERATE ONLY WITH FEED DOOR CLOSED. OPEN TO FEED FIRE ONLY.
- KEEP FURNISHINGS AND OTHER COMBUSTIBLE MATERIALS WELL AWAY FROM HEATER.
- REPLACE GLASS ONLY WITH CERAMIC GLASS.



CANADA'S FINEST STOVES

MANUFACTURED BY:
 PACIFIC ENERGY FIREPLACE PRODUCTS LTD.
 P.O. BOX 1060, DUNCAN, BC V9L 3Y2



CAUTION

HOT WHILE IN OPERATION. DO NOT TOUCH. KEEP CHILDREN, CLOTHING AND FURNITURE AWAY. CONTACT MAY CAUSE SKIN BURNS. SEE NAMEPLATE AND INSTRUCTIONS.

U.S. ENVIRONMENTAL PROTECTION AGENCY
 CERTIFIED TO COMPLY WITH
 JULY, 1990, PARTICULATE
 EMISSION STANDARDS

26504 5050.7623

DATE OF MANUFACTURE

J	F	M	A	M	J	J	A	S	O	N	D
2004	2005	2006	2007	2008	2009						

MADE IN CANADA

FSND-1



CANADA'S FINEST STOVES

PACIFIC ENERGY FIREPLACE PRODUCTS LTD.

2975 Allenby Rd., Duncan, BC V9L 4T8

Phone: 250-748-1184

Web site: <http://www.pacificenergy.net>