



**HOME OWNER / INSTALLER
FOR YOUR SAFETY
THIS MANUAL MUST BE READ IN ITS
ENTIRETY BEFORE OPERATING HEATER**

RHFE-431WTA

ENERGYSAVER FAN TYPE DIRECT VENT WALL FURNACE

Owner's Operation and Installation Manual



WARNING: IF THE INFORMATION IN THIS MANUAL IS NOT FOLLOWED EXACTLY, A FIRE OR EXPLOSION MAY RESULT CAUSING PROPERTY DAMAGE, PERSONAL INJURY OR LOSS OF LIFE.

DO NOT STORE OR USE GASOLINE OR OTHER FLAMMABLE VAPORS AND LIQUIDS IN THE VICINITY OF THIS OR ANY OTHER APPLIANCE.

WHAT TO DO IF YOU SMELL GAS

- DO NOT TRY TO LIGHT ANY APPLIANCE.
- DO NOT TOUCH ANY ELECTRICAL SWITCH; DO NOT USE ANY PHONE IN YOUR BUILDING.
- IMMEDIATELY CALL YOUR GAS SUPPLIER FROM A NEIGHBOR'S PHONE. FOLLOW THE GAS SUPPLIER'S INSTRUCTIONS.
- IF YOU CANNOT REACH YOUR GAS SUPPLIER, CALL THE FIRE DEPARTMENT.

INSTALLATION AND SERVICE MUST BE PERFORMED BY A QUALIFIED INSTALLER, SERVICE AGENCY OR THE GAS SUPPLIER.

This appliance may be installed in an aftermarket, permanently located, manufactured home (USA only) or mobile home, where not prohibited by local codes.

This appliance is only for use with the type of gas indicated on the Rating Plate. This appliance is not convertible for use with other gases, unless a certified kit is used.

Rinnai

**INSTALLER: MUST LEAVE MANUAL WITH UNIT AFTER INSTALLATION.
OWNER: RETAIN THIS MANUAL SAFELY, FOR FUTURE REFERENCE.**

WARNING

IMPROPER INSTALLATION, ADJUSTMENT, ALTERATION, SERVICE OR MAINTENANCE CAN CAUSE PROPERTY DAMAGE, PERSONAL INJURY OR LOSS OF LIFE. REFER TO THE OWNER'S INFORMATION MANUAL PROVIDED WITH THIS APPLIANCE. INSTALLATION AND SERVICE MUST BE PERFORMED BY A QUALIFIED INSTALLER, SERVICE AGENCY OR THE GAS SUPPLIER.

ENERGYSAVER RHFE-431WTA

Table of Contents

	Page
FEATURES OF THE RHFE-431WTA UNITS/SAFETY DEVICES	1
TECHNICAL DATA	2
IMPORTANT POINTS/USAGE AND INSTALLATION MUSTS	2
DIMENSIONS.....	4
SPECIFICATIONS	5
SAFETY POINTS	7
GETTING TO KNOW YOUR NEW RHFE-431	9
CONTROL PANEL/LED DISPLAY	10
CUT-AWAY DIAGRAM.....	11
NOTICE BEFORE INSTALLATION	12
INSTALLATION INSTRUCTIONS.....	13
GAS CONNECTION.....	14
VENT LOCATION	15
FITTING TOP SPACE+WALL CLIP.....	15
USA/CANADIAN VENT REGULATIONS	16
LOCATION/CLEARANCES.....	17
SLEEVE AND MANIFOLD INSTALLATION	19
OPERATING INSTRUCTION LABEL	23
SETTING THE CLOCK	24
OPERATING THE HEATER MANUALLY	25
PROGRAMABLE WEEKLY TIMER	26
OVERRIDE FUNCTION	33
FROST PROTECTION.....	34
ENERGY SAVING MODE	35
FUNCTION LOCK	36
TESTING/CHECK	37
PRE-SERVICE CHECK.....	38
TROUBLE SHOOTING	39
ERROR MESSAGES	40
MAINTENANCE/SERVICE.....	41
WIRING DIAGRAM	42
WARRANTY INFORMATION	43
SCHEMATIC DIAGRAM/PARTS LIST	45
RHFE-431WTA FLOW DIAGRAM.....	55
EXTENDED FLUE PIPE KIT	56

FEATURES OF THE RHFE-431WTA UNITS

- ◆ Clean Heating Forced Flue Type
- ◆ Easy Operation One-Touch Ignition
- ◆ Sensible Temperature Control Feature
- ◆ Comfortable Room Temperature Control and Display
- ◆ Warm Air Outlet at Floor Level (Keeps Your Feet Warm)
- ◆ Child Safety Function Lock
- ◆ Room Temperature Setting Memory
- ◆ Dirty Air Filter Indicator Lamp
- ◆ Energy-Saving Economy Setting
- ◆ Humidifier Tray
- ◆ Air Flow Directional Louvers
- ◆ Direct Vent Easily Installed
- ◆ Proportional Heating Variable Capacity
- ◆ Hush! Quiet Operation
- ◆ Modern Design Minimizes Floor Space Requirements
- ◆ Failure Message Display
- ◆ Timer Override Mode

SAFETY DEVICES

Spark Safety Device: Automatically shuts unit down when there is an abnormal spark at time of ignition.

Flame Failure Device: Activated when burner flame fails. This prevents raw gas from being released.

Overheat Switch: This device automatically cuts the gas off if the heater exceeds a predetermined temperature. This is normally caused by an obstruction in front of the louvers, or a blocked fan filter.

Fusible Links: Backs up the overheat switch. If the fusible link cuts the unit off, a service call by an authorized person is required to replace the link.

Overcurrent Prevention Device: This is a 3 amp. glass fuse found on P.C. board. Design to shut unit down in case of overcurrent. If fuse blows all indicator lamps will be "OFF".

Power Outage Safety Device: This safety device cuts off gas passage and stops operation.

TECHNICAL DATA





WEIGHT	DIMENSIONS	GAS RATE (BTU/h)					
		INPUT			OUTPUT		
51 Lbs.	Width: 29 1/2" Height: 21 13/16" Depth: 9 13/16"		NG	LP		NG	LP
		LOW	8,200	8,200	LOW	6,640	6,640
		HIGH	16,700	16,700	HIGH	13,400	13,400

Burner Orifices:

RHFE-431WTA-P use: Orifice part #AU129-210×02-0.85(0.033")

RHFE-431WTA-N use: Orifice part #AU129-210×02-1.13(0.044")

GAS CONVERSION SPECIFICATIONS

MODEL	GAS TYPE	DIAMETER OF ORIFICE(mm)	PRIMARY DAMPER	SECONDARY DAMPER	MANIFOLD DIFFERENTIAL PRESSURE (W.C.)		DIP SWITCH POSITION
					HI	LO	
RHFE-431WTA	NG	φ 1.13	556F-209-7	556F-208-7 (33×47hole)	2.4"W.C.	0.7"W.C.	ON  OFF 
RHFE-431WTA	LPG	φ 0.85	556F-209-15	556F-208-5 (φ 2.5×15)	2.8"W.C.	0.8"W.C.	ON  OFF 

GAS SUPPLY PRESSURE

	NATURAL	PROPANE
MINIMUM	3.5"W.C.	8"W.C.
MAXIMUM	10.5"W.C.	13"W.C.

- The minimum inlet gas supply pressures is for the purpose of input adjustment.
- Heaters may be converted from one gas to another using Rinnai conversion kits.

IMPORTANT POINTS / USAGE AND INSTALLATION MUSTS

Unpack heater and check for damage. (DO NOT INSTALL DAMAGED HEATER.) If heater is damaged, contact your supplier for advice. Before installing a heater, check the label for the correct gas type (see label on side of heater). Refer to local gas authority for confirmation of gas type if you are in doubt.

Included in Carton:

- Customers Operating Information
- Conversion kits

IMPORTANT

Before using this product, please read this manual carefully to insure proper use of product.

1. The installation must conform with local codes or, in absence of local codes, the National Fuel Gas Code, ANSI Z223.1 or the Canadian Installation Code, CAN/CGA-B149.
2. For information on gas type, see data plate on the appliance.
3. This heater must not be installed where curtains or other combustible materials could come into contact with it. In some cases curtains may need restraining.

4. This appliance is not designed to be built in.
5. If you move, check the gas type in the area where you are moving to. The local gas authority will be able to advise on local regulations.
6. This heater discharges a large volume of warm air at low level to provide even heat distribution. If the air in the room contains cooking vapor or cigarette smoke, and the heater is used on a carpet, the surface of the carpet may become discolored. In addition, some nylon carpets contain dyes which may be affected by the warm air flow. Some soft vinyl surfaces are also subject to distortion, or discoloration by warm air. To prevent discoloration of carpets, etc., a mat should be placed under the appliance, extending about 30" (750mm) in front of it.

Diagram shows minimum clearances from combustible materials.

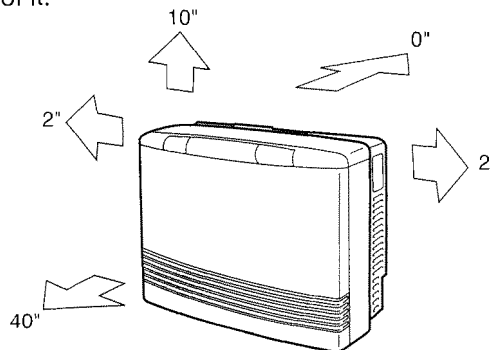

7. Read these rules and the instructions carefully. Check all local codes. Failure to follow these could cause a malfunction of the heater resulting in death, serious bodily injury and/or property damage.
8. This appliance is only for use with the type of gas indicated on the rating plate. This appliance is not convertible for use with other gases, unless a certified kit is used.
If a conversion of the unit is needed, conversions must be performed at Rinnai America or authorized agent at owner's expense.
9. **WARNING:** Any change to this heater or its controls can be dangerous.
10. If a gas leak is suspected, turn heater off, turn gas supply valve off at appliance connector valve. Open windows to ventilate area immediately and contact your dealer or gas company.
11. **DO NOT PLACE CLOTHING OR FLAMMABLE MATERIALS, GASOLINE AND OTHER FLAMMABLE VAPORS AND LIQUIDS, ON OR NEAR THE HEATER.**
12. **YOUNG CHILDREN SHOULD BE CAREFULLY SUPERVISED WHEN THEY ARE IN THE SAME ROOM WITH THE HEATER.**
13. LPG containers must not be installed indoors.
14. Do not use this room heater if any part has been under water. Immediately call a qualified service technician to inspect the room heater and to replace any part of the control system and any gas control which has been under water.
15. Adequate clearances for accessibility for purposes of servicing and proper operation should be provided.
16. Adequate clearances around air openings should be provided.
17. Do not install in areas where curtains, drapes, clothing, or other moving flammables are within 12 inches of this unit.
18. Periodic examination of the venting system is required.
19. The flow of combustion and ventilation air should not be obstructed.
20. A A manufactured home (USA only) or mobile home OEM installation must conform with the Manufactured Home Construction and Safety Standard, Title 24CFR, Part 3280, or, when such a standard is not applicable, the Standard for Manufactured Home Installations, ANSI Z225.1 or Standard for Gas Equipped Recreational Vehicles and Mobile Housing, CSA Z240.4.
21. "This appliance must be installed in accordance with the current standard CSA Z240.4 GAS EQUIPPED RECREATIONAL VEHICLES AND MOBILE HOUSING. Cet appareil doit être installé conformément aux exigences de la norme Z240.4 en vigueur de l'ACNOR, Installations de gaz dans les constructions mobiles et véhicules récréatifs."

22. If a blockage occurs at vent terminal due to snow, leaves or other type of obstruction the unit will stop working. The unit will not function until blockage has been removed, then if unit fails to operate, contact a qualified service agency.
23. For a manufactured home (USA only) or mobile home OEM or residential installation, this unit has been designed and certified to be converted from natural gas to propane or vice-versa. When provisions are being made to convert this unit, a certified conversion kit must be used. You must also readjust manifold gas pressure to specifications indicated in the conversion manual. If in doubt, contact Rinnai America for assistance.



GENERAL INFORMATION

THIS SERIES HEATER IS DESIGN CERTIFIED BY CSA INTERNATIONAL AS A DIRECT VENT WALL FURNACE AND MUST BE INSTALLED ACCORDING TO THESE INSTRUCTIONS. ALTERATION OF THE ORIGINAL DESIGN INSTALLED OTHER THAN AS SHOWN IN THESE INSTRUCTIONS OR USED WITH A TYPE OF GAS NOT SHOWN ON THE RATING PLATE, IS THE RESPONSIBILITY OF THE PERSON AND COMPANY MAKING THE CHANGE.

- Rinnai is continually updating and improving products. Therefore, specifications are subject to change without notice.
- Thank you for purchasing Rinnai forced flue gas heater.
- Please read the warranty thoroughly and keep it in a safe place.

DIMENSIONS

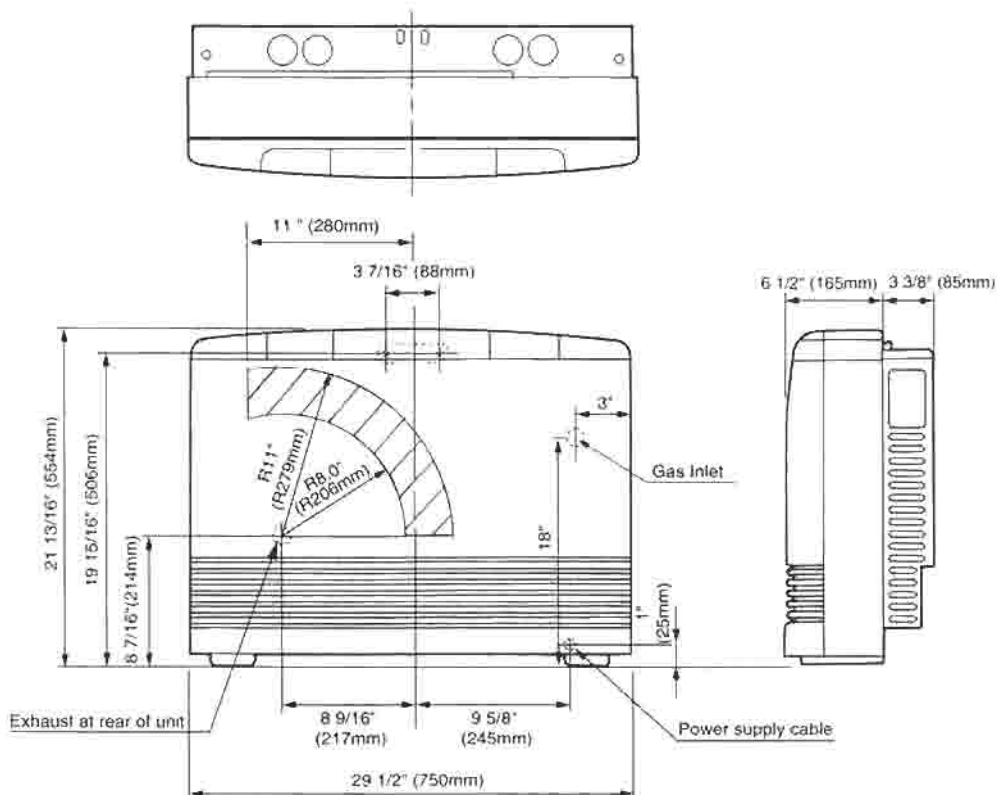

SPECIFICATIONS

MODEL #	BTU/h		MIN. CLEARANCES			FAN CFM OUTPUT
	INPUT	OUTPUT	SIDE	TOP	FRONT	
RHFE-431WTA	Low 8,200	Low 6,640	2" (50mm)	10" (250mm)	40" (1m)	LO:110.5
NATURAL	High 16,700	High 13,400				HI:141.3
RHFE-431WTA	Low 8,200	Low 6,640	2" (50mm)	10" (250mm)	40" (1m)	LO:110.5
PROPANE	High 16,700	High 13,400				HI:141.3

SPECIFICATIONS

Type of Appliance	Fan Type Direct Vent Wall Furnace	
Model	RHFE-431WTA ENERGY SAVER	
Dimensions	Width— 29 1/2" (750mm) Depth— 9 13/16" with back spacer (250mm with back spacer) Height— 21 13/16" (554mm)	
Weight	Approx. 51 lbs.	
Connections	Electrical—AC 120V 60Hz 43 watts Gas—1/2" female NPT	
Combustion System	Stainless steel bunsen burner	
Ignition System	Continuous spark	
Operation	Finger touch control buttons	
Temperature Control	Electronic thermostat HI-LOW/OFF Up/down switch	
Temperature Range	Normal Operation	Frost Function
	LOW=50°F 60°F~80°F HI=High Combustion	38°F~60°F
Warm Air Outlet	Bottom front louver	
Operating Buttons	On/off, Auto, Override, Economy, Frost, Timers, Select, Clock, Up/down	
Economy Mode	Energy saving feature	
Humidifier Tray	Capacity—3 pints (1300cc)	

Safety Devices	Flame failure – Flame rod Over heat – Bi-metal switch, thermal fuse, thermistor Power failure – PCB Power surge – 3 Amp. fuse Fan delay – Micro computer timer Pre-purge – Combustion fan, pre-purge timer, spark sensor Room over heat – Automatic cut off at 104°F after 10 minutes	
Noise Level Range	HI~LOW=38~32dB(A)	
TYPE	Combustion Method	Forced combustion
	Air Supply Exhaust	Closed Type
	Radiation Method	Forced convection
AIR SUPPLY/ EXHAUST PIPE	Wall Penetration Hole	3 1/8" (80mm)
	Max. Extended Length	(4m, 2 bends)=13ft., 2 bends

SPECIFICATIONS FOR VENT SIZES		
S	3"—4 1/2" (75—115mm)	Thin Walls Mobile Home
A	4 1/2"—9 1/2" (115—240mm)	Wood Walls
B	9 1/2"—15 3/4" (240—400mm)	Wood/Brick
C	15 3/4"—23 5/8" (400—600mm)	Brick/Block
D	23 5/8"—31 1/2" (600—800mm)	Special

** BTU - Efficiency increases with vent Extension. Clearances from combustibles see pages 3 and 18.

** Thermal efficiency rating determined under continuous operating conditions, and was determined independently of any installed system.

SAFETY POINTS

Do not restrict the warm air discharge by placing articles in front of the heater.

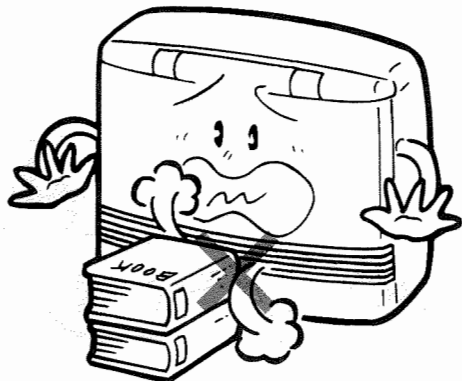

This appliance must not be used for any purpose other than heating.



Do not spray aerosols while the heater is operating. Most aerosols contain butane gas, and can be a fire hazard if used near this heater when it is in use.



Do not install the heater in an unusually dusty area.

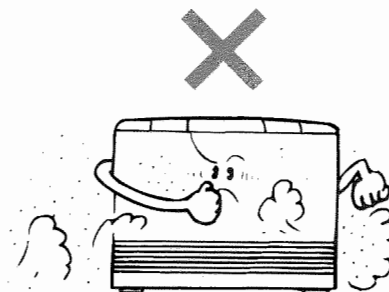

Do not allow curtains or other flammable or combustible materials to come into contact with the heater.

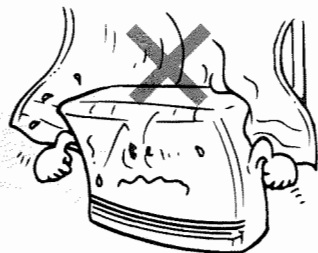

Combustible materials must not be placed where the heater could ignite them.

Do not allow anyone to sit on or lean against the appliance.



SAFETY POINTS

Keep flammable materials, trees, shrubs, etc., away from the flue terminal.

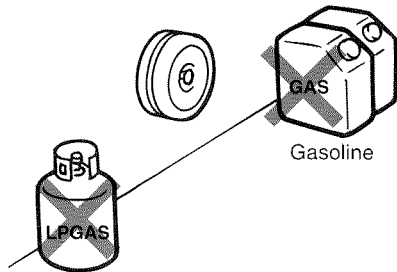

Do not allow anyone to poke articles through the louvers.

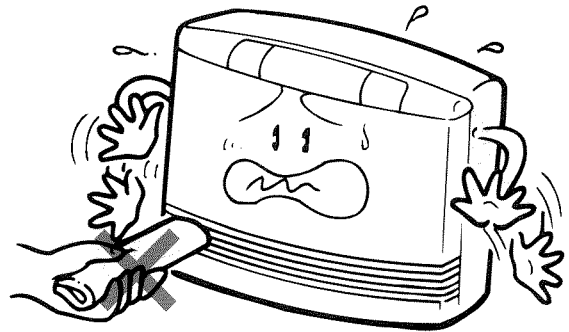

Filter should be cleaned at regular intervals. See page 31.

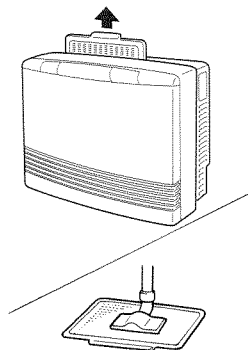

Clean as needed.

Young children should be supervised at all times. Hand or body contact with the louvers should be avoided.

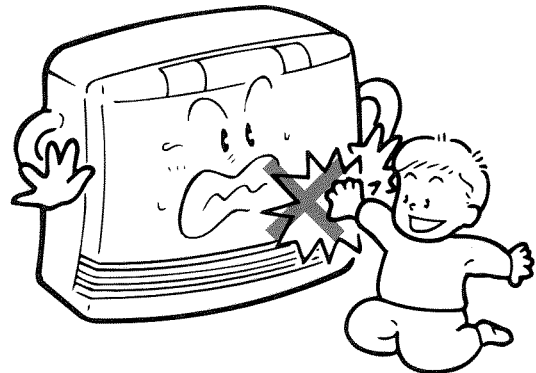

Do not place articles containing liquids on top of the heater. Liquids spilled on the controls may cause extensive damage.

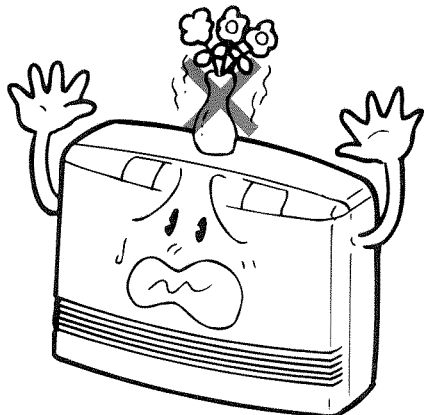

Do not allow young children or an infant to sleep directly in front of the heater.

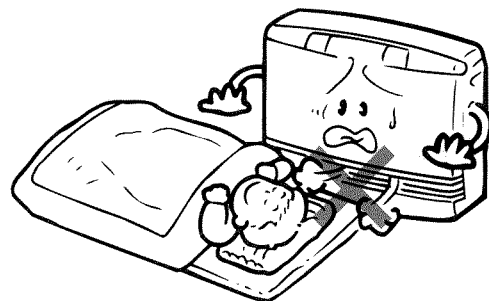

GETTING TO KNOW YOUR NEW RHFE-431

WARM AIR OUTLET

HUMIDIFIER
REMOVE BOTTOM
COVER AND PULL
OUT TO REFILL

BOTTOM COVER
HOLD BOTH SIDES
AND PULL TOWARD
YOU

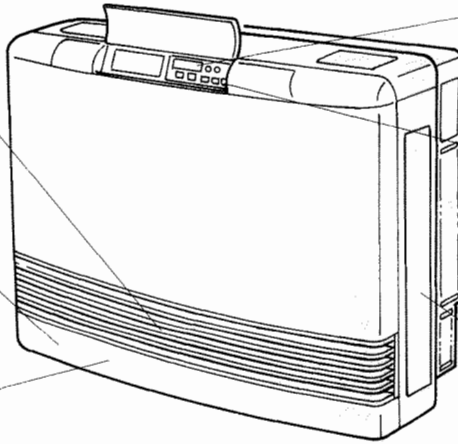

DISPLAY
TEMPERATURE/
TIMERS
SETTING CONTROLS

ON/OFF SWITCH
TURNS MAIN POWER
ON/OFF

RATING PLATE
MODEL NUMBER,
SERIAL NUMBER,
GAS TYPE, ETC.

TERMINAL BLOCK
FOR COMBUSTION FAN

THERMISTOR

GAS CONNECTIONS
1/2" NPT

POWER CORD

PLUG 120V AC

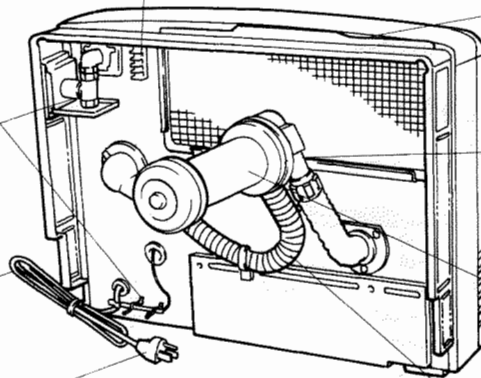

AIR FILTER

EXHAUST PIPE

VENT TERMINAL
COMBUSTION/
EXHAUST

COMBUSTION AIR
INTAKE HOSE

CONTROL PANEL

Clock: used to set the current time and day. (refer to page 24).

Select: When programming the timers, this button is used to select and confirm day, time and temperature settings.

Timers: used to carry out timer programming and confirm all settings.

Up/Down: function of these buttons varies depending on the operating mode. (refer to the table below for details).

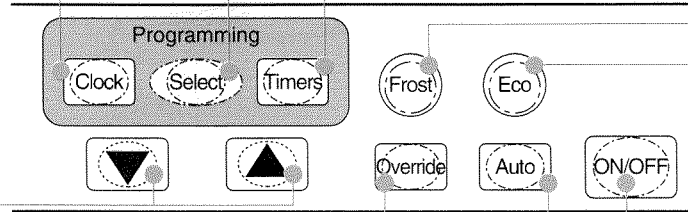

Frost: used to initiate the Frost mode and allows for a minimum frost temperature to be set (refer to page 34).

Eco: used to select the Economy mode (refer to page 35).

ON/OFF: this is the main on/off switch for the heater.

Override: overrides the current timer setting by reversing the current operation (see page 33).

Auto: toggles the heater between AUTO (for timer operation) and MANUAL operation modes.

MODE OPERATION

MODE	OPERATION
Clock Set	To set current time and day
Timer Program	Select days of week, time and temperature
Frost Protection	Set Frost Protection temperature

LED DISPLAY

Days: shows current day of week or day(s) being programmed.

Temperatures: shows pre-set and room temperatures.

Frost: indicates that the anti-frost mode is on and that a minimum anti-frost temperature can be entered.

Clock: shows current time or pre-set program time for timer.

Auto/Man: indicates Manual or Timer operation mode.

Override On/Off: indicates whether the Override function is on and whether it has turned the heater on or off (reverse function).

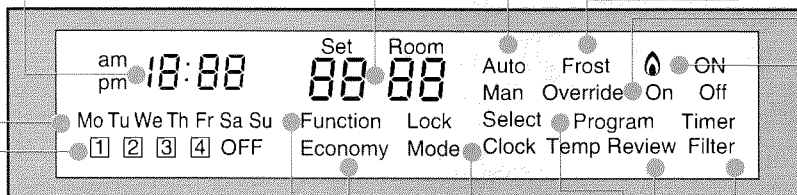

ON/ : indicates when the heater is operating and whether the burner is alight ().

Periods: shows current operating period or period being programmed.

Clock: shows when the clock is being set.

Review: indicates that the review mode is on.

Filter: shows when the filter needs to be cleaned.

Function Lock: indicates that the function lock is on.

Economy Mode: indicates that the Economy Mode is on.

Select Program Timer/Temp: indicates when the timers are being programmed - Start time "Select Program Timer" or Temperature "Select Program Temp".

CUT-AWAY DIAGRAM

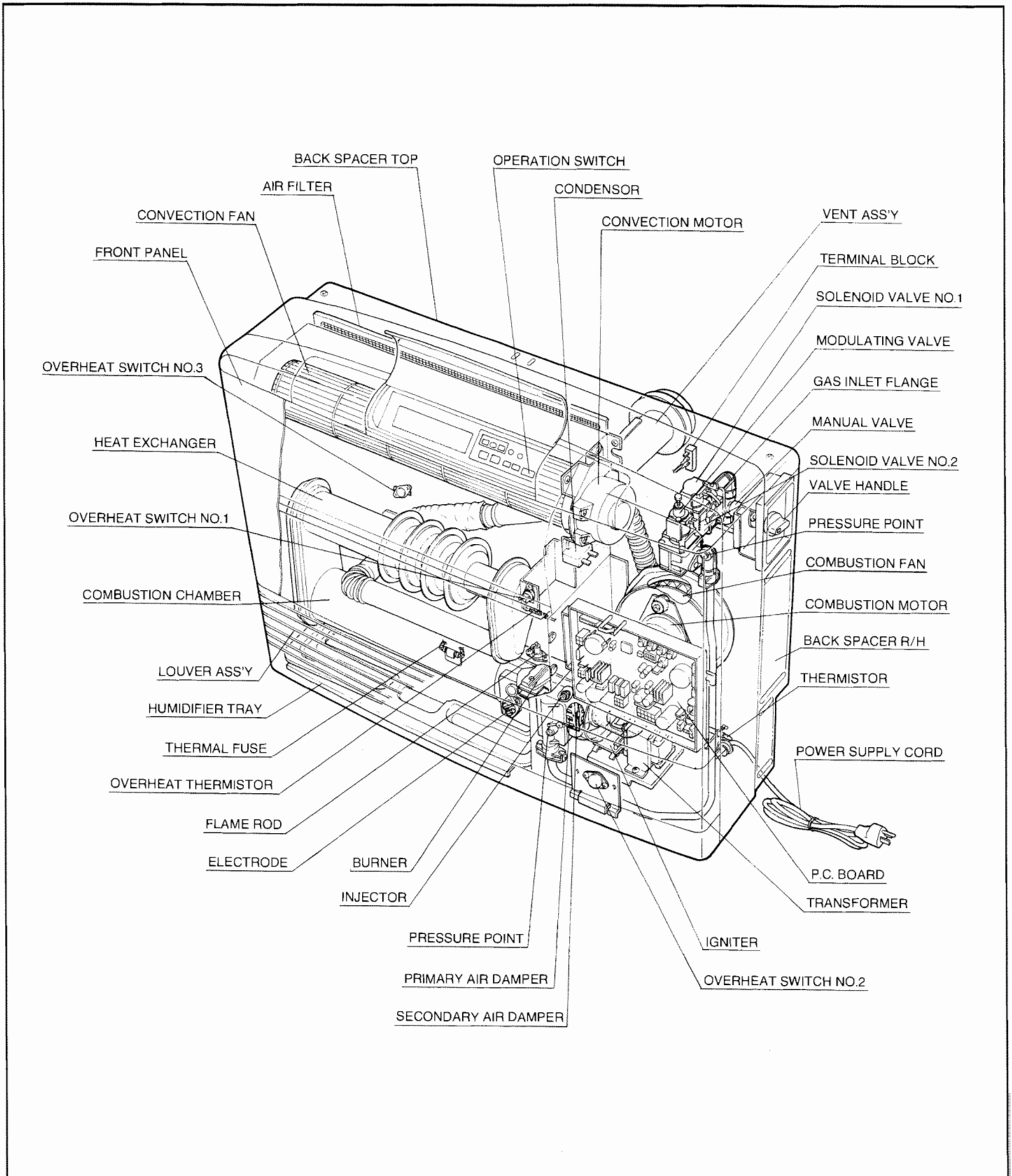

NOTICE BEFORE INSTALLATION

The heater must be installed by a qualified service person according to this installation instruction.

Check your local building codes for the proper method of installation. In the case of absence of local codes, this heater should be installed in accordance with the National Fuel Gas Code ANSI Z223—1.

Check local codes or, in the absence of local codes, the current CAN/CGA—B149 INSTALLATION CODE.

DUE TO HIGH TEMPERATURES, THE APPLIANCE SHOULD BE LOCATED OUT OF TRAFFIC AND AWAY FROM FURNITURE AND DRAPERIES. CHILDREN AND ADULTS SHOULD BE ALERTED TO THE HAZARDS OF HIGH SURFACE TEMPERATURES AND SHOULD STAY AWAY TO AVOID BURNS OR CLOTHING IGNITION.

“WARNING” Do not operate appliance with the panel(s) removed, cracked or broken. Replacement of the panel(s) should be done by a licensed or qualified service person.

INSTALLATION AND REPAIR SHOULD BE DONE BY A QUALIFIED SERVICE PERSON. THE APPLIANCE SHOULD BE INSPECTED BEFORE USE AND AT LEAST ANNUALLY BY A QUALIFIED SERVICE PERSON. MORE FREQUENT CLEANING MAY BE REQUIRED DUE TO EXCESSIVE LINT FROM CARPETING, BEDDING MATERIAL, ETC. IT IS IMPERATIVE THAT CONTROL COMPARTMENTS, BURNERS AND CIRCULATING AIR PASSAGEWAYS OF THE UNIT BE KEPT CLEAN.

The appliance, when installed, must be electrically grounded in accordance with local codes or, in the absence of local codes, with the National Electrical Code, ANSI/NFPA 70 or Canadian Electrical Code, CSA C22.1, if an external electrical source is utilized.











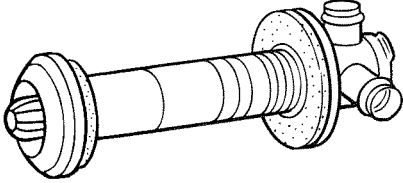

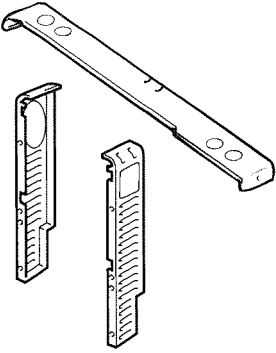

WARNING: THIS APPLIANCE IS EQUIPPED WITH A THREE-PRONG (GROUNDING) PLUG FOR YOUR PROTECTION AGAINST SHOCK HAZARD AND SHOULD BE PLUGGED DIRECTLY INTO A PROPERLY GROUNDED THREE-PRONG RECEPTACLE. Do not cut or remove the grounding prong from the plug.

This gas appliance must not be connected to a chimney flue serving a separate solid-fuel burning appliance. When the appliance is installed directly on carpeting, tile or other combustible material other than wood flooring, the appliance shall be installed on a metal or wood panel extending the full width and depth of the appliance.

Rinnai recommends a dedicated electrical circuit.

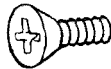
Appliance input ratings are based on sea level operation and need not be changed for operation up to 2,000 feet elevation. For operation at elevations above 2,000 feet, manufactured to specified deration conditions for Canada and the United States.

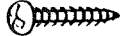
INSTALLATION INSTRUCTIONS

Flue Manifold1		Spare rubber seal1 (‘A’ Flue units only)			
					
(For weatherboard installations)					
Back Spacer Set		1	Flue Locking Clamp		1
			Flue Lock Stopper		1
			Insulation Clip		1
			Hose Clip		2
Customers operating information and Installation Instructions		1	Plastic tie for air inlet		1
Air Filter		1	(M4×20)		1
(M4)	 For Back Spacer Set	6	(M4)		3
(M4)	 For Air Intake Clip	2	(M4.8×32) Wood Screws		5
Wall Bracket		1	Spacer Bracket		1

Check to ensure gas supply matches that of the appliance.
 Refer to local gas authority for confirmation of gas type if in doubt.
 Refer to data plate located inside of the front panel.
 Check for damage, if the unit is damaged contact your supplier or Rinnai.
 Do not install a damaged unit before checking with your supplier.
 Refer to an approved pipe sizing chart if in doubt about size of gas line.

GAS CONNECTION

1. The gas supply line shall be gas-tight, sized and so installed as to provide a supply of gas sufficient to meet the maximum demand of the heater without loss of pressure.
2. A shut off valve (and appliance connector valve) should be installed in the upstream of the gas line to permit servicing.
3. Flexible pipe and any appliance connector valve used for gas piping shall be types approved by nationally recognized agencies.
4. Any compound used on the threaded joint of the gas piping shall be a type which resists the action of liquefied petroleum gas.
5. Supplied gas pressure must be within the limits shown in the specifications.
6. After completion of gas pipe connections, all joints including the heater must be checked for gas tightness by means of leak detector solution, soap and water, or an equivalent nonflammable solution, as applicable.

CAUTION: Since some leak test solutions, including soap and water, may cause corrosion or stress cracking, the piping shall be rinsed with water after testing, unless it has been determined that the leak test solution is noncorrosive.

7. The appliance and its appliance main gas valve must be disconnected from the gas supply piping system during any pressure testing of that system at test pressures in excess of 1/2 P.S.I (3.5kPa).

The appliance must be isolated from the gas supply piping system by closing its individual manual shut off valve during any pressure testing of the gas supply system at test pressures equal to or less than 1/2 psig.

8. Two 1/8" test plugs are provided for testing of manifold differential pressure see schematic for location.

At time of installation installer must supply a 1/8" N.P.T. plugged tapping, accessible for test manometer connection, immediately up stream of the gas supply connection to the appliance.

VENT LOCATION

FLUE MANIFOLD POSITION

Center of hole for flue manifold can be drilled anywhere within the shaded area. (To avoid studs, etc.)

FOR WEATHERBOARD WALLS DRILL THROUGH CENTER OF WEATHER BOARD FROM OUTSIDE, THEN DRILL FROM INSIDE THROUGH PLASTERBOARD.

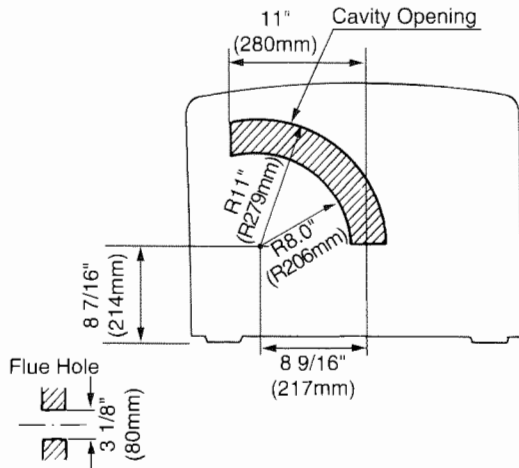

Before drilling the flue hole, check for water and gas pipes as well as electric cables. Use a 3 1/8" (80mm) drill for hole through wall.

WALL MOUNTING BRACKETS

Place top back spacer in position. Mark the position of the top edge of the top spacer on the wall. Move the heater away from the wall. Mark center lines 1 1/8" (30mm) down from the top edge mark, and 1 9/16" (40mm) from the left and right hand sides of the top spacer. Attach wall brackets at the marked position.

FITTING TOP SPACER + WALL CLIP

Tighten all screws.

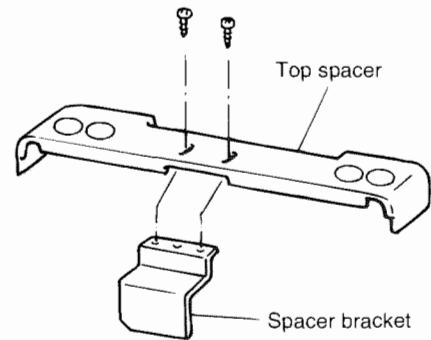

SECURE HEATER TO WALL

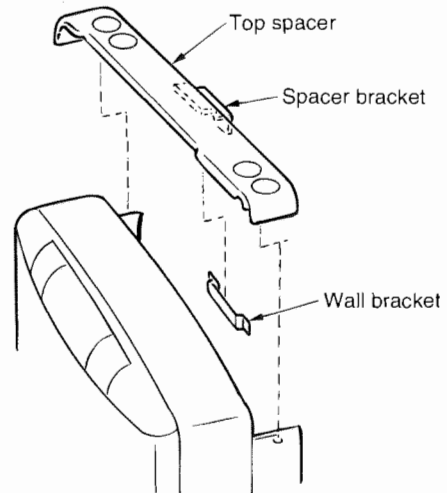

Replace top spacer, clipping the spacer into the wall brackets at the same time as attaching it to the heater. Secure top spacer with the screws provided. THE HEATER IS NOW SECURED TO THE WALL.

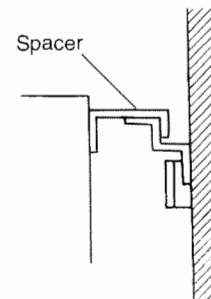

Replace fan filter.

CANADIAN VENT REGULATIONS

CAN/CGA-B149.1-M91

A vent shall not terminate:

- (a) Directly above a paved sidewalk or paved driveway which is located between two singlefamily dwellings and serves both dwellings;
- (b) less than 7 ft. (2.13m) above a paved sidewalk or a paved driveway located on public property;
- (c) within 6 ft. (1.8m) of a mechanical air supply inlet to any building;
- (d) above a meter/regulator assembly within 3 ft. (900mm) horizontally of the vertical centerline of the regulator;
- (e) within 6 ft. (1.8m) of any gas service regulator vent outlet;
- (f) less than 1 ft. (300mm) above grade level;
- (g) within the following distances of a window or door which can be opened in any building, any non-mechanical air supply inlet to any building or the combustion air inlet of any other appliance;
 - (i) 1 ft (300mm) for inputs up to and including 100,000 Btu/h (30kW),
 - (ii) 3 ft (900mm) for inputs exceeding 100,000 Btu/h (30kW); and
- (h) underneath a veranda, porch or deck, unless
 - (i) the veranda, porch or deck is fully open on a minimum of two sides beneath the floor, and
 - (ii) the distance between the top of the vent termination and the underside of the veranda, porch or deck is greater than 1 ft. (300mm).

FOR COMPLIANCE TO NFPA 54 OR Z223-1-1992 U.S.A.

Vent terminal must be located at least 3 feet above any forced air inlet location within 10 feet away.

Vent terminal must not be located over public walk ways or be detrimental to regulators and equipment where condensate could be a problem.

Vent terminal must be kept clear of snow at all times.

The bottom of the vent terminal and the air intake must be located at least 12 inches above grade.

The vent terminal of a direct vent appliance with an input of 50,000 Btu per hour or less shall be located at least 9 inches from any opening through which flue gases could enter a building, and such an appliance with an input over 50,000 Btu per hour shall require a 12 inches vent termination clearance. The bottom of the vent terminal and the air intake shall be located at least 12 inches above grade.

LOCATION / CLEARANCES

When positioning the heater the main points governing the location are:

1. Flueing
2. Warm air distribution

This heater is not designed to be build in.

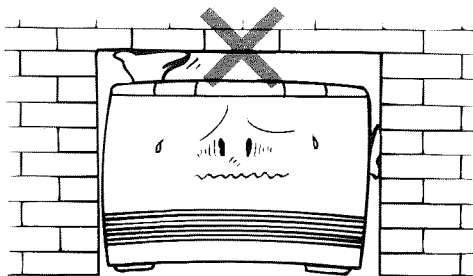

The flue is not designed to be positioned under floors, or below the level of the heater.

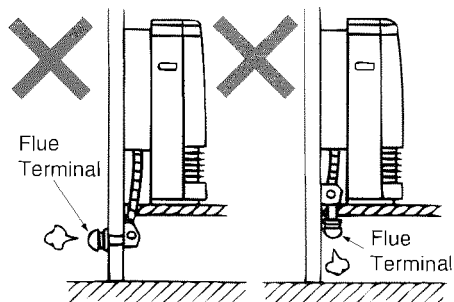

The flue terminal should be positioned away from flammable materials.

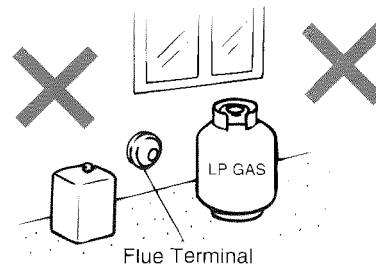

Do not flue into natural draught flues or fireplaces, this unit can only be used with one of the five types of Rinnai flue kits. Do not flue unit into other rooms. Flue terminal must be outside.

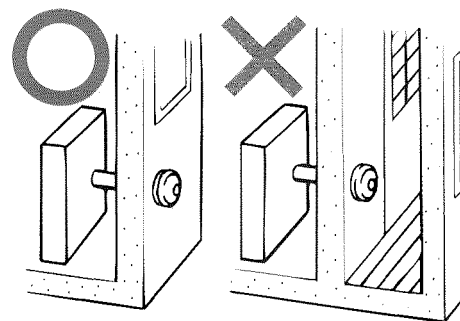

Flue may be positioned directly under opening windows, with a minimum clearance of 9" (230mm).

FLUE SIZES:

5 Flue lengths are available.

S flue walls 3"~4 1/2" (75~115mm)

A flue walls 4 1/2"~9 1/2" (115~240mm)

B flue walls 9 1/2"~15 3/4" (240~400mm)

C flue walls 15 3/4"~23 5/8" (400~600mm)

D flue walls 23 5/8"~31 1/2" (600~800mm)

SNOW AREAS

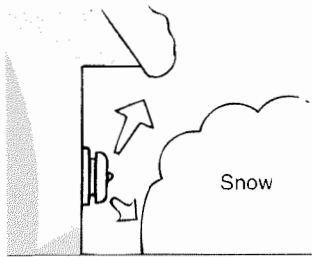

In areas subject to heavy snowfall, keep snow clear of flue terminal at all times.

STANDARD INSTALLATION OF FLUE MANIFOLD.

Diagram below shows minimum clearances and distances from obstructions. Also check local regulations.

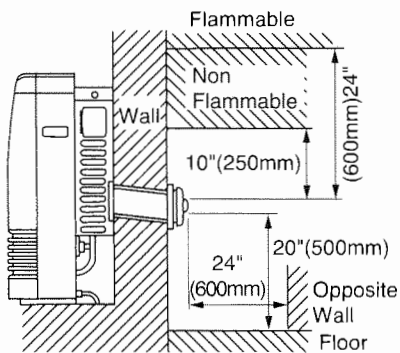

Side Clearances

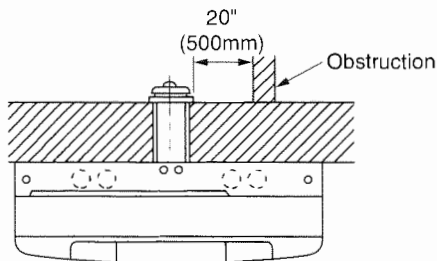

FIT BACK COVERS (SIDES ONLY)

Fit back covers (sides only) as shown below.

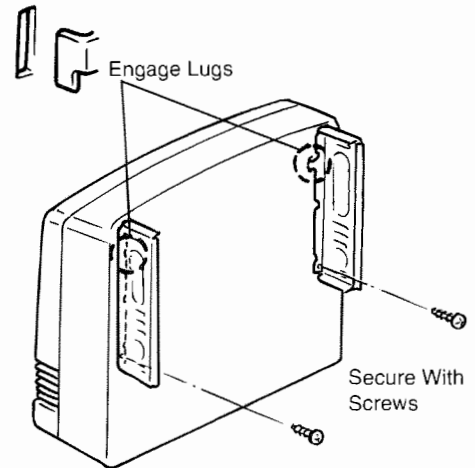

SLEEVE AND MANIFOLD INSTALLATION

METHOD FOR STANDARD WALLS

1. Disassemble Manifold from Sleeve.

The flue consists of 3 parts, sleeve, inside connectors and tube, outside terminal; (dis-assembly by pulling hard on outside terminal and inner connections, then pull sleeve off outer terminal.)

Note: Clearance to combustibles for terminal assembly sleeve and flanges is 0".

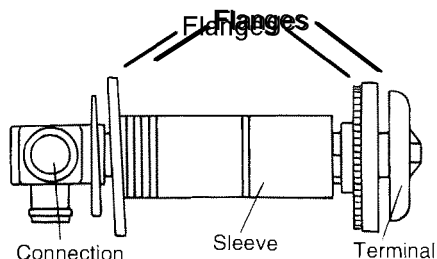

2. Adjustment of Sleeve Length.

Measure wall thickness through previously drilled 3 1/8" (80mm) hole.
End of sleeve should protrude 3/16"~3/8" (5~10mm) from outside wall. Adjust sleeve length to wall thickness plus 3/16"~3/8" (5~10mm). (Sleeve is threaded for adjustment.) Do not extend beyond red line.

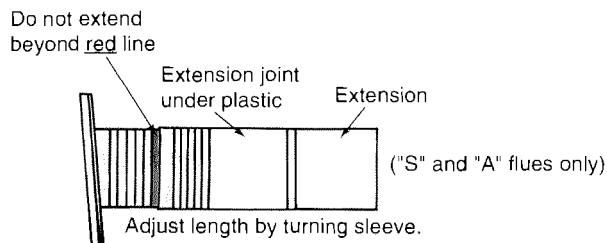

3. For S and A flue only.

Depending on flue set and wall thickness extension piece "C" may need to be removed.
Cut plastic, remove extension, then follow instruction 2.
This applies to "S" and "A" flues only.
There is no extension on other flues, they can be fully adjusted by turning the threaded section.

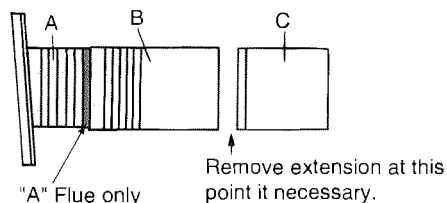

4. Fixing Sleeve.

Fix to the wall, using the 3 screws provided.

NOTE: The flange is marked "TOP", sleeve must be fitted with this mark **Up**. Check sleeve protrudes 3/16"~3/8" (5~10mm) on the outside.

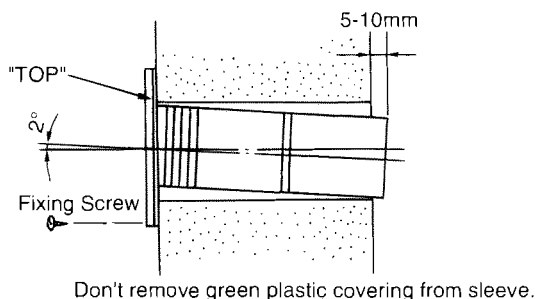

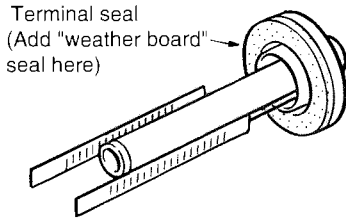
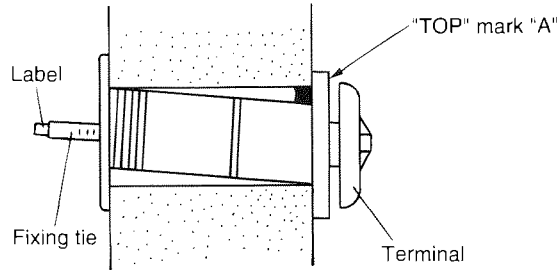
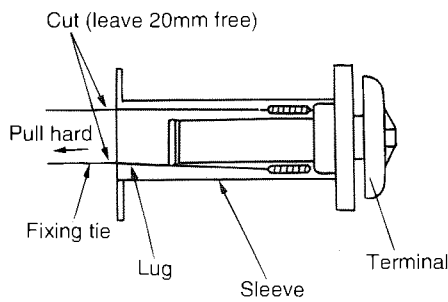
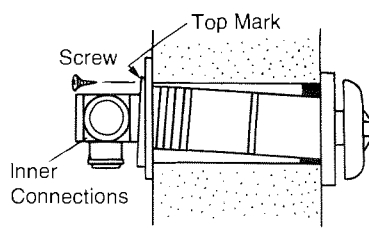
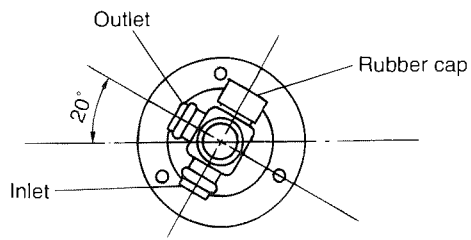
<p>5. Check rubber seal is in place on terminal.</p> <p>*For weather board walls, add spare rubber seal provided to compensate for weather board angle.</p>	
<p>6. Installation of Terminal</p> <p>From outside, insert terminal into sleeve with the "A" mark at the top. Left hand side fixing tie is marked "LEFT" (from inside).</p>	
<p>7. Attached Ties</p> <p>Pull hard on left and right hand side ties, clip ties over lugs inside sleeve. You should be able to pull ties 2 or 3 slots past the starting point. Cut the ties, leaving about 3/4" (20mm) past the lugs. Bend ties so they are parallel with the wall.</p>	
<p>8. Insert Inner Connection Assembly.</p> <p>Push assembly into the terminal tube, make sure "TOP" mark is uppermost. Fix with 3 screws provided.</p>	
<p>9. Manifold can still be turned after attaching.</p>	

FITTING UNIT

AIR INLET HOSE

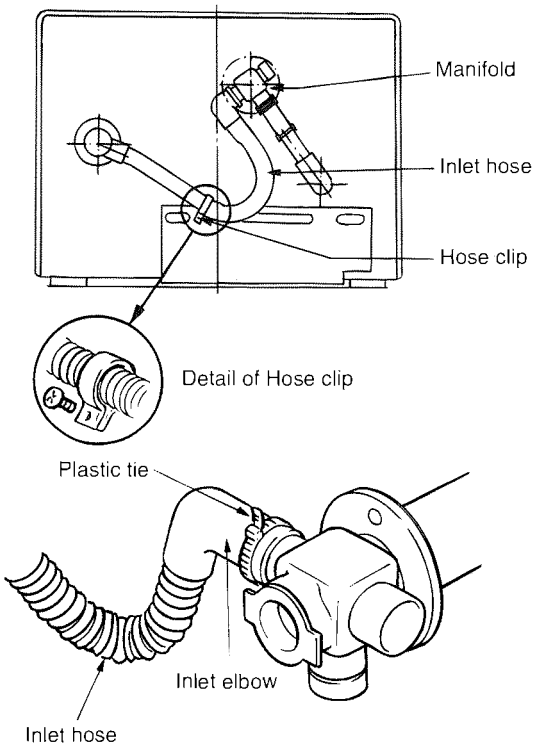

When servicing unit replace plastic tie with new one. (Available at local hardware store or contact local distributor.)

LOCKING CLAMP SCREW CLAMP AND INSULATION.

The following components can be fitted by reaching down the rear of the appliance as it is positioned against the wall.

1. Connect the flue outlet to the manifold by extending the stainless steel sliding tube until it is fully inserted into the manifold.

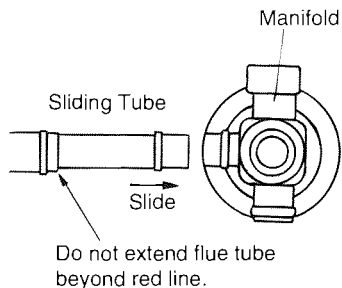

2. Fit the locking clamp over connection between sliding tube and manifold. Engage the hook and rotate it until it snaps against the body of the clamp.

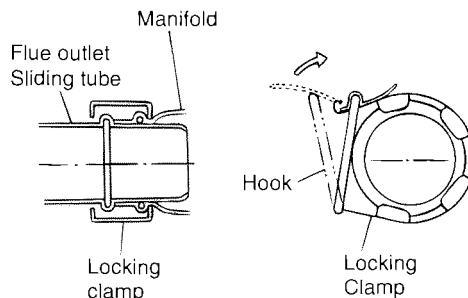

3. Fit the screw clamp between the sliding tube and the flue elbow. Secure with the 4mm screws supplied. The flue outlet is now locked into position.

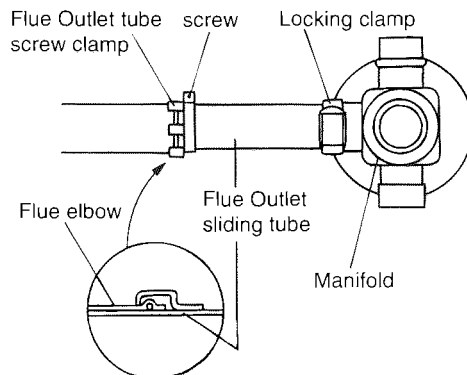

4. Slide the insulation sleeve up to the flue manifold, slip the securing clip over the sleeve as shown.

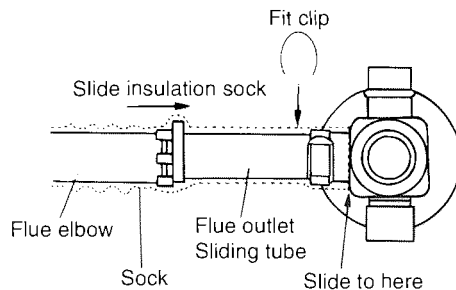

Levelling screws(Adjustable legs)

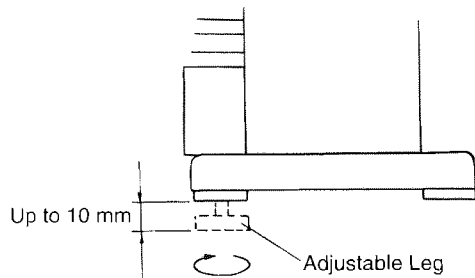

If necessary, the unit can be leveled using the adjustable legs under the front right and left hand side legs.

■ INSTRUCT CUSTOMER ON USE OF HEATER

When you are satisfied that the appliance is operating correctly, explain operation of heater to the customer.

Fault-Failure Procedure

If unable to get the heater to operating correctly, contact Rinnai directly or your Agent or Gas Utility.

Do not use electrical extension cords to connect unit to power supply. Keep the power cord away from the flue.

Some items are not covered under the unit's warranty. Example: annual maintenance, carbon on flame rods/ignitor, dust, spider webs, etc.

OPERATING INSTRUCTION LABEL ENERGYSAVER RHFE-431WTA

FOR YOUR SAFETY READ BEFORE OPERATING

WARNING: If you do not follow these instructions exactly, a fire or explosion may result causing property damage, personal injury or loss of life.

- A. This appliance does not have a pilot. It is equipped with an ignition device which automatically lights the burner. Do not try to light the burner by hand.
- B. BEFORE OPERATING smell all around the appliance area for gas. Be sure to smell next to the floor because some gas is heavier than air and will settle on the floor.
- WHAT TO DO IF YOU SMELL GAS
- Do not try to light any appliance.
 - Do not touch any electric switch; do not use any phone in your building.
 - Immediately call your gas supplier from a neighbor's phone. Follow the gas supplier's instructions.
- If you cannot reach your gas supplier, call the fire department.
- C. Use only your hand to push in or turn the gas control knob. Never use tools. If the knob will not push in or turn by hand, don't try to repair it, call a qualified service technician. Force or attempted repair may result in a fire or explosion.
- D. Do not use this appliance if any part has been under water. Immediately call a qualified service technician to inspect the appliance and to replace any part of the control system and any gas control which has been under water.

OPERATING INSTRUCTIONS

- STOP! Read the safety information above on this label.
1. Set the thermostat to lowest setting.
 2. Turn off all electric power to the appliance via the ON/OFF button on the control panel. Locate manual gas valve to be found on back side of heater.
 3. Turn Manual valve clockwise  to the full OFF position.
 4. Wait five (5) minutes to clear out any gas. Then smell for gas, including near the floor. If you then smell gas, STOP! Follow "B" in the safety information above on this label. If you don't smell gas go to next step.
 5. Turn Manual gas valve to the full on position.
 6. Turn on all electric power to the appliance via ON/OFF button.
 7. Set the thermostat to desired setting.
 8. Burner is lit when indicator lamp "ON" turns red.
 9. "ON" indicator flashes when burner fails to ignite.
 10. If the appliance will not operate, follow the instruction "TO TURN OFF GAS TO APPLIANCE" and call your service technician or gas supplier. See manual for additional information.

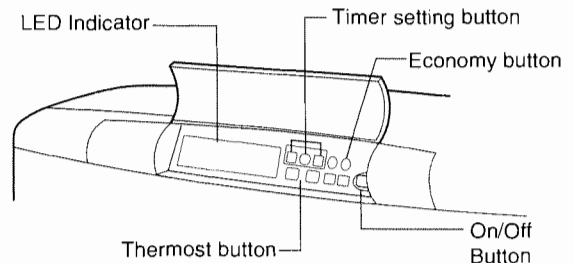
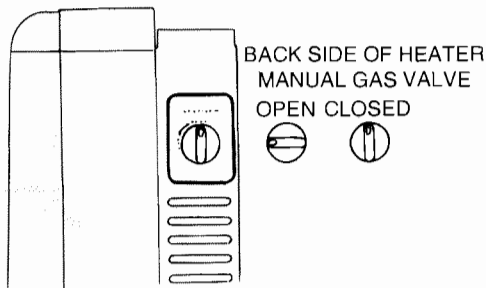

TO TURN OFF GAS TO APPLIANCE

1. Turn off electric power to the appliance using the ON/OFF button located on the control panel.
2. Locate manual valve on back side of unit.
3. Turn manual valve clockwise to the full OFF position.

NOTE: The fan will continue to operate until the appliance is cool, do not turn the appliance off by unplugging it from the wall. Keep burner and control compartment clean. See installation and operating instructions accompanying heater.

SETTING THE CLOCK

■ TO OPEN THE CONTROL PANEL

Lift lightly in the center of the lid. The control panel lid will then drop backward to an angle.

Note: When the appliance is first plugged in or after a power failure longer than 24 hours the display will show "PF".

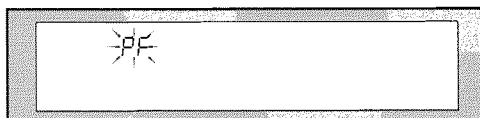

■ SETTING THE CURRENT TIME & DAY

(This example shows setting the clock to 8:20am on Saturday).

DAY OF THE WEEK

1 Press the "Clock" button once. The day of the week and Select Clock is displayed.

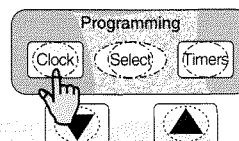
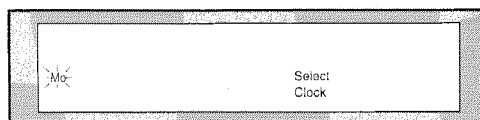

2 Press either of the "▲" or "▼" buttons until the correct day of the week is displayed.

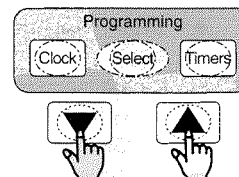
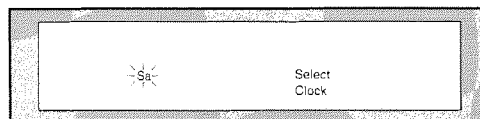

3 Press the "Select" button once to lock in and complete day of the week selection. The time of day will then flash.

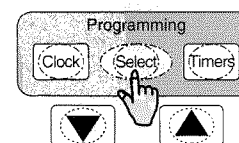
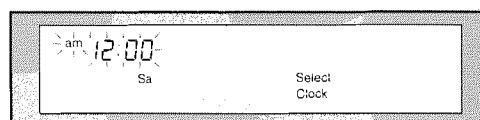

TIME OF DAY

4 To set the time press the "▲" or "▼" buttons until the correct time of day is displayed.

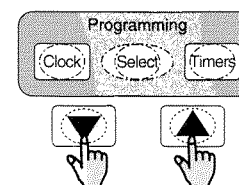
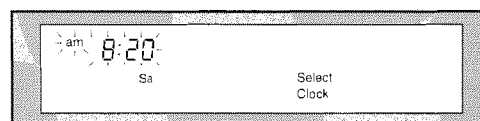

- Pressing either button once will change the time in single minutes.
- Holding either button down will change the time rapidly, first in minutes, then in hours.

CONFIRM SETTINGS

5 Press the "Select" or "Clock" button once to lock in and complete setting the time. The Select Clock indicators will go out.

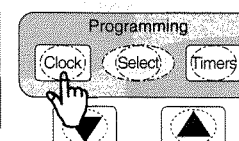
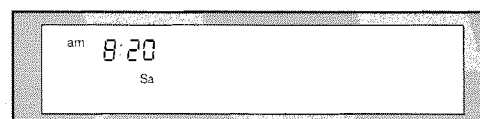

OPERATING THE HEATER MANUALLY

■ To turn the heater ON:

1 Press the "ON/OFF" button.



2 Check to see if the "Man" or "Auto" indicator is displayed:

If the "Auto" indicator is displayed then press the "Auto" button. The indicator will change to "Man". Go to Step 3.

If the "Man" indicator is displayed go to Step 3.

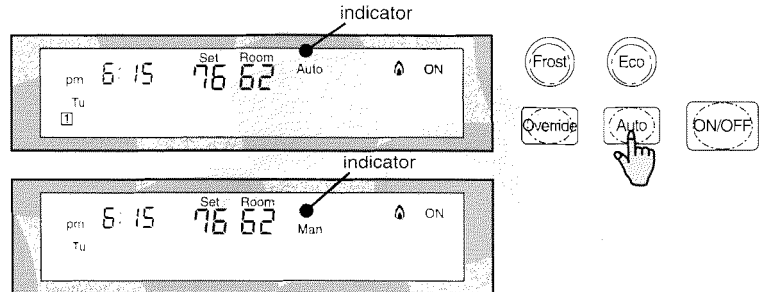

3 Select the desired room temperature by pressing the "▲" or "▼" buttons.

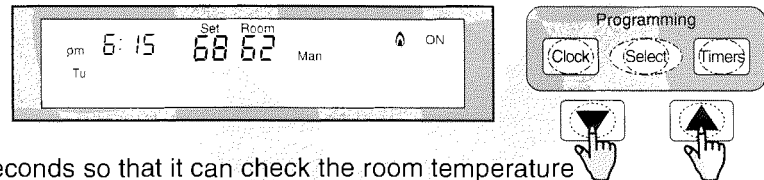

- The heater will start and run for 90 seconds so that it can check the room temperature (the  indicator will show).
- If the room temperature is lower than the pre-set or desired temperature the heater will continue to run.
- If the room temperature is higher than the pre-set or desired temperature, the heater will go into "stand-by" mode, and will start when the room temperature falls below the pre-set temperature.

If the heater does not ignite on initial use, this may be due to air remaining in the gas supply line. The spark generator will only continue for 15 seconds. After this it will be necessary to press the ON/OFF button OFF, then ON again.

■ To turn the heater OFF:

1 Press the "ON/OFF" button.

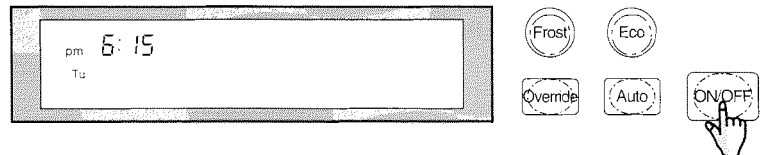

DO NOT turn heater off by unplugging the power cord. The convection fan will continue to run until the appliance cools.

PROGRAMMABLE WEEKLY TIMER

- The Rinnai 431WTA features a weekly timer which allows four separate time periods, each with its own temperature, to be set.
- These periods can be programmed differently for each day of the week, or for a group of days: weekdays, weekends or all days of the week together.
- The four timer periods create up to four separate operating intervals, each with its own temperature setting.
- The programming covers a 24 hour time span(one day).

The two diagrams below graphically represent an example weekday and weekend program.

WEEKDAY PROGRAM

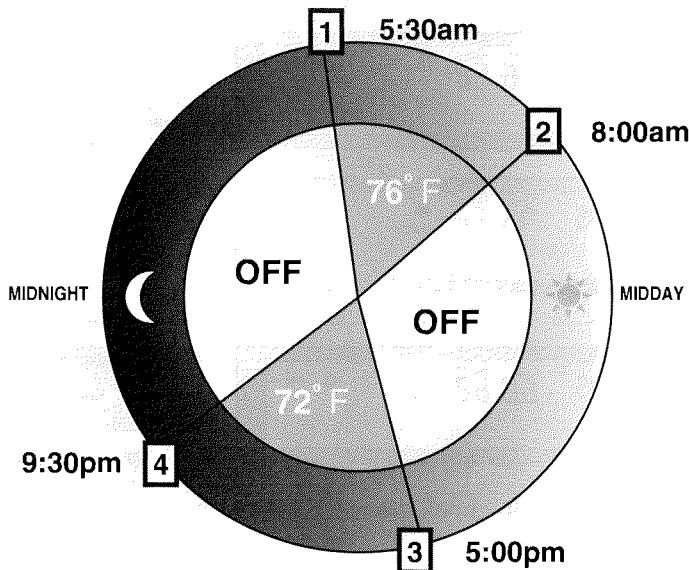

- The example weekday program period 1 has been programmed to start at 5:30 am with a temperature setting of 76°F.
- The heater will heat the room to 76°F from 5:30 am until 8:00 am, when period 2 starts.
- Period 2 has a temperature setting of "nothing" or OFF, and so the heater will not operate again until the start of period 3 at 5:00 pm, when it will heat the room to 72°F.
- Period 4 turns the heater OFF again until period 1 starts the timer cycle on the next day.

WEEKEND PROGRAM

- For example if you get up later on the weekends period 1 begins heating the home to 76°F at 9:00am.
- The heater has also been programmed to start heating the home earlier in the afternoon, and so period 3 starts at 4:00pm with a temperature setting of 72°F.
- Period 4 now has a temperature of LOW [50°F], and runs the heater on this setting all night.

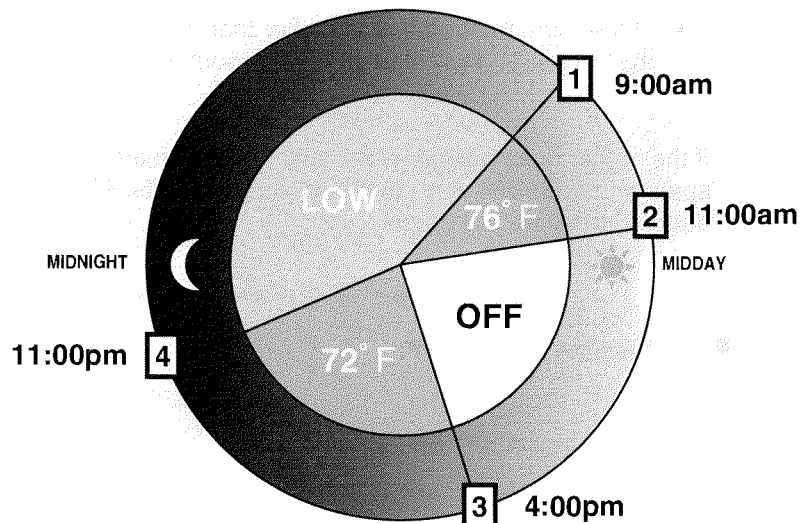

- A detailed step-by-step guide of setting the times and temperatures shown in the two examples above are given on pages 28-29.
- Before setting the heater we encourage you to think about and write down your own program. A blank table is provided on page 31 for you to do just this.

PROGRAMMING THE WEEKLY TIMERS

- The following is a general outline of the setting options and procedures available when programming the weekly timers. A detailed step-by-step example is given on pages 28 to 29.

Note: Before programming the current time and day must be set. See page 24 for instructions.

- The weekly timers can be easily programmed by following the steps illustrated below:

1 Press the "Timers" button once to activate the timer programming mode.



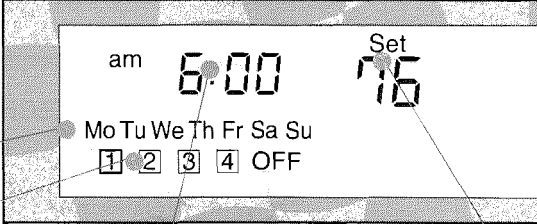

2 Select the day or group of days you wish to program by pressing the "up" and "down" buttons:



Choose from the following options:

Mo Tu We Th Fr Sa Su

Mo Tu We Th Fr

Sa Su

or each day of the week in turn.

If a group of days is chosen, the times and temperatures selected in steps 3 → 5 will automatically apply for those days.

Press the "Select" button to confirm your choice.



3 Select the period you wish to program by pressing the "up" and "down" buttons:



Periods 1 → 4 will automatically appear in order as you follow this programming sequence, so you may not need to manually select a timer period.

Press the "Select" button to confirm your choice.



4 Set the start time for this period by pressing the "up" and "down" buttons:



The time will move up or down in 10 minute increments.

Each period must be set to a later time than the period before it.

No period can be set past 11:50pm, as this is the end of the 24hour program.

Press the "Select" button to confirm the time.



5 Set the temperature you want for this period by pressing the "up" and "down" buttons:



Choose from the following temperature settings:

H(high) 80 → 60 L(low)
and
-- (OFF)

If you want heat during this period, choose a temperature.

If you do not want heat, choose the OFF setting.

Press the "Select" button to confirm the temperature setting.



6 Repeat steps **3** → **5** for periods 1 through to 4 until you are happy with all the settings.

7 Press the "Timers" button again to confirm your program and lock in all settings.

- For a description of how to operate the heater with these programmed settings, turn to page 26.

PROGRAMING THE TIMERS : EXAMPLE

Note: Before programing the timers, the clock must be set to the correct time(see page 24).

- The following is a step by step guide to programing the timers by an example schedule.
- A general outline for programing the timers is provided on page 26.
- If programing is paused for longer than 2 minutes the display will return to the current time, and all programing up to that stage will be lost.
- The times and temperatures in the EXAMPLE box below can be used for learning how to set the program able thermostat.

■ **EXAMPLE** Let's use the following schedule to program the weekdays...

EXAMPLE SCHEDULE

	Time Setting	Temperature
1	5:30 am	76°F
2	8:00 am	OFF
3	5:00 pm	72°F
4	9:30 pm	OFF

- This example schedule is the same as the **WEEKDAY PROGRAM** on page 26.

<p>1 Press the "Timers" button once. The display will show "Select Program Timer" and the "Mo Tu We Th Fr Sa Su" indicators will flash.</p>		
<p>2 Press the "▲" button once, the "Mo Tu We Th Fr" indicators will flash.</p>		
<p>3 Press the "Select" button once, the period 1 indicator will flash and the time and temperature display will be shown.</p>		
<p>4 Press the "Select" button again. The period 1 indicator will become stable, the temperature display will go out and the clock will flash.</p>		
<p>5 Press the "▼" button until the display shows "am 5:30" (as shown in the example schedule for period 1).</p>		
<p>6 Press the "Select" button again. The clock indicator will become stable, the pre-set temperature will flash and "Select Program Temp" will be shown.</p>		

PROGRAMING THE TIMERS : EXAMPLE cont...

- 7 Press the “▲” button to set the pre-set temperature to 76°F(remember, we are using the example schedule on page 28).

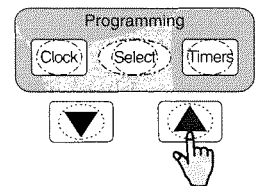
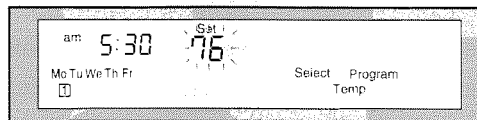

- 8 Press the “Select” button again. Now the period 2 indicator will flash and the time and temperature display will be shown.

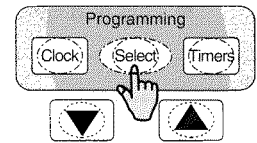
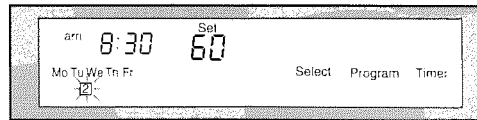

- 9 Press the “Select” button again. The period 2 indicator will become stable, the temperature display will go out and the clock indicator will flash.

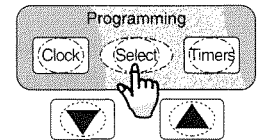
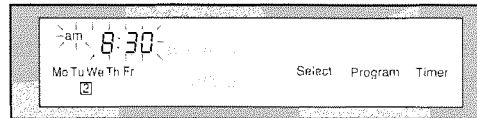

- 10 Press the “▼” button until the display shows “am8:00”(as in the example on page 28 for period 2).

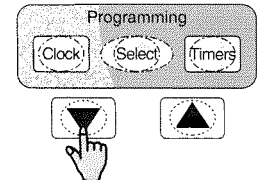
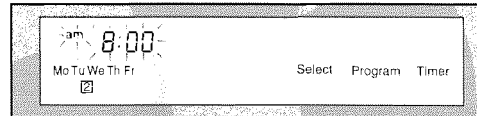

- 11 Press the “Select” button again. The clock indicator will become stable, the pre-set temperature will flash and “Select Program Temp” will be shown.

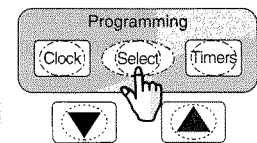
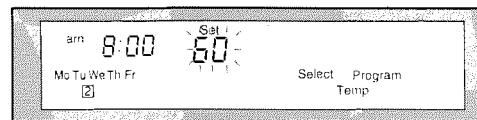

- 12 Press the “▼” button until the temperature shows “-” and the “OFF” indicator is displayed.

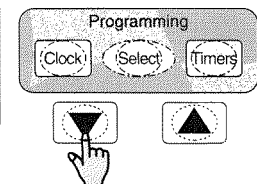
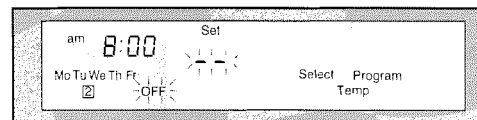

Set periods 3 and 4 following/repeating steps 3 to 7, and then go to step 13.

- 13 Press the “Select” button again. The period 1 indicator will flash and “Sa Su” will be displayed.

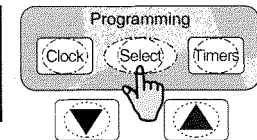
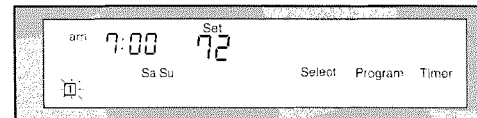

You can now program a Weekend schedule by repeating steps 3 to 7, and then go to step 14.

- 14 Once all timers are programed, Press the “Timers” button once to save all timer settings. The display will return to the current time and the “Set Program Timer” indicator will go out.

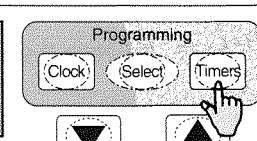
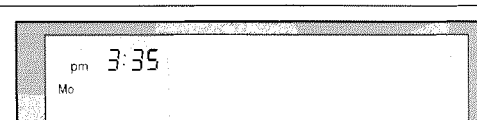

- To review all of the programed settings turn to page 30- “WEEKLY TIMER REVIEW FUNCTION”.
- For a description of how to operate the heater with these programed settings, turn to page 32- “OPERATING THE TIMERS”.

WEEKLY TIMER REVIEW FUNCTION

- This function lets you review all of the programmed Weekly Timer settings (times and temperatures) without the option of adjusting these settings, removing the danger of accidentally changing the program.
- This is a quick way to review the Weekly Timer program before operating the timers.

■ To enter the Weekly Timer Review mode:

NOTE: If the heater is left in "Timer Review Mode" for longer than 10 seconds without the "▲" or "▼" buttons being pressed, it will exit this mode and return the previous operation.

1

- Press and hold the "Timers" button for approximately 3 seconds (an audible "beep" will be heard).

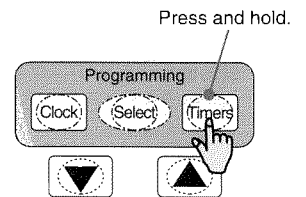
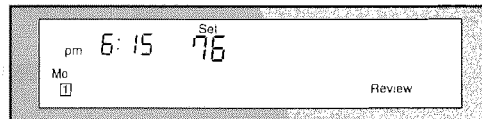

NOTE:

- The Period [1], "Mo", time, temperature, and "Review" indicators will show.

2

- Press the "▲" button repeatedly to review the Weekly Timer program.
- The four timer periods for each day of the week will show in turn, starting with "Mo" (Monday) then "Tu" etc.
- Press the "▼" button to go backwards through the program.

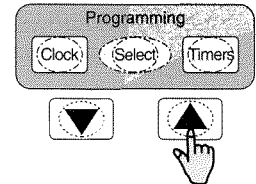
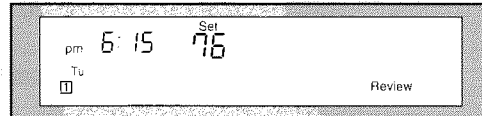

■ To exit the Weekly Timer Review mode:

1

- Press the "Timers" button.

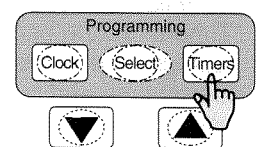
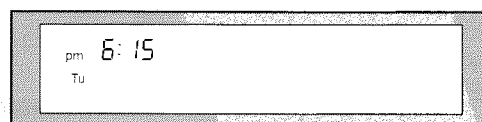

YOUR WEEKLY TIMER PROGRAM

Points to consider before writing your program:

- When do I want the heater to operate, and what temperature do I want?
- When do I not want the heater to operate?
- Will I use the same settings for everyday day of the week, or do I need a separate program for the weekdays, and the weekend? Do I need a separate setting for each day of the week?

Points to remember when writing your program:

- The four periods are set within a 24 hour time span.
- The start of a new period marks the end of the previous one, so each period only requires a START time.
- Period 4 ends with the start of period 1 on the next day(see page 26 for a reminder).
- Each period must be set to a later time than the one before it.
- If you want to heat during the period, select a temperature: H(high), 80 → 60, L(low).
- If you do not want to heat during this period, select the OFF setting.

Write your own program:

- Use the tables below to write your own weekly timer program, then turn to page 28 to program the timers.

	Start Time	Temperature or OFF
1		
2		
3		
4		

	Start Time	Temperature or OFF
1		
2		
3		
4		

FACTORY PRE-SET PROGRAM

- The heater comes shipped with a factory set program(opposite).
- If the heater is not set with a new program it will run according to this program when you operate the timers("Auto" mode-see page 32).
- If the Weekly Timer program settings are erased (see page 24), the heater will revert to this program.

WEEK DAY

	Start Time	Temp or OFF
1	6:00 am	72° F
2	8:30 am	60° F
3	5:00 pm	74° F
4	11:30 pm	60° F

WEEK END

	Start Time	Temp or OFF
1	7:00 am	72° F
2	12:00 pm	70° F
3	5:00 pm	74° F
4	11:30 pm	60° F

OPERATING THE TIMERS

■ Before operating the timers, please check the following points:

- The clock must be set to the current time and day - refer to page 24 for clock setting procedure.
- You may want to enter your own timer program. See page 26 for an overview of how the timers work, and page 27 for an explanation of how to set the timers. Page 31 also provides a space for you to write your own individual program.
- If no personal program is entered, the heater will operate according to the the default factory settings as shown on the bottom of page 31.

■ Follow the steps below to operate the timers:

- 1** Press the "ON/OFF" button. The "Man"(Manual) and "ON" indicators will come on as well as the preset and room temperatures.

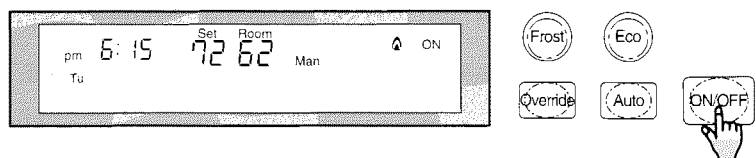

- 2** Press the "Auto" button. The "Man"(Manual) indicator will be replaced by the "Auto"(Automatic) indicator, and the current timer period will show.

If the current period has been programmed with a temperature, the heater will start heating.

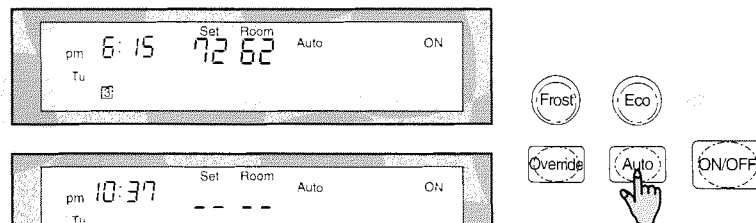

If the current period has been programmed with an OFF setting the heater will not heat during this period.

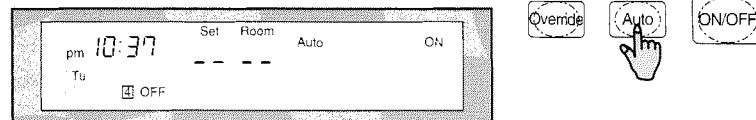

- 3** The heater will now operate according to the four periods programmed into the Weekly Timer.

RETURNING TO MANUAL MODE

- 1** Press the "Auto" button. The "Auto" indicator will go out and be replaced by the "Man"(Manual) indicator. The heater will now heat depending on your manual settings(page 25).

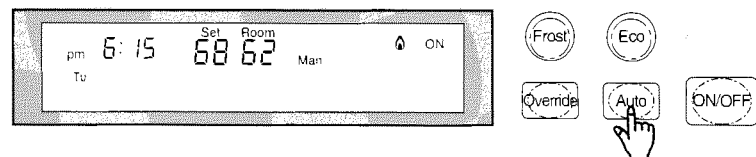

OVERRIDE FUNCTION

- This function is used when the heater is in “Auto” mode(timer operation).
- It allows you to “Override” the preset timer setting until the beginning of the next period.
- For example, if the heater is ON, pressing the “Override” button will turn it OFF until the next period. If the heater is OFF, pressing the “Override” button will turn the heater ON, and allow you to select a temperature, until the next period.

■ To turn on the Override function:

- Remember: The Override function is for use in the “Auto”(timer) mode only.

1

- Press the “Override” button. 
- One of the following will happen depending on the current timer period setting:

If the current timer period is ON (heating)

The heater will turn OFF, the temperatures will display “-”, and the “Override” and “Off” indicators will light.

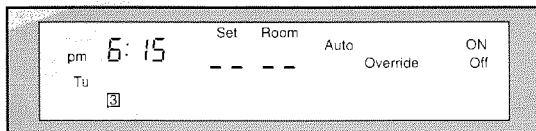

2

- The heater will remain OFF until
 - a. the next timer period, or
 - b. the Override function is turned off manually(see step below).

or

If the current timer period is OFF

The heater will turn ON, the manual pre-set temperature and room temperature will show, and the “Override” and “On” indicators will light.

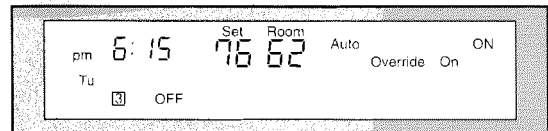

- Press the “▲” or “▼” buttons to manually adjust the pre-set room temperature.

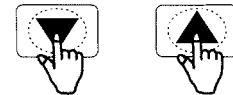

- The heater will remain heating until
 - a. the next timer period, or
 - b. the Override function is turned off manually (see step below).

■ To turn off the Override function:

1

- Press the “Override” button.
- Then the heater will return to the operation of the current timer period.

FROST PROTECTION

- This function allows a minimum room temperature to be pre-set, between 38°F and 60°F. Once the Frost Protection function is selected the appliance will start heating whenever the room temperature falls below the selected temperature, regardless of timer or manual settings.
- In addition this function can be used to protect the elderly or infirm who may suffer from hypothermia.

Follow the steps below to set and operate the Frost Protection:

1 Make sure the heater is turned OFF.

2 Press the “Frost” button. The Frost Protection temperature and the “Frost” indicator will be displayed.

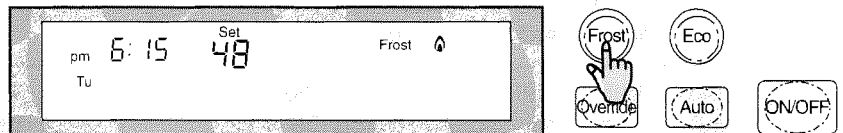

3 Press the “▲” and “▼” buttons to select the Frost Protection temperature. (Between 38°F and 60°F).

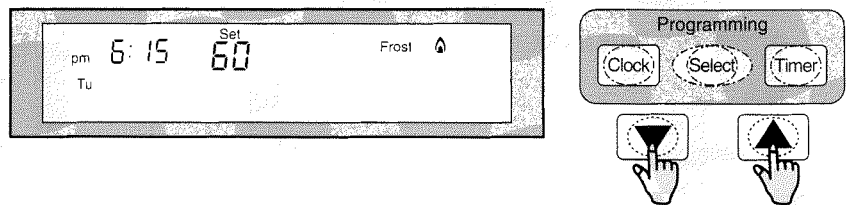

- When the “Frost” indicator is displayed the Frost Protection is operating, and will always prevent the room temperature from falling below the pre-set Frost Protection temperature.

To turn off the Frost Protection:

1 Press the “Frost” button. The “Frost” indicator will go out.

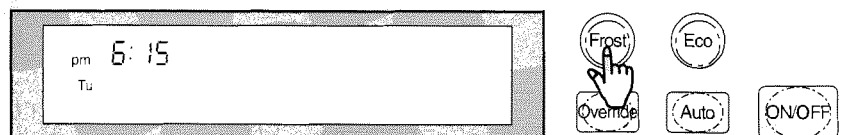

ENERGY SAVING MODE

- The Economy mode can only be set while the heater is operating (heating), but once set it will remain in the system memory until deactivated.

■ To turn on the Economy mode:

Note: The Economy Mode may only be set while the heater is operating(heating).

- 1 Press the “Eco” button. The “Economy Mode” indicator will light.

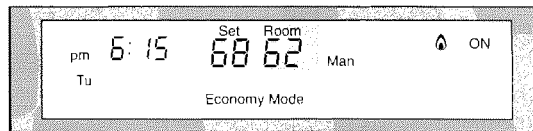

- The Economy Mode now remains in the system memory.
- If the appliance is turned off manually, or stops heating as a result of an OFF timer period, the “Economy Mode” indicator will go out.
- Whenever the appliance starts heating again, the “Economy Mode” indicator will light.

■ To turn off the Economy Mode:

Note: The Economy Mode can only be turned off while the heater is operating(heating), i.e when the “Economy Mode” indicator is showing.

- 1 Press the “Eco” button. The “Economy Mode” indicator will go out.

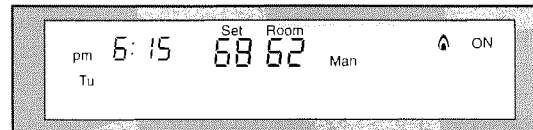

■ Economy Mode: Information

After the room is heated initially the air temperature may be dropped to a lower level without affecting comfort. 30 minutes after the selected room temperature (set manually with the “▲” and “▼” buttons or in an On timer period) is reached, the Economy Mode, if set, reduces the temperature by 2°F. After another 30 minutes it reduces the temperature by a further 2°F, effectively saving energy.

The Economy Mode will not operate if the heater is under capacity for the room size.

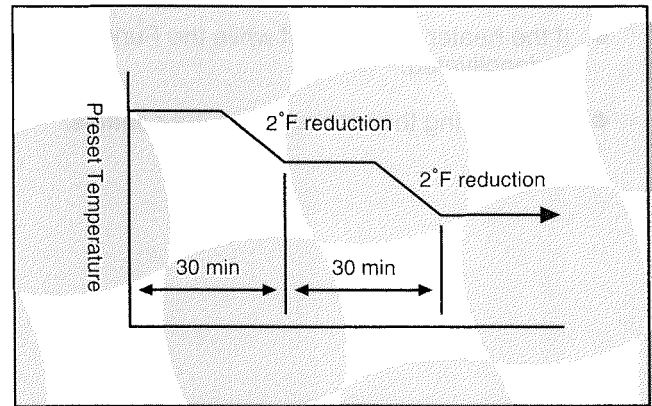

FUNCTION LOCK

- The Function Lock will help to prevent accidental operation of the appliance as well as children from altering the controls.

■ To activate the Function Lock:

- 1 Press the “▲” and “▼” buttons at the same time. The “Function Lock” indicator will light.

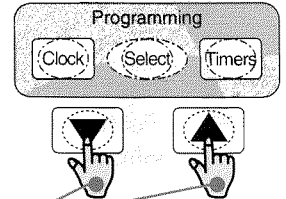
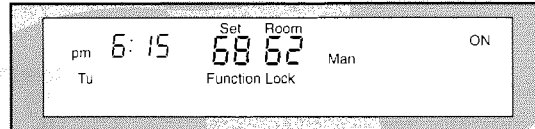

At the same time

■ To deactivate the Function Lock:

- 1 Press the “▲” and “▼” buttons at the same time for approx 2 seconds until a “beep” is heard. The “Function Lock” indicator will go out.

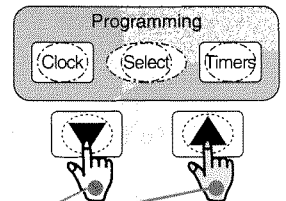
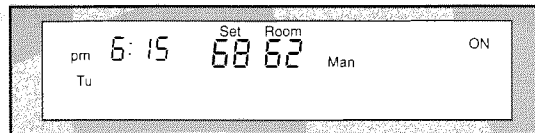

At the same time for 2 seconds

NOTE:

- The lock can be activated when the heater is ON or OFF.
- If activated while the heater is ON, all controls other than the OFF switch will be locked.
- If activated while the heater is OFF, then all controls will be locked.
- If the heater is turned off while the Function Lock is activated, it cannot be turned on again until the lock is deactivated.
- Deactivating the lock releases the controls.

TESTING

Testing Unit

Purge air from gas line.

Refer to pipe sizing chart if in doubt about the size of the gas line.

Connection can easily be reached from the top, rear of the unit. Check for leaks, using soapy water after turning gas on.

Plug unit in and turn power on, (CAUTION - 120V inside unit).

Turn thermostat to "HI", turn control to "ON". Unit should ignite within 10 seconds.

If unit does not ignite, there may be air in the gas line, turn control "OFF" then "ON" again.

Check pressures, regulator is factory set, if pressures are incorrect, check supply before altering regulator. Turn control to "OFF" position, remove pressure manometer and replace test point screws.

Re-light unit, on "HI" setting. Set thermostat to "LO" the heater will cut down, then cut out.

(Depending on the room temperature).

Turn the power off. Replace the casing.

Turn power on.

Re-check operation.

CHECK

Fault-Failure Procedure

If unable to get the unit to operate correctly, contact Rinnai Agent, or Gas Utility. Please read the fault finding charts before reporting faults.

Do not use this heater if any part has been under water. Immediately call a qualified service technician to inspect the heater and to replace any part of the control system and any gas control which has been under water.

"WARNING" Do not operate appliance with the panel(s) removed, cracked or broken.

Installation and repair should be done by a qualified service person. The appliance should be inspected before use and at least annually by a qualified service person.

More frequent cleaning may be required due to excessive lint from carpeting, bedding material, etc.. It is imperative that control compartments, burners and circulating air passageways of the appliance be kept clean. Ventilating system should be inspected and cleaned annually.

Rinnai's service assistance telephone number is 1/800/621—9419.

WARNING: DO NOT OPERATE UNIT UNTIL PROPER INSTALLATION HAS BEEN COMPLETED.

PRE-SERVICE CHECK

Before asking for a service call please check the following points.
These points are part of the normal operation of the unit.

■ At Ignition:

- | | | |
|---|---|---|
| Heater does not operate. | ➔ | Is the heater plugged in?
Have the fuses or breaker blown at the switch board?
Is there a power failure?
Is the air filter blocked?
Is anything blocking the outlet for the hot air?
Is the flue blocked?
Are timers set? Clear timers and operate again. |
| Warm air does not flow when the burner lights. | ➔ | The fan is started automatically after a short delay.
This is to allow the heat exchanger to warm up, helping to avoid cold draughts. |
| Smoke or strange smells are produced on the first trial light up after installation. | ➔ | This is caused by grease or oil and dust on the heat exchanger and will stop after a short time. |
| Sharp clicking noises at ignition, or when unit cuts down on the thermostat, or goes out. | ➔ | This is simply expansion noise from the heat exchanger. |

■ During Combustion:

- | | | |
|---|---|---|
| Clunking noise when the thermostat operates. | ➔ | This is the sound of the solenoid gas valves opening and closing. |
| Unit is not heating room. | ➔ | Is the air filter blocked?
Is the set temperature high enough?
Is the warm air outlet blocked by anything?
Are the doors and windows of the room closed? |
| Air filter is blocked or the louvers are blocked or obstructed. | ➔ | Allow heater to cool, clean air filter, operate again. |
| Heater will not re-ignite after overheating. | ➔ | Even after unit has cooled down the heater does not ignite again. Repair is necessary.
Contact your local agent or Rinnai for a Service call. |

■ When the unit is turned off.

- | | | |
|--|---|--|
| Convection fan continues to run after turning OFF. | ➔ | This is to remove the residual heat from the heat exchanger, the fan will stop when the heater cools down. |
|--|---|--|

■ Other Points:

- | | | |
|---|---|--|
| Steam is discharged from the flue terminal. | ➔ | High efficiency appliances tend to discharge water vapor on cold days, this is normal. |
| Unit cuts off without apparent reason. | ➔ | Check whether filters are blocked, dirty filters will cause the heater of overheat. |
| Power Failure longer than 24 hours. | ➔ | Switch OFF, then ON again when power is restored to re-set controls. |

TROUBLE SHOOTING

Your RHFE-431WTA requires very little maintenance, simply clean the rear fan filter as needed and wipe the outer case and louver section with a damp cloth.

Problem Cause	No ON indicator	Burner doesn't ignite	Unusual combustion	Combustion stops during operation	Smell of gas	Noisy ignition	Takes too long to warm the room	Remedy
Not Plugged In	●	●						Plug In
Power Cut	●	●		●				Re-ignite manually after power is restored
(Initial Installation) Air In Gas Pipe		●						Purge air (Installer)
Gas Filter Blocked		●	●				●	Service Call
Miss Ignition	●	●						Service Call
Flue terminal obstructed			●	●		●		Clear obstruction
Flue manifold not connected						●		Service Call
Louver obstructed				●			●	Clear obstruction
Air filter blocked				●			●	Clean filter
Gas Escape					●			Service Call
Function Lock Set		●						Cancel Function Lock
Gas turned off at meter	●	●						Turn gas on
On Timer is set		●						Cancel "Auto" mode

General maintenance items are not covered under unit's warranty, such as cleaning dust, debris and carbon from flame rod, and improper set up of unit.

ERROR MESSAGES

The Energysaver 431 has the ability to check its own operation continuously. If a fault occurs, an Error Message will flash on the Digital Display of the control panel. This assists with diagnosing the fault, and may enable you to overcome a problem without a service call. Please quote the code displayed when inquiring about service.

CODE DISPLAYED	FAULT	REMEDY
11	Ignition failure	Check gas is turned ON. Service call if repeated.
12	Flame failure	Check gas is turned ON. Service call if repeated.
14	Overheat	Clean filter Service call if repeated.
16	Room overheat	Lower room temperature to less than 40°C(104°F).
31	Room Temperature Sensor faulty	Service call.
32		
33	Overheat Temperature Sensor faulty	Service call.
34		
53	Sparker failure	Service call.
61	Combustion fan failure	Service call.
70	Faulty ON/OFF switch	Service call.
71	Faulty solenoids	Service call.
72	Faulty Flame Rod	Service call.
73	Communication Error	Turn heater OFF, then ON again.
99	Flue block	Check around flue terminal
PF	Power failure longer than 24 hours (During the wait)	Turn heater OFF, then ON again. Set clock and Timers.

In all cases, you may be able to clear the Error Message simply by turning the heater OFF, then ON again. If the Error Message still remains or returns on the next operation, contact Rinnai or your nearest service agent and arrange for a service call.

MAINTENANCE / SERVICE

MAINTENANCE SUGGESTIONS

This heater has been designed and constructed for a long performance life when installed and operated properly under normal conditions. Regular inspections, as outlined in this section, are strongly recommended as means of keeping your heater operating efficiently throughout the season.

1. Cleaning

Heater must be cleaned annually. Keep heater clear of dust and debris especially in and around burner.

Cleaning procedures of heater are as follows:

- 1) Turn heater off. Allow to cool for one hour.
- 2) Remove the Front Panel by removing screws. See parts breakdown on panels.
- 3) Use pressurized air to remove dust from around main burner.
- 4) Use soft dry cloth to wipe cabinet.

DO NOT DAMAGE OR DISTORT ANY PARTS OF HEATER.

DO NOT USE WET CLOTH OR SPRAY CLEANERS ON BURNER.

2. Visual check of main burner flames.

Flame pattern should be as shown in the following Figures.

The burner must flame evenly over the entire surface when operating correctly. The flame must burn with a clear blue stable flame. See parts breakdown of burner for location of view ports. Any and all parts removed for inspection or service must be replaced before operating unit.

3. The appliance area must be kept clear and free from combustible materials, gasoline and other flammable vapors and liquids.
4. The flow of combustion and ventilation air should not be obstructed.
5. Verify proper operation after servicing.

VISUAL CHECK

SATISFACTORY

FRONT VIEW

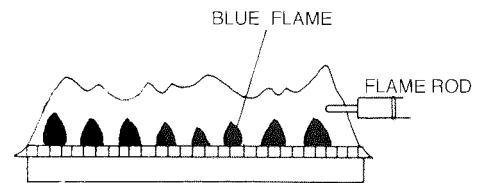

UNSATISFACTORY

FRONT VIEW

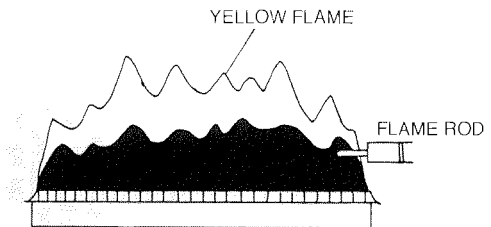

- VENT MAINTENANCE
- VENT SYSTEM
Must be checked annually for blockage or deterioration. See vent installation instructions.
- MAINTENANCE-ELECTRIC MOTORS
Motors are permanently lubricated and need no lubrication. Keep fan and motor free of dust and dirt. Clean annually.

WIRING DIAGRAM

CODE	COLOR
bk	black
bl	blue
br	brown
gr	green
gr/y	green/yellow
pl	purple
r	red
w	white
y	yellow
gy	gray
or	orange

MARK	PART NAME
TB	TERMINAL BLOCK
TH	THERMISTOR
TF	THERMAL FUSE
F	FUSE
ER	ELECTRODE
POV	MODULATING SOLENOID VALVE
TR	TRANSFORMER
FR	FLAME ROD
OH,TH	OVERHEAT THERMISTOR
OHS1-3	OVERHEAT SWITCH 1-3
FM	CONVECTION FAN MOTOR
SP	SPARKER
SV1-2	MAIN SOLENOID VALVE 1-2
BL	COMBUSTION FAN MOTOR

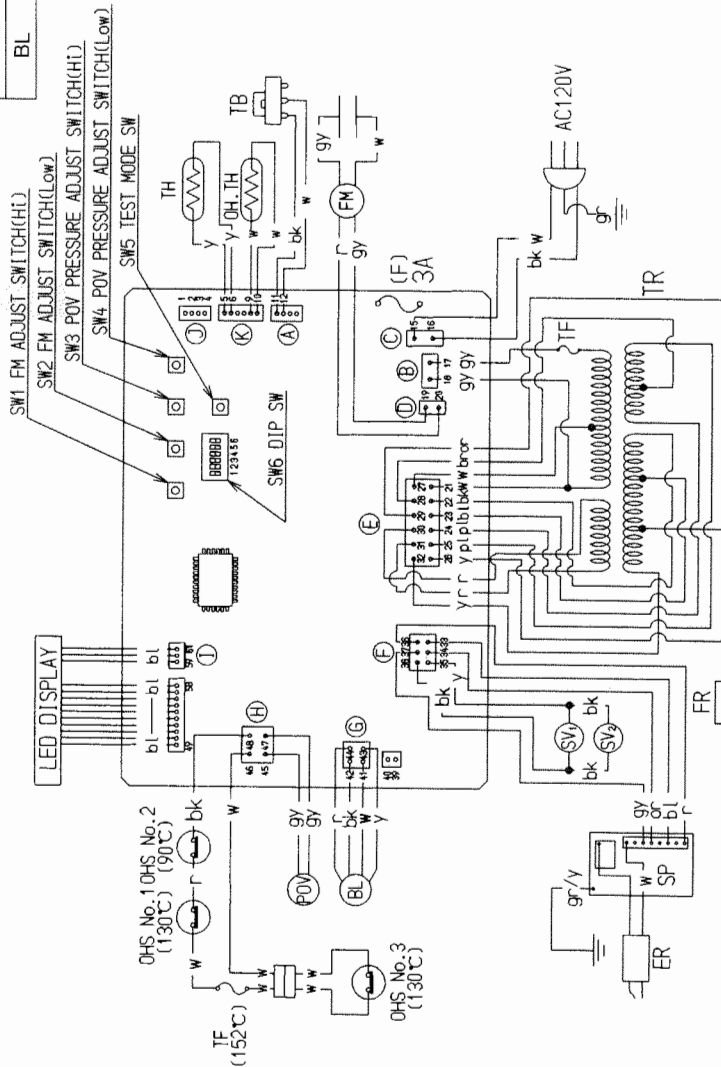

If any of the original wire as supplied with the appliance must be replaced, it must be replaced with a wire of a least a 194°F temperature rating and number 18AWG or its equivalent.

CAUTION: Label all wires prior to disconnection when servicing controls. Wiring errors can cause improper and dangerous operation. Verify operation after servicing.

WARRANTY INFORMATION

Please record below:

Purchased from:

Address:

Phone:

Date of Purchase:

Model No.:

Serial No.:

Installed by:

Installer's license No.:

Address:

Phone:

Date of installation:

The installer is responsible for your heater's correct installation.
Keep in a safe place for your records.

CONSUMER'S NOTICE:

Consumer product safety commission suggest all heating systems should be checked annually to be certain venting system is free of foreign matter, and that safety and electrical component be checked for safe operation. See maintenance.

LIMITED WARRANTY RINNAI FURNACE

Rinnai America corporation warrants the products described in this warranty, including any parts and components thereof, to be free from any defects in materials and workmanship for the period specified below, subject to the terms specified in this warranty. This warranty gives you specific legal rights, and you may also have other rights which vary from state to state or country. This warranty extends to the original purchaser and applies to products purchased and retained for use within the U.S.A and Canada. This warranty applies to furnaces manufactured after June 1, 1995.

MODEL	PERIOD OF COVERAGE	TYPE OF FAILURE
RHFE-431WTA	10 YEARS LIMITED*	DEFECTIVE
	FROM DATE OF PURCHASE	HEAT EXCHANGER
RHFE-431WTA	FIVE YEARS FROM DATE OF PURCHASE	DEFECTIVE MATERIALS
	TWO YEARS FROM DATE OF PURCHASE**	DEFECTIVE MATERIALS AND WORKMANSHIP

In the event of a malfunction, operational difficulty or failure of the product, or any parts or components, during the warranty term, resulting from defects in materials or workmanship Rinnai will remedy the malfunction, operational difficulty, or failure. The remedy will consist of repair or replacement of the product (including payment of reasonable shipping costs), or refund of the purchase price, at the option of Rinnai. You may obtain the benefits of warranty coverage by returning the product to a qualified Rinnai servicing agent for the appropriate repair or replacement. All warranty service and/or replacement of parts must be performed for you by a servicing agent which has been qualified by Rinnai or its authorized distributor. Any such warranty replacement or repair shall be subject to the terms and conditions of this warranty for the remainder of the original period of coverage. In order to obtain the name and location of the qualified Rinnai servicing agent closest to you, please write Rinnai at the address shown on the back side of the warranty card or call Rinnai at 1-800-621-9419 in U.S.A. and Canada.

This warranty does not cover travel time or any failure due to, operational difficulty, or malfunction due to accident, abuse, misuse, misapplication, improper installation or improper maintenance or service, or from any cause other than defects in materials or workmanship.

If any part of your Rinnai EnergySaver fails because of a manufacturing defect in material or workmanship within two years from the date of original purchase, Rinnai will furnish without charge the required replacement part, shipping and reasonable labor. In addition for the following three years, Rinnai will furnish without charge, the required replacement parts and shipping costs.

In addition, if the heat exchangers fail because of a manufacturing defect in material or workmanship within the third through the fifth year, from the date of original purchase, Rinnai will furnish without charge replacement heat exchangers, shipping costs included. Related service labor, import duties or custom fees and diagnosis calls are not included.

In addition, if the heat exchangers fail because of a manufacturing defect in material or workmanship within the sixth through tenth year from the date of original purchase, Rinnai will make the following allowances, based on retail cost, toward purchase of replacement heat exchangers. Any local transportation, related service labor, import duties or customs fees and diagnosis calls are not included.

Year of Failure	Allowance
6	\$ 50.00—U.S.A.
7	\$ 40.00—U.S.A.
8	\$ 30.00—U.S.A.
9	\$ 20.00—U.S.A.
10	\$ 10.00—U.S.A.

Any implied warranties of merchantability and fitness applicable to the equipment are limited in duration to the period of coverage of this express written warranty. Some states/provinces do not allow limitations on how long an implied warranty lasts, so this limitation may not apply to you. Rinnai is not liable for any special, indirect or consequential damages; some states/provinces do not allow the exclusion or limitation of incidental or consequential damages, so this limitation or exclusion may not apply to you.

Rinnai does not authorize any person or company to assume for it any other obligation or liability in connection with the sale, application, engineering, installation, use, removal, return, or replacement of its products; and no such representations are binding on Rinnai. The Warranty Registration Card provided below should be returned within two weeks of purchase to help Rinnai better serve you. However, the return of the Registration Card is not necessary in order to validate this warranty. Proof of purchase with date and serial number is required.

**Effective 1993, the labor warranty may be extended 3 additional years for a total of 5 years full warranty. Mail \$ 25.00 per year to Rinnai with the completed warranty card below.

**FOR EXTENDED WARRANTY - PLEASE REMIT PAYMENT WITH THIS CARD
PLEASE RETURN THIS CARD TO RINNAI WITHIN TWO WEEKS OF PURCHASE**

SCHEMATIC DIAGRAM

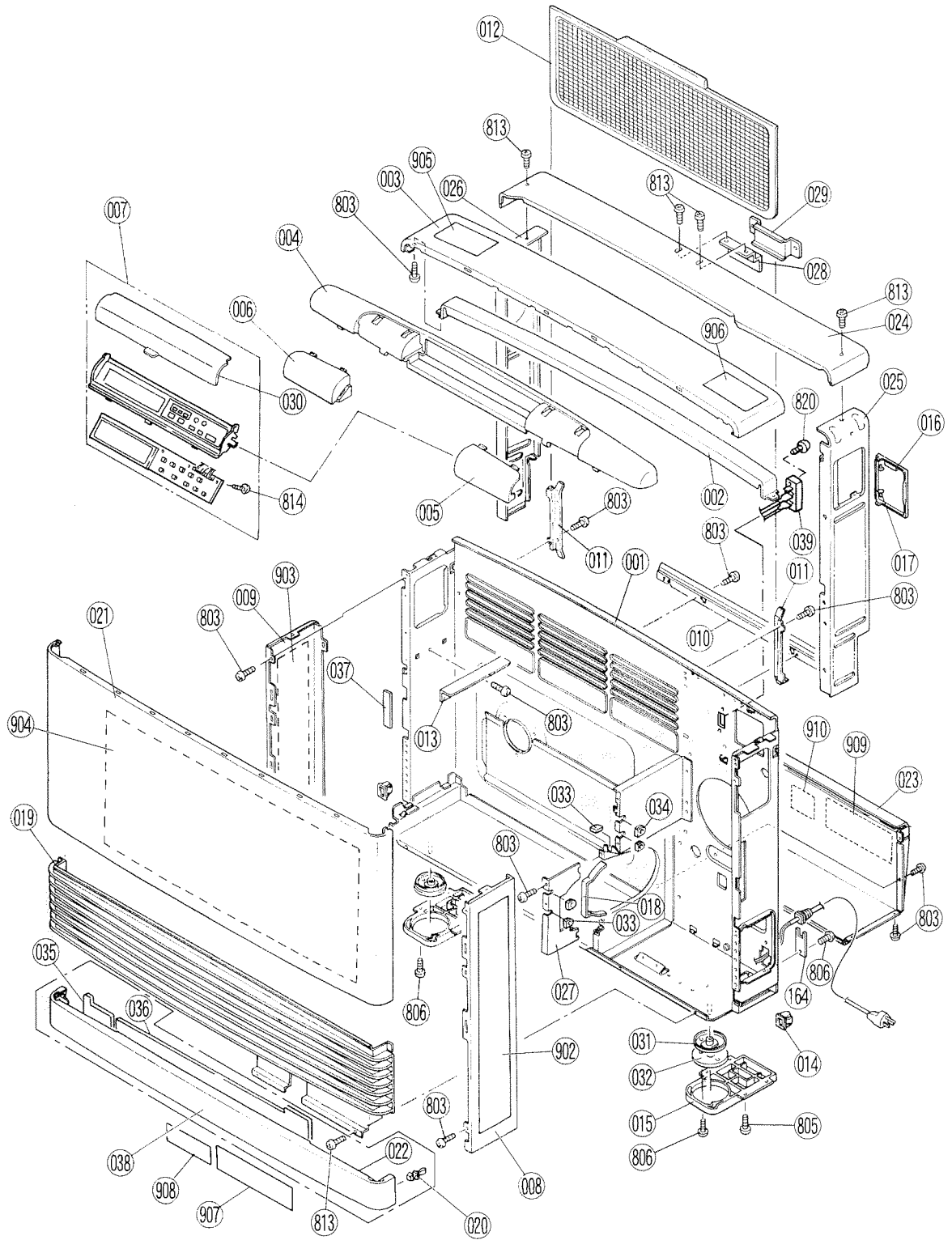

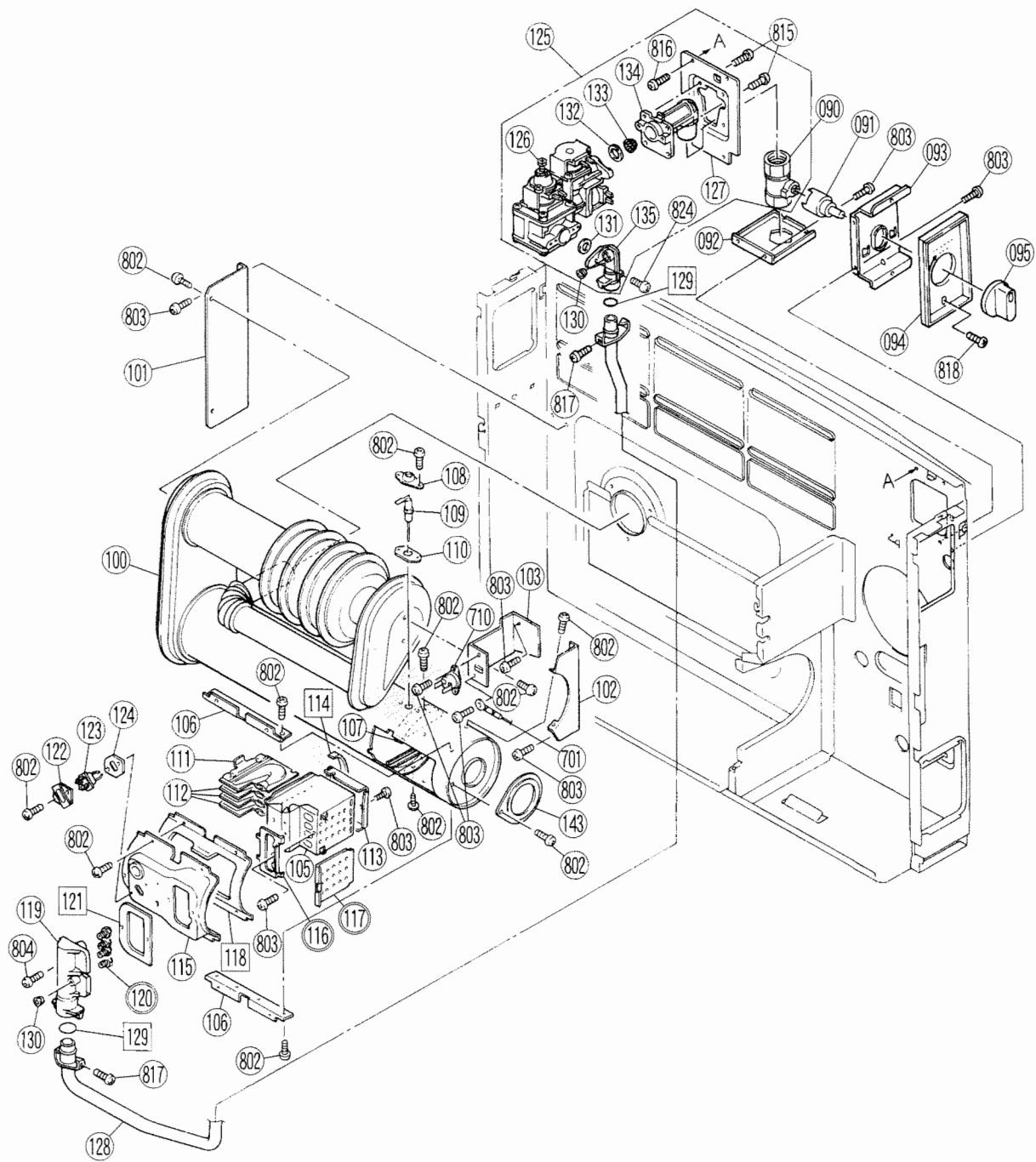

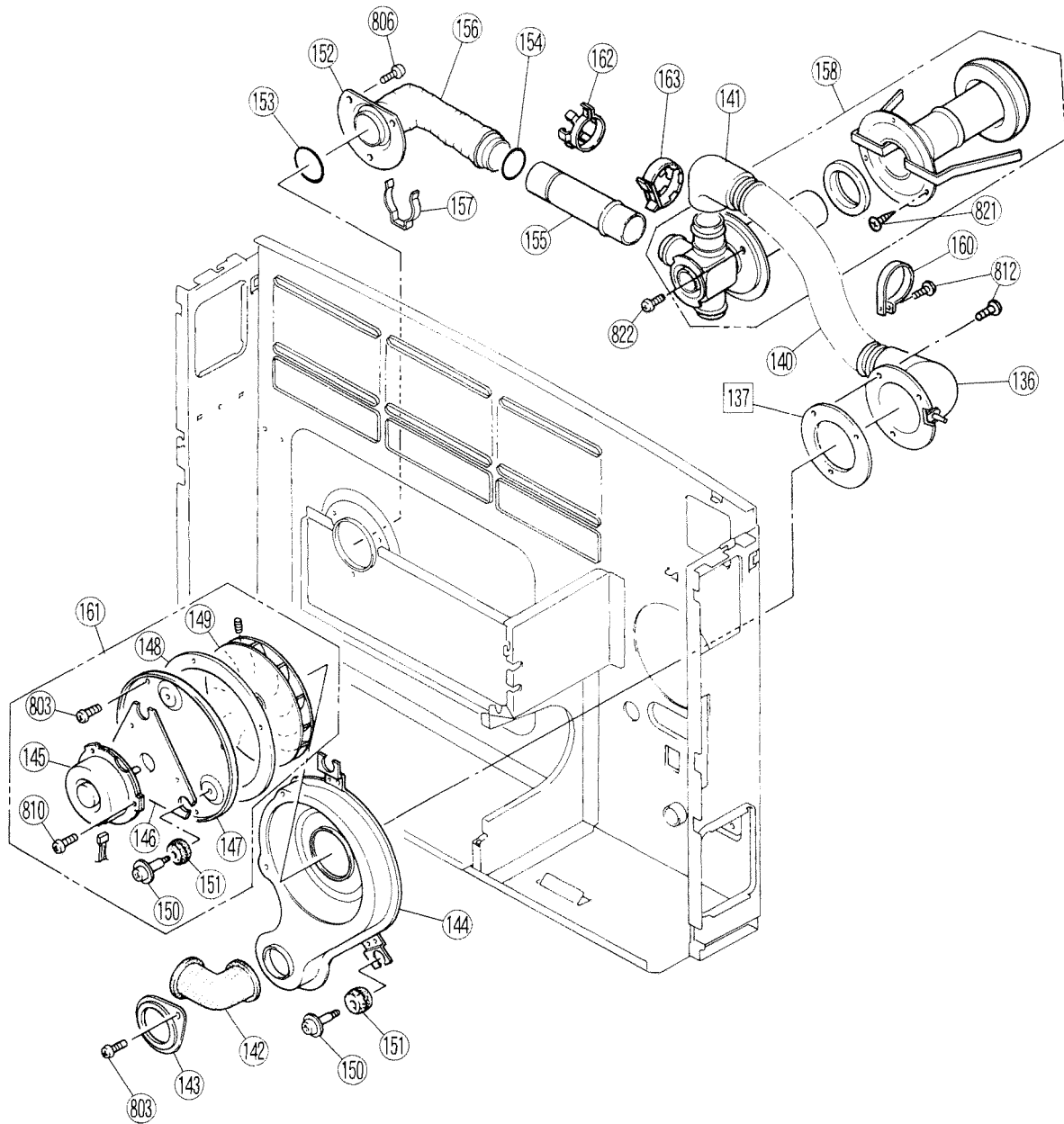

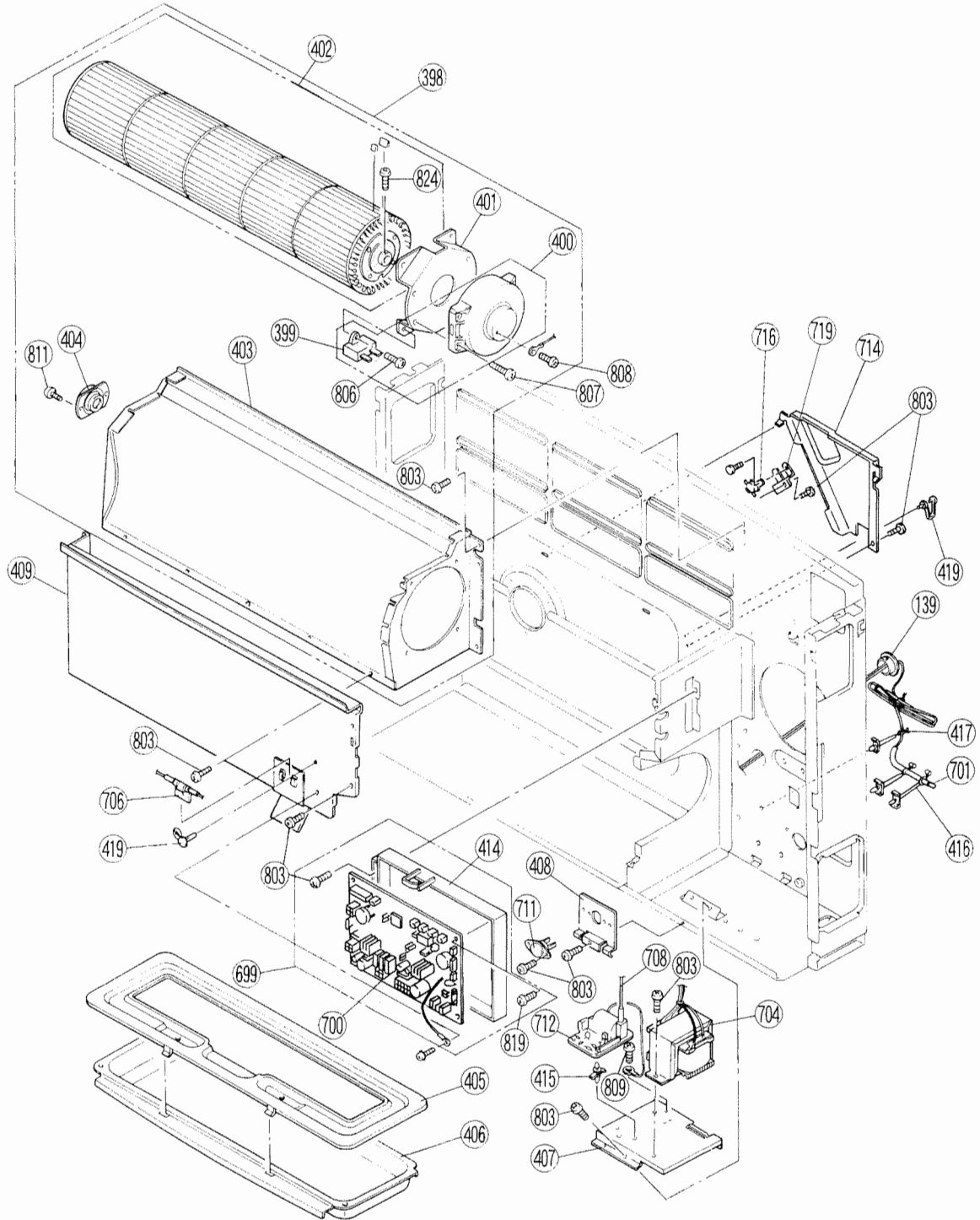

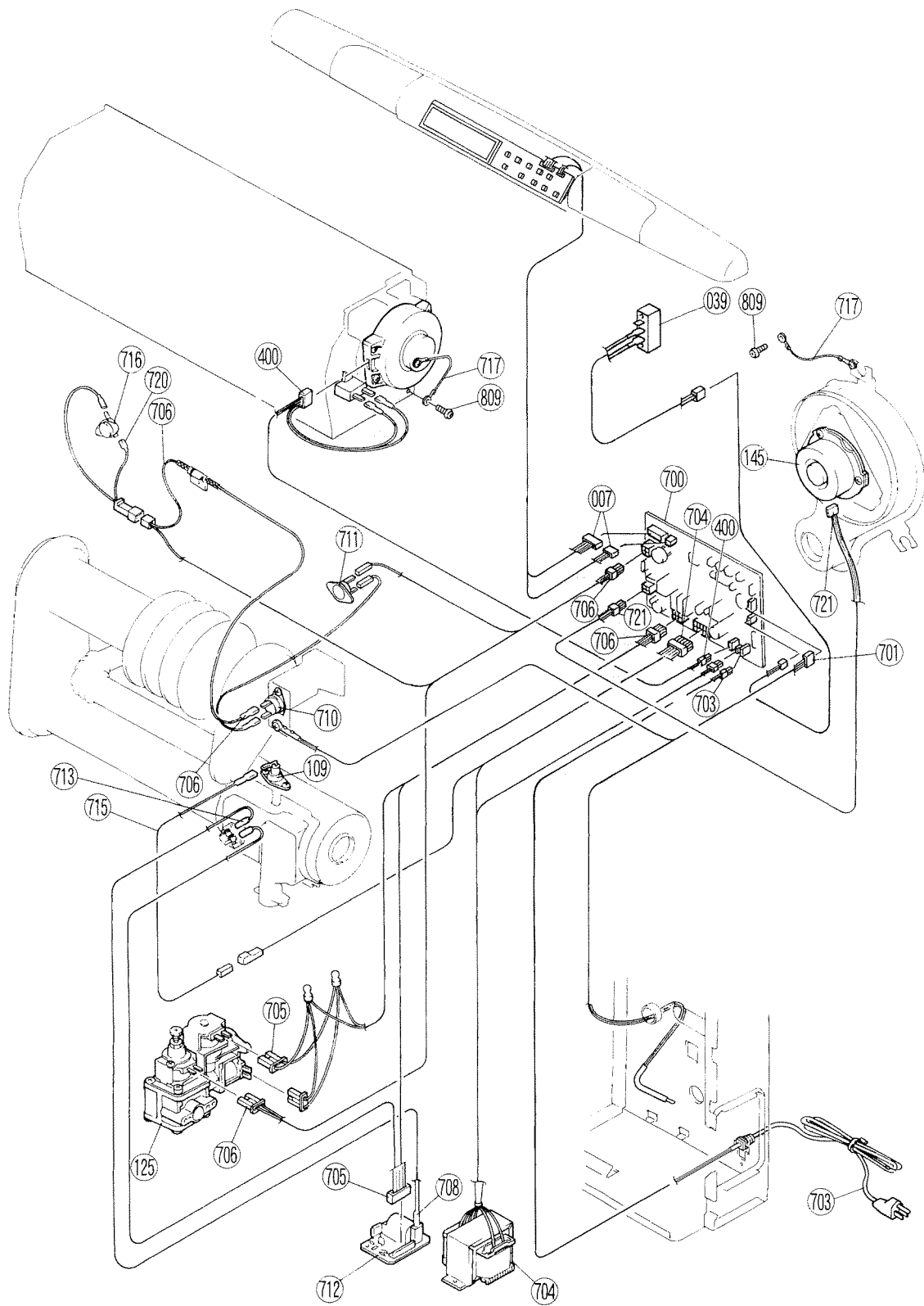

PARTS LIST

No.	PART NAME	PART No.	QTY	REMARKS
001	REAR PANEL ASS'Y	556F-311-4	1	
002	TOP PLATE SUPPORTER	556F-480	1	
003	TOP PLATE	556F-469-2	1	
004	DECORATING FRONT PANEL	556F-467-2	1	
005	DECORATING FRONT PANEL(R)	556F-475-2	1	
006	DECORATING FRONT PANEL(L)	556F-476B-9	1	
007	CONTROL P.C.B ASS'Y	556F-1100	(1)	
008	SIDE PANEL(R)	556F-456-2-B	1	
009	SIDE PANEL(L)	556F-456-1-B	1	
010	AIR FILTER SUPPORTER	556F-312	1	
011	AIR FILTER SUPPORTER(SIDE)	556F-313	2	
012	AIR FILTER ASS'Y	556F-462-2	1	
013	SUPPORT BOARD TO FAN	556F-314	1	
014	LATCH	CP-90380	2	
015	LEG	556F-464	2	
016	CONTROL LID	431F-1320-1	1	
017	NYLON RIVET	550F-0418	2	
018	HEAT EXCHANGER PACKING	554F-421-2	1	
019	LOUVER ASS'Y	556F-472-2	1	
020	STRIKE	CP-90379	2	
021	FRONT PANEL	556F-470-3	1	
022	UNDER COVER ASS'Y	556F-479-2	1	
023	HEAT SHIELD PANEL	556F-321	1	
024	BACK SPACER TOP	556F-457-3	1	
025	BACK SPACER(R)	431F-1310	1	
026	BACK SPACER(L)	431F-1330-1	1	
027	WARM AIR SEAL PANEL	556F-305	1	
028	WALL BRACKET	304F-9077	1	
029	SPACER BRACKET	RHF300-152	1	
030	OPERATION BOX LID	556F-471	1	
031	LEG FIXING BOARD	550F-0220	2	
032	RUBBER LEG	550F-0225	2	
033	CORD PACKING B	AU131-236-b	3	
034	CORD PACKING A	AU131-236-a	2	
035	HEAT INSULATOR A	556F-477	1	
036	HEAT INSULATOR B	556F-478	1	
037	REAR PANEL PACKING	556F-325	1	

No.	PART NAME	PART No.	QTY	REMARKS
038	UNDER COVER TOTAL ASS'Y	556F-479-2	1	
040	TERMINAL BLOCK	431F-1481	1	
090	MANUAL VALVE	1001F-1633	1	
091	KNOB ADAPTOR	431F-1080	1	
092	VALVE REINFOCEMENT BOARD	431F-1050	1	
093	PANEL FITTING PLATE	431F-1040	1	
094	VALVE PANEL	431F-1030	1	
095	VALVE KNOB	CP-40369-24	1	
100	HEAT EXCHANGER ASS'Y	431F-130-2	1	
101	FIXING PLATE	556F-214	1	
102	COMBUSTION CHAMBER FIXER	556F-215	1	
103	OHS FIXER	556F-216	1	
105	BURNER BOX ASS'Y	431F-1094	1	
106	FLANGE	556F-131	2	
107	SEAL PLATE	556F-2032	2	
108	ELECTRODE PLATE	RHF250-038	1	
109	FLAME ROD	1001F-104-4	1	
110	FLAME ROD PACKING	554F-148	1	
111	BURNER ASS'Y C	431F-1091-2	(1)	NG, LPG
112	BURNER ASS'Y	B3A2-4	(3)	NG, LPG
113	BURNER SUPPORTER ASS'Y	556F-225	1	
114	BURNER BOX PACKING	556F-211	1	
115	BURNER BOX FITTING PLATE	556F-224	1	
116(1)	DAMPER	556F-209-15	1	LPG
116(2)	DAMPER	556F-209-7	1	NG
117(1)	SECONDARY AIR DAMPER	556F-208-5	1	LPG
117(2)	SECONDARY AIR DAMPER	556F-208-7	1	NG
118	PACKING	556F-210	1	
119	MANIFOLD	556F-202-2	1	
120	INJECTOR	AU129-210 ^{-0.85} _{-1.13}	4	LPG NG
121	MANIFOLD PACKING	556F-203	1	
122	ELECTRODE MOUNTING PLATE	554F-114	1	
123	ELECTRODE	556F-510	1	
124	ELECTRODE PACKING	554F-147	1	
125(1)	GAS CONTROL TOTAL ASS'Y A	PC-1111-2-A	1	LPG
125(2)	// C	PC-1111-2-C	1	NG

No.	PART NAME	PART No.	QTY	REMARKS
126	GAS CONTROL ASS'Y	C36D-3-6-S	1	
127	INLET REINFORCEMENT BOARD	431F-1060	1	
128	INTER CONNECTION ASS'Y	431F-1150	1	
129	O RING	M10B-1-14	2	
130	BLIND SCREW	AU39-965	2	
131	PACKING	M10B-13-14	1	
132	PACKING	C3I1-7	1	
133	GAS FILTER	RCK-6808	1	
134	GAS INLET	431F-1110	1	
135	OUTLET D	554F-220-4	1	
136	AIR INLET	553F-340-3	1	
137	AIR INLET PACKING	RHF300F-79	1	
139	BUSHING	CP-90326	1	
140	FLEXIBLE HOSE	RHF300-51-10	1	
141	AIR INLET ELBOW	RHF300-52	1	
142	CONNECTING TUBE	556F-404	1	
143	CONNECTING TUBE FIXER	556F-408	2	
144	COMBUSTION FAN CASING ASS'Y	556F-414-1	1	
145	COMBUSTION FAN MOTOR	431F-1210	1	
146	MOTOR MOUNTING PANEL	554F-601	1	
147	LID	554F-604	1	
148	LID PACKING	554F-618	1	
149	COMBUSTION FAN	554F-608	1	
150	SCREW FOR MOTOR	CP-30310	6	
151	CUSHION RUBBER	308F-8273	6	
152	FLUE SLIDING TUBE ASS'Y	302F-1102	1	
153	O RING E	RHF300-200-e	1	
154	O RING D	FOT-001-016-3	1	
155	SLIDING TUBE	RHF250-148-2	1	
156	COVER	302F-1103	1	
157	RING	302F-1206	1	
158	VENT ASS'Y	431F-1900	1	
160	CLAMP	CP-90378	2	
161	COMBUSTION FAN TOTAL ASS'Y	431F-1200	1	
162	PIPE STOPPER F	305F-0013	1	
163	PIPE STOPPER C	305F-0017	1	
164	POWER SUPPLY CABLE BRACKET	RC-329-1033	1	BLACK

No.	PART NAME	PART No.	QTY	REMARKS
398	CONVECTION FAN TOTAL ASS'Y	431F-1500	1	
399	CONDENSOR	556F-259-2	1	3 μ F
400	CONVECTION MOTOR	431F-1510	1	
401	MOTOR BASE	556F-256	1	
402	CONVECTION FAN	556F-258	1	
403	FAN CASING ASS'Y	556F-257-2	1	
404	BEARING	RC-223-74	1	
405	HUMIDIFIER TRAY LID	556F-310	1	
406	HUMIDIFIER TRAY	556F-309	1	
407	IGNITER FIXER	556F-412	1	
408	OHS FITTING PLATE	556F-522	1	
409	HEAT SHIELD BOARD ASS'Y	556F-322	1	
414	P.C.B FITTING PLATE	556F-407	1	
415	CIRCUIT BOARD SPACER	CP-90436-3	4	
416	CABLE CLIP	CP-90125-2	3	
418	WIRE CLIP	CP-90107-2	3	
419	CLAMP	CP-90077-3	5	
699	P.C BOARD TOTAL ASS'Y	556F-2054	1	
700	P.C BOARD	ED-228	1	
701	THERMISTOR	556F-1021	1	
703	POWER SUPPLY CORD	CP-90466-2	1	
704	TRANSFORMER	ET-240	1	
705	MV HARNESS	431F-1400	1	
706	WIRE HARNESS	431F-1410	1	
708	HIGH TENSION CORD	431F-1460	1	
710	OVERHEAT SWITCH	ES-01171	1	266° F OFF
711	OVERHEAT SWITCH	ES-01170	1	194° F OFF
712	IGNITER	EI-161	1	
713	SLEEVE	3022-0344	1	

No.	PART NAME	PART No.	QTY	REMARKS
714	TF COVER	556F-524	1	
715	FR LEAD	431F-1430	1	
716	OVERHEAT SWITCH	ES-01174	1	266°F OFF
717	EARTH LEAD	550F-0818	2	
719	OHS3 BRACKET	556F-570	1	
720	OHS3 LEAD	556F-571	1	
721	MOTOR LEAD	431F-1220	1	
801	SCREW	ZAA0420SZ		
802	SCREW	ZEAB0408UK		
803	SCREW	ZEAB0408SZ		
804	SCREW	ZEDB0412SZ		
805	SCREW	ZEAB0410SZ		
806	SCREW	ZEDB0408SZ		
807	SCREW	ZEDB0416SZ		
808	SCREW	ZHAE0306SZ		
809	SCREW	CP-30421-1		
810	SCREW	ZDAA0410SZ		
811	SCREW	ZEAB0406SZ		
812	SCREW	ZEDB0410SZ		
813	SCREW	ZEAB0408SC		
814	SCREW	ZGAA2.608SZ		
815	SCREW	ZAA0422SZ		
816	SCREW	ZBA0410SZ		
817	SCREW	ZHAA0406SZ		
818	SCREW	ZEDB0408SC		
819	SCREW	CP-30486-2		
820	SCREW	ZEAB0414SZ		
821	SCREW	CP-30408		
822	SCREW	ZBB0410SC		
823	SCREW	ZAA0408SZ		
824	SCREW	ZHAA0410SZ		
900	CONVERSION KIT FOR L.P.G	431F-1004-3	1	
901	CONVERSION KIT FOR N.G.	431F-1004-4	1	
902	RATING PLATE	CP-72135 ⁻¹⁷ / ₋₁₈	1	LPG NG
903	RATING PLATE	CP-72151 ⁻¹⁷ / ₋₁₈	1	LPG NG
904	OPERATION LABEL	556F-2055	1	
905	FILTEL LABEL	1001F-1651	1	
906	CAUTION LABEL	431F-1830	1	
907	CAUTION LABEL	556F-2065	1	
908	CAUTION LABEL	1001F-1656	1	
909	STICKER	431F-1840 431F-1841	1 1	LPG NG
910	CAUTION LABEL	1001F-1654	1	

FLOW DIAGRAM

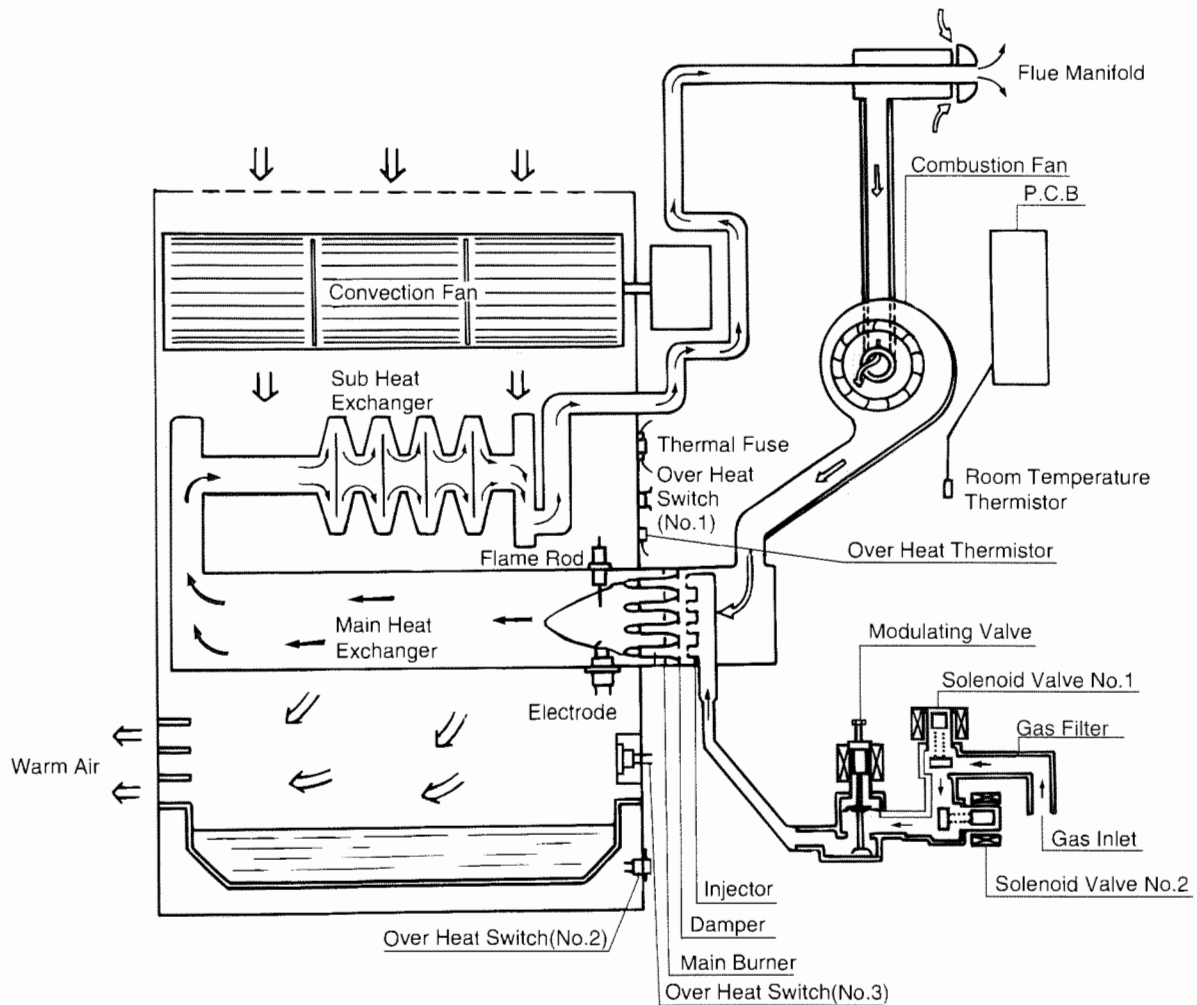

Vent sizes:

5 Vent lengths are available. inch (mm)

- S Vent suits walls 3"~4 1/2" (75~115)
- A Vent suits walls 4 1/2"~9 1/2" (115~240)
- B Vent suits walls 9 1/2"~15 3/4" (240~400)
- C Vent suits walls 15 3/4"~23 5/8" (400~600)
- D Vent suits walls 23 5/8"~31 1/2" (600~800)

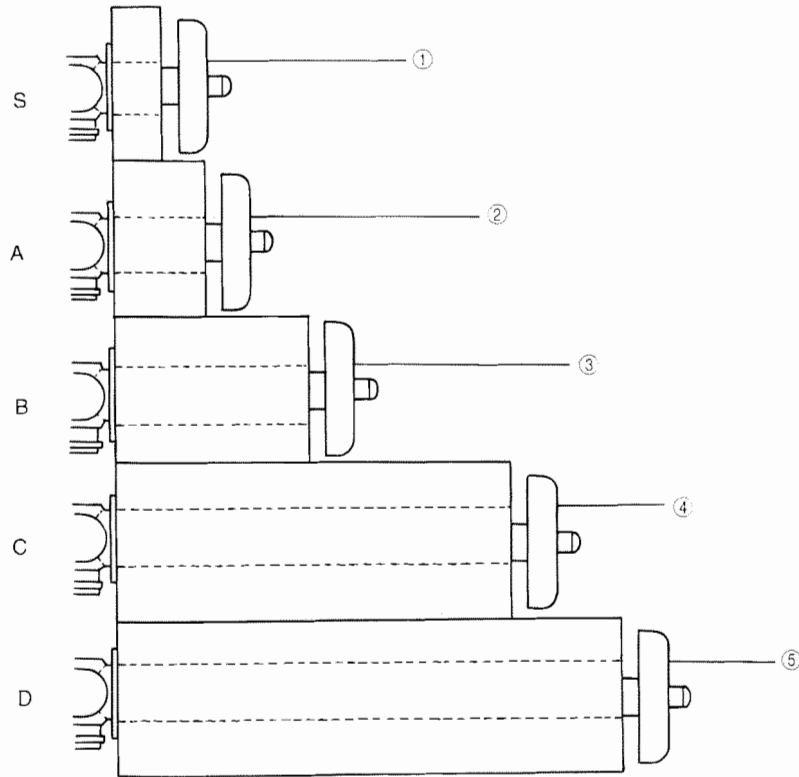

NO.	RANK	PARTS NAME	PARTS NO.	QTY	REMARKS
1	M	VENT KIT - S	FOT-150	1	
2	M	VENT KIT - A	FOT-151	1	
3	M	VENT KIT - B	FOT-152	1	
4	M	VENT KIT - C	FOT-153	1	
5	M	VENT KIT - D	FOT-154	1	
6		RUBBER SEAL		1	SEE PAGE 13.

EXTENSION SET PARTS AND INSTALLATION GUIDE

FOT-155	20"(0.5m)	EXTENSION SET
FOT-156	40"(1m)	EXTENSION SET
FOT-157	80"(2m)	EXTENSION SET
FOT-158		BENT ELBOW SET

Rinnai

- This extension set is to be used for installations requiring extra distance.
MAXIMUM VENT LENGTH 13' WITH 2 ELBOWS

■ NAMES AND NUMBERS OF PARTS

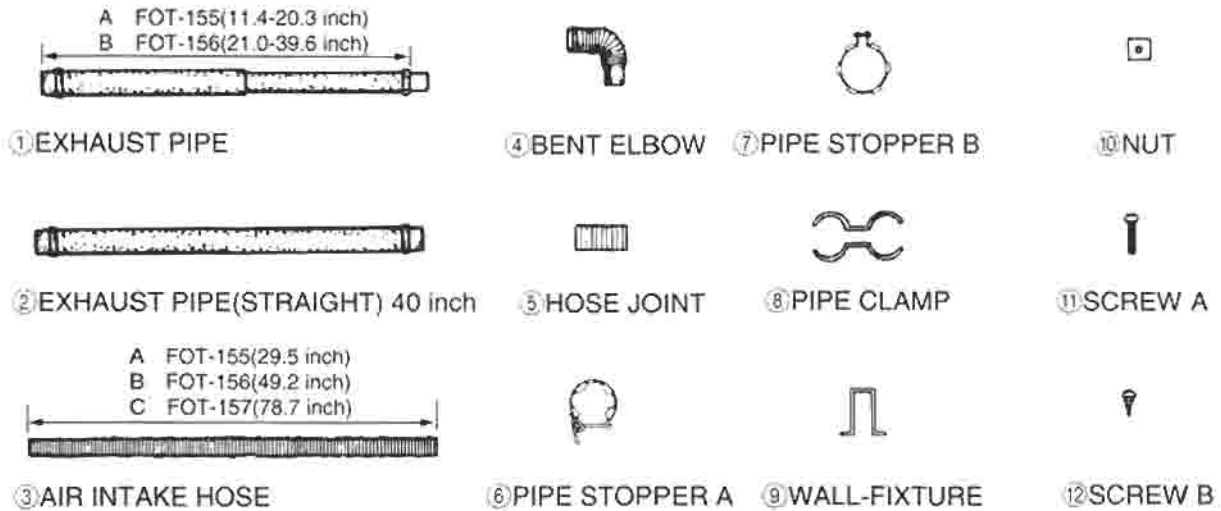

		FOT-155	FOT-156	FOT-157	FOT-158
①	A	EXHAUST PIPE	1		
	B	EXHAUST PIPE		1	1
②		EXHAUST PIPE(STRAIGHT)		1	
③	A	AIR INTAKE HOSE	1		
	B	AIR INTAKE HOSE		1	
	C	AIR INTAKE HOSE			1
④		BENT ELBOW			1
⑤		HOSE JOINT	1	1	1
⑥		PIPE STOPPER A	1	1	2
⑦		PIPE STOPPER B	1	1	1
⑧		PIPE CLAMP	2 SET	3 SET	4 SET
⑨		WALL FIXTURE	2	3	4
⑩		NUT	2	3	4
⑪		SCREW A	2	3	4
⑫		SCREW B	4	6	8

■ TYPES COMPATIBLE WITH EXTENSION SET

INSTALLING AN EXTENSION KIT

Installing an extension kit requires construction of an air line and the exhaust line. The air line is connected between the Air Supply Elbow at the rear of the heater and the air inlet port on the Flue pipe. Similarly, the exhaust line is connected between the joint pipe at the rear of the heater, and the exhaust port on the Flue pipe.

Caution: Check to see there is no debris in pipe or hose.

■ HOW TO INSTALL

Example: Using 2 sets of extension set and 1 bent set.

Example: Using 80 inches slide pipe set.

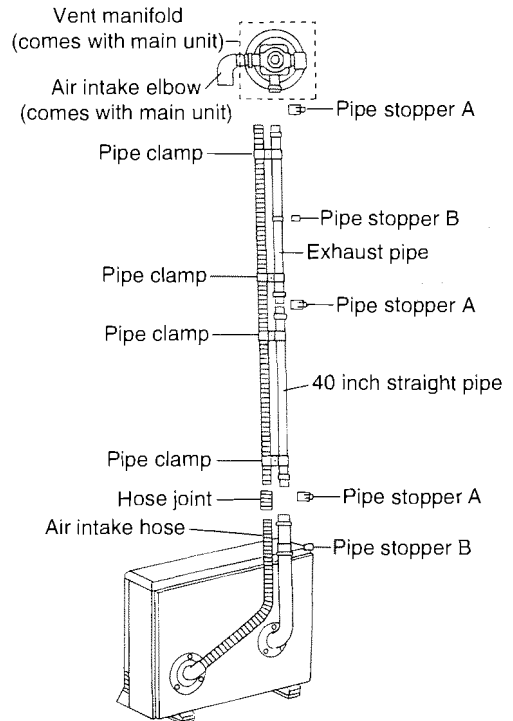
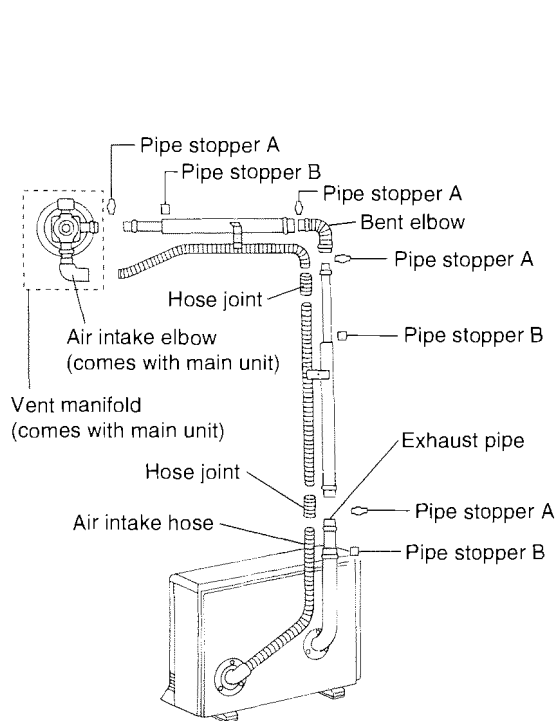

1. How to connect exhaust pipes

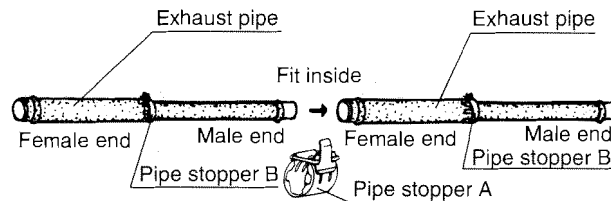

To connect the exhaust pipes, fit the male end into the female end and clamp with pipe stopper A to prevent slipping. The exhaust pipe can be telescoped to the required length; do not cut it.

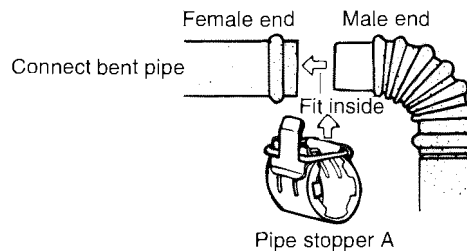

2. How to connect air intake hose

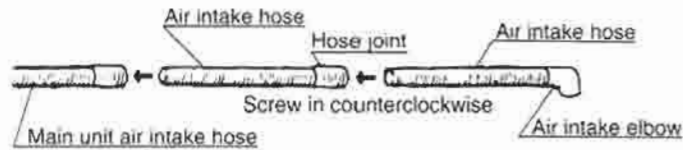

Screw hose joint half of its length onto the air intake hose, then screw another air intake hose into the joint. The hose can be cut to the required length.

IMPORTANT: The PVC air line is longer than the exhaust line and may need to be cut to size. Be sure, however, to thoroughly deburr all rough edges.

3. Affixing the air intake hose and exhaust pipe

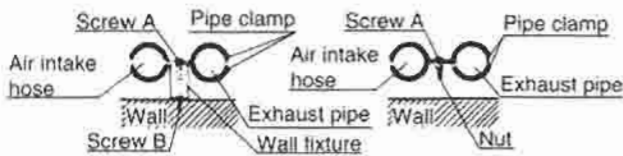

Note: Maintain 1" clearance between exhaust pipe and combustible materials (0" clearance between exhaust pipe and non-combustible materials).

- Set the air intake hose and exhaust pipe into the pipe clamps, screw the clamp onto the wall fixture, and affix to the wall with screw B.
- The air intake hose and exhaust pipe can also be screwed onto the wall using the pipe clamp and the nut.

■ CAUTIONS

1. Maximum extendable length

FOR BEST ROOM AIR HUMIDITY, KEEP WATER IN THE HUMIDIFIER TRAY.

2. To prevent water condensation

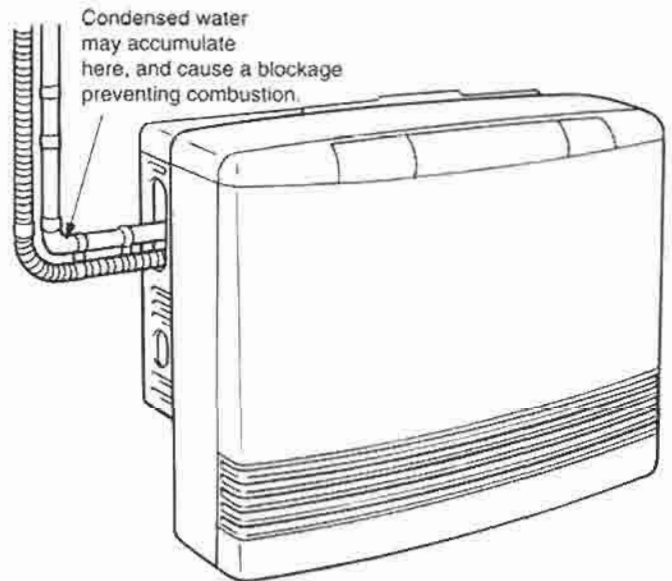

CAUTION

Never allow the exhaust pipe to sag, as condensed water may accumulate and cause incomplete combustion.

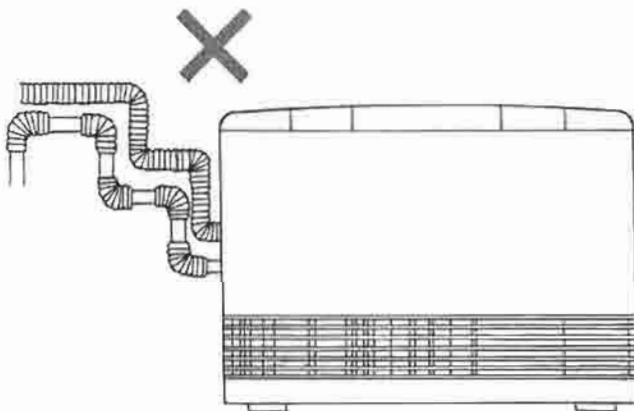

- 13 feet, 2 bends
- The bend where the hose and pipes leave the body is not counted.
- The air intake hose should run along the exhaust pipe.

3. Condensed water formed by combustion, will run back to the unit, and may overflow from the condensation pan if pipes are longer than 8 feet. Therefore, pipes exceeding these lengths should be made to drain to the outside by giving their horizontal portions 3° or more downward and outward slope.

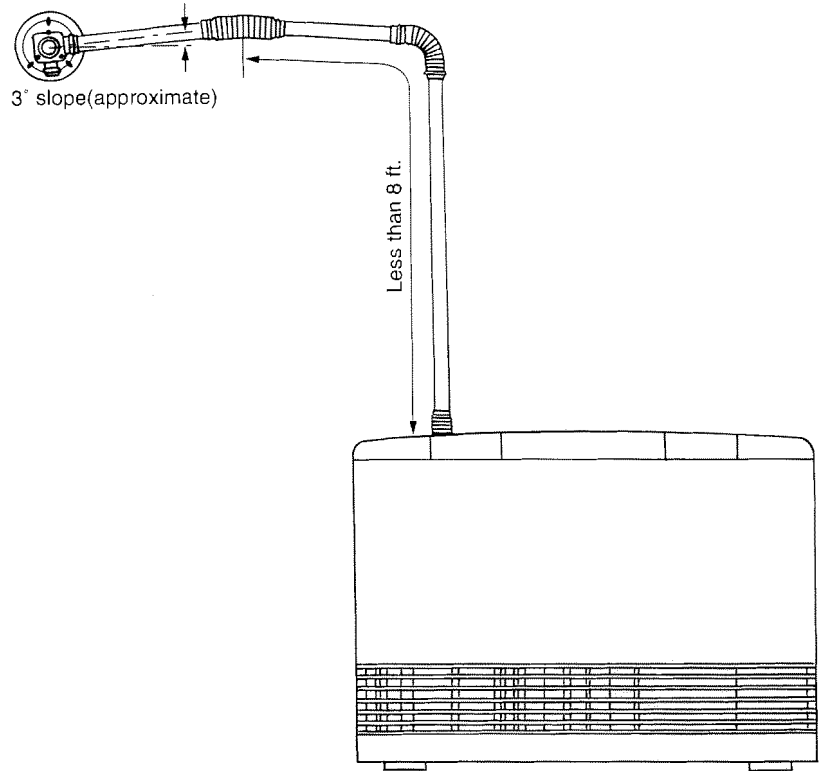

4. Wherever the air intake hose and exhaust pipe run sideways, try to have the exhaust pipe on top (to prevent the air intake hose from sagging onto the exhaust pipe).

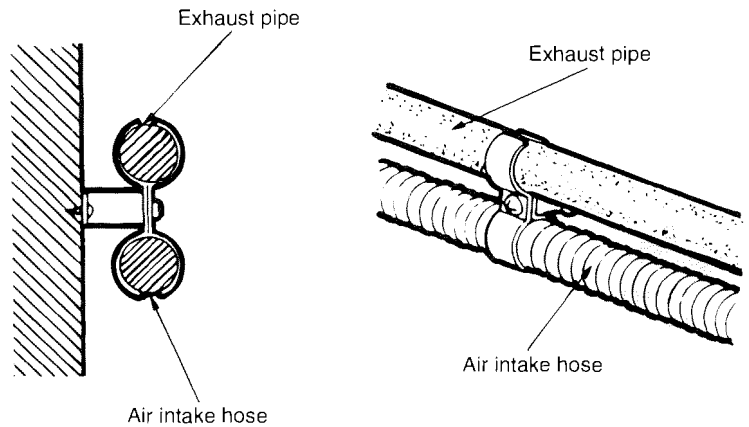

QUALIFIED INSTALLING AGENCY

The installation must conform to local codes, in the absence of local codes, the installation must conform with American National Standard (National Fuel Gas Code) known as NFPA 54 and ANSI Z223.1.1992.

Available from the American National Standards Institute, Inc., 1430 Broadway, New York, N.Y. 10018 or from the National Fire Protection Association, 470 Atlantic Avenue, Boston, Mass. 02210.

NAME TITLE
COMPANY
ADDRESS
CITY STATE ZIP
PHONE NUMBER



NO POSTAGE
NECESSARY
IF MAILED
IN THE
UNITED STATES



BUSINESS REPLY MAIL
FIRST CLASS NO. 118 PEACHTREE CITY, GA

Rinnai America Corp.
103 International Drive
Peachtree City, Georgia 30269
Attn: Furnace Registrar



EXTENDED WARRANTIES ARE AVAILABLE, CONTACT RINNAI FOR DETAILS.

**Rinnai FURNACE
WARRANTY REGISTRATION CARD**

Owner's Name _____
Installation Address _____
City, State, Zip _____
Dealer's Name _____
Address _____
City, State, Zip _____
Type of Dealer _____
Model _____ Type of Gas _____
Serial No. _____
Date Purchased _____
Comments: _____

PLEASE RETURN THIS CARD TO RINNAI WITHIN TWO WEEKS OF PURCHASE

Rinnai

AMERICA CORPORATION

103 International Drive,
Peachtree City, Georgia 30269
Phone:1-800-621-9419
Fax:1-888-474-6624

431F-1720×03(00)

Printed in Japan 2002.9