

## TECHNICAL DATA

| WEIGHT  | DIMENSIONS   | GAS RATE (BTU/h) |        |        |      |        |        |
|---------|--|------------------|--------|--------|------|--------|--------|
|         |  | INPUT            |        | OUTPUT |      |        |        |
| 51 Lbs. | Width: 29 1/2"<br>Height: 21 13/16"<br>Depth: 9 13/16" | NG               | LP     | NG     | LP   |        |        |
|         |  | LOW              | 8,200  | 8,200  | LOW  | 6,640  | 6,640  |
|         |  | HIGH             | 21,500 | 20,700 | HIGH | 17,420 | 16,770 |

### Burner Orifices:

RHFE-556WTA-P use: Orifice part #AU129-210×02-0.85(0.033")

RHFE-556WTA-N use: Orifice part #AU129-210×02-1.13(0.044")

### GAS CONVERSION SPECIFICATIONS

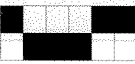
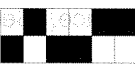
| MODEL       | GAS TYPE | DIAMETER OF ORIFICE(mm) | PRIMARY DAMPER | SECONDARY DAMPER | MANIFOLD DIFFERENTIAL PRESSURE (W.C.) |          | DIP SWITCH POSITION   |
|-------------|----------|-------------------------|----------------|------------------|---------------------------------------|----------|---|
|             |          |                         |                |                  | HI                                    | LO       |   |
| RHFE-556WTA | LPG      | φ 0.85                  | 556F-209-15    | 556F-208-5       | 4.5"W.C.                              | 0.8"W.C. | ON   |
| RHFE-556WTA | NG       | φ 1.13                  | 556F-209-7     | 556F-208-7       | 3.8"W.C.                              | 0.7"W.C. | ON  |

## GAS PRESSURE SETTING PROCEDURE

1. Check and ensure SW6 Dip Switches are correct for the gas type for which the appliance is to be used. (Refer to diagram below.)

|        |     | SW6 DIP SWITCH |     |     |     |    |    |
|--------|-----|----------------|-----|-----|-----|----|----|
| 556WTA | NG  | OFF            | ON  | OFF | OFF | ON | ON |
|        | LPG | ON             | OFF | OFF | OFF | ON | ON |

2. There are two test points, one on the manifold, one on the gas control assembly. Connect pressure gauge to both test points. Using an electronic manometer, connect the ⊖ side to the manifold test point. (Refer to data plate for pressure.)

### GAS SUPPLY PRESSURE

|         | NATURAL   | PROPANE |
|---------|-----------|---------|
| MINIMUM | 5"W.C.    | 8"W.C.  |
| MAXIMUM | 10.5"W.C. | 13"W.C. |

3. Press the ON/OFF button to operate the appliance.
4. With appliance operating, press SW5 once.
5. Press SW4 to operate appliance on forced low. Adjust the setting to the correct pressure using the "▲" and "▼" buttons on the control panel.
6. Press SW4 again to lock in the selected setting.
7. Press SW3 to operate appliance on forced high. Adjust the setting to the correct pressure using the "▲" and "▼" buttons on the control panel.
8. Press SW3 again to lock in the selected setting.
9. Press SW5 once to return heater to normal operation.
10. Press the ON/OFF button to turn the appliance off.
11. Remove the gauge from the test points and replace the test point screws.
12. Test for gas escapes.

- The minimum and maximum inlet gas supply pressures are for the purpose of input adjustment.
- Heaters may be converted from one gas to another using Rinnai conversion kits.
- Output efficiency is 81% of rated input for Canadian installations.

## RHFE-556WTA ENERGYSAVER CONVERSION

AN ELECTRONIC MANOMETER IS A MUST WHEN CONVERTING. We use Kane-May Model #KM-5033. Proper connections are as follows: Connect(1) lead of your manometer to the manifold (item #119) in the parts list. Connect the other lead up to the gas control assembly(item #126) in your parts list. Each of the above items have a 1/8" allen socket head plug in them. The plugs are (item #130) in the parts breakdown. Remember, you are checking differential pressure between the gas control assembly and the manifold. " The conversion shall be carried out in accordance with the requirements of the provincial authorities having jurisdiction and in accordance with the requirements of the CAN1-B149. 1 and 2 installation code." The appliance shall only be converted to a gas for which it has been approved. Conversion kit shall be installed by a qualified service agency. Front panel must be removed to access internal parts. Conversion parts are included in the carton box. " Caution the gas supply shall be shut off prior to disconnecting the electrical power, before proceeding with the conversion." Locate orifices at burner end of gas tubes.

### "WARNING"

"This conversion kit shall be installed by a qualified service agency in accordance with the manufacture's instructions and all applicable codes and requirement of the authority having jurisdiction. If the information in these instructions is not followed exactly, a fire, explosion or production of carbon monoxide may result causing property damage, personal injury or loss of life. The qualified service agency is responsible for the proper installation of this kit. The installation is not proper and complete until the operation of the converted appliance is checked as specified in the manufacture's instructions supplied with the kit."

# RHFE-556WTA CONVERSION

1. Hold both ends of the bottom cover (Undercover ass'y) and pull toward; you to remove the cover. Cover snaps in place. (See Fig. #1)
2. Remove the (6) screws that hold the louver ass'y and (2) screws at the bottom of the front panel to remove panel from the unit. Pull the panel out at the bottom about (4") and lift up over clips that hold it in place at the unit's top. (See Fig. #1 & #2)
3. Remove (1) screw from the overheat switch mounting plate. Place bracket and switch to the side out of your way. (See Fig. #3)
4. Remove the nozzle manifold (2) screws. Then replace all (4) orifices with the proper size for gas type to be used. (See Fig. #3 & #4)  
 Propane gas uses a 0.85mm(0.033") orifice.  
 Natural gas uses a 1.13mm(0.045") orifice.
5. Remove damper inside burner (1) screw, then pull the damper and secondary air damper out and replace with proper size damper. (See Fig. #4)  
 Refer to page #1 under gas conversion for proper damper size to be used for model number being converted.
6. Proper relationship of electrode and flame rod to the burner. (See Fig. #5)
7. Proceed with gas pressure setting.

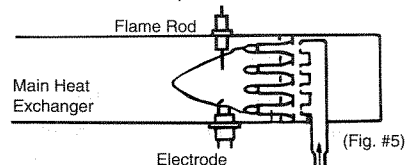
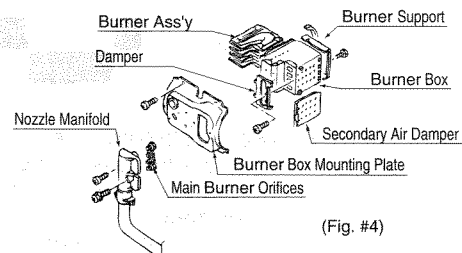
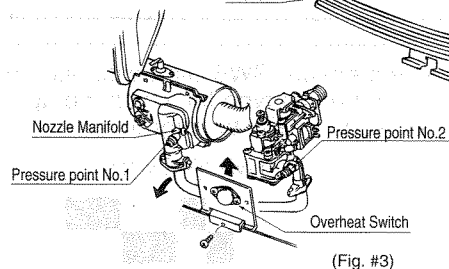
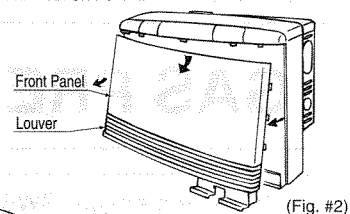
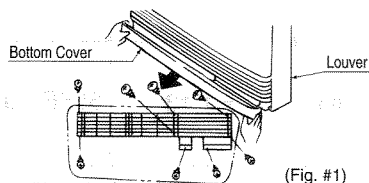

# GAS PRESSURE SETTING AND ADJUSTMENTS

1. Set dip switches (SW6) to the appropriate position for gas type to be used. Proper settings are as follows below from left to right.

Propane gas switch settings are: #1 is ON; #2 is OFF; #3 is OFF; #4 is OFF; #5 is ON; and #6 is ON.  
 Natural gas switch settings are: #1 is OFF; #2 is ON; #3 is OFF; #4 is OFF; #5 is ON; and #6 is ON.

NOTE: See Fig. #8 for test ports and manometer connections. See Fig. #6 for dip switch example.

|        |     | DIP SWITCH SW6 |     |     |     |     |     |
|--------|-----|----------------|-----|-----|-----|-----|-----|
|        |     | 1              | 2   | 3   | 4   | 5   | 6   |
| 556WTA | NG  | ON             | OFF | OFF | OFF | ON  | ON  |
|        | OFF | ON             | ON  | ON  | ON  | OFF | OFF |
|        | LPG | ON             | OFF | OFF | OFF | ON  | ON  |
|        | OFF | ON             | ON  | ON  | ON  | OFF | OFF |

(Fig. #6)

2. To program in gas pressures, follow procedures below. First start unit by pressing the ON/OFF switch. After unit ignites, wait approximately one minute to proceed. Press the (SW5) button to start the programming mode.  
(See Fig. #7)

3. Then press (SW4). This will allow you to set the low pressure differential. The ▼ button will enable you to lower pressure each time button is depressed. The ▲ button will enable you to increase the pressure each time button is depressed. Now by using the arrow buttons, set the low pressure to the correct setting as recommended in the service manual or conversion instructions. (See Fig. #7)

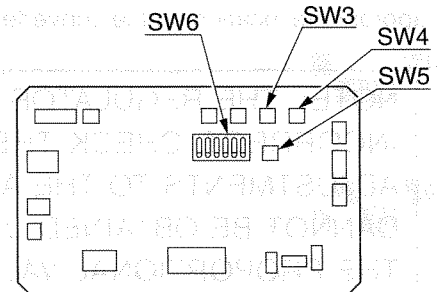

(Fig. #7)

4. To enter your set pressure you will need to press (SW4) button again to "lock-in" the setting. This will finalize the low pressure set up. (See Fig. #7)

**LOW PRESSURE SETTING FOR PROPANE GAS IS 0.8"W.C.; NATURAL GAS IS 0.7"W.C.**

5. Press (SW3) this will allow you to set the high pressure differential. The ▼ button will enable you to lower the pressure each time the button is depressed. The ▲ button will enable you to increase the pressure each time the button is depressed. Now by using the arrow buttons, set the high pressure to the correct setting as recommended in the service manual or conversion instructions. (See Fig. #7)

**HIGH PRESSURE SETTING FOR PROPANE GAS IS 4.5"W.C.; NATURAL GAS IS 3.8"W.C.**

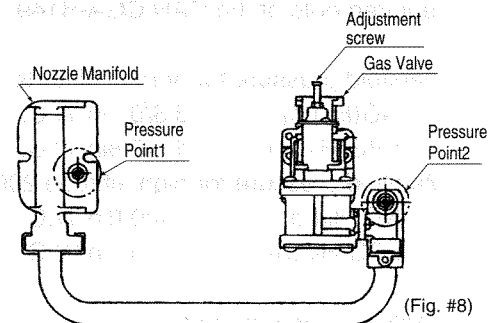

(Fig. #8)

## VISUAL CHECK

6. To enter your set pressure you will need to press (SW3) button again to "lock-in" the setting. This will finalize the high pressure set up. (See Fig. #7)

### SATISFACTORY

7. Press the (SW5) button again to exit the programming mode and return the unit to its normal operating mode. (See Fig. #7)

#### FRONT VIEW

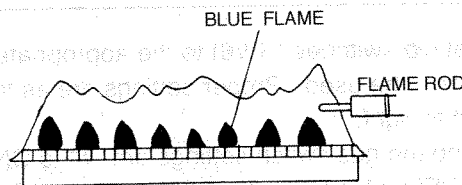

8. After completion of gas pipe connections, all joints including the heater must be checked for gas tightness by means of leak detector solution, soap and water, or an equivalent nonflammable solution, as applicable.

CAUTION: Since some leak test solutions, including soap and water, may cause corrosion or stress cracking, the piping shall be rinsed with water after testing, unless it has been determined that the leak test solution is noncorrosive.

### UNSATISFACTORY

#### FRONT VIEW

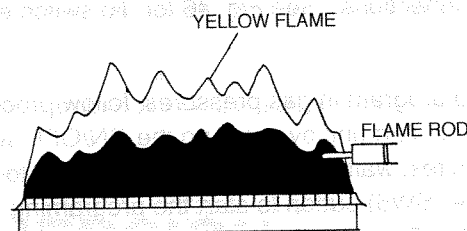

9. Visual check for proper main burner flame appearance.

10. Make sure all markings provided in the kit are in the appropriate location on the converted appliance.

**NOTE: THE REGULATOR HAS BEEN FACTORY PRE-SET. IF THE PRESSURE IS INCORRECT, CHECK THE SUPPLY PRESSURE FIRST, BEFORE MAKING ANY ADJUSTMENTS TO THE APPLIANCE. ALSO, IF THE LOW CONTROL PRESSURE CANNOT BE OBTAINED USING STEP 3, ADJUST THE ADJUSTMENT SCREW ON THE PROPORTIONAL VALVE TO ROUGHLY SET THE DIFFERENTIAL PRESSURE AND THEN FOLLOW STEP 3. SEE FIG#7 FOR LOCATION OF ADJUSTMENT SCREW.**

1. The conversion shall be carried out by a manufacturer's authorized representative. In accordance with the requirements of the manufacturer, provincial or territorial authorities having jurisdiction and in accordance with the requirements of the CAN/CGA-B149.1 or CAN/CGA-B149.2 Installation Codes.

|  |   |
|--|---|
| 2. Manifold pressure for normal altitude 0-2000ft (0-610m):  | Pression du collecteur en altitude normale: |
| NG(Hi/Lo) 3.8/0.7in.W.C.                                     | GN(Max./Min.) 3.8/0.7pouces W.C.            |
| LPG(Hi/Lo) 4.5/0.8in.W.C.                                    | GP(Max./Min.) 4.5/0.8pouces W.C.            |
| Manifold pressure for high altitude 2000-4500ft (610-1370m): | Pression du collecteur en altitude elevee:  |
| NG(Hi/Lo) 3.4/0.6in.W.C.                                     | GN(Max./Min.) 3.4/0.6pouces W.C.            |
| LPG(Hi/Lo) 4.1/0.7in.W.C.                                    | GP(Max./Min.) 4.1/0.7pouces W.C.            |

3. Verify proper input rate by:

① Confirm differential pressure for which gas unit is converted to:

NG 3.8 in. W.C.

LPG 4.5 in. W.C. (Normal altitude)

② Confirm dip switch position:

See page 3 of this manual.

③ Confirm proper orifice size:

NG  $\phi$  1.13mm

LPG  $\phi$  0.85mm

# DONNÉES TECHNIQUES





| POIDS              | DIMENSIONS   | TAUX CALORIFIQUE (BTU/h) |        |              |        |
|--------------------|--|--------------------------|--------|--------------|--------|
|                    |  | ENTRÉE                   |        | SORTIE       |        |
| 51 Lbs.<br>(24 kg) | Largeur: 29 1/2" (750mm)<br>Hauteur: 21 13/16" (554mm)<br>Profondeur: 9 13/16" (250mm) | GN                       | LP     | GN           | LP     |
|                    |  | BASSE 8,200              | 8,200  | BASSE 6,640  | 6,640  |
|                    |  | HAUTE 21,500             | 20,700 | HAUTE 17,420 | 16,770 |

Orifices du brûleur:

RHFE-556WTA-P utilisez pièce # AU129-210×02-0.85(0.033")

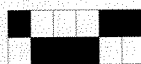

RHFE-556WTA-N utilisez pièce # AU129-210×02-1.13(0.044")

## DONNÉES DE CONVERSION DES GAZ

| MODÈLE      | GAZ | DIAMÈTRE DE L'ORIFICE (mm) | REGISTRE PRIMAIRE | REGISTRE SECONDAIRE    | PRESSION DIFFÉRENTIELLE AU DISTRIBUTEUR (W.C.) |                                 | POSITIONS DES COMMUTATEURS   |
|-------------|-----|----------------------------|-------------------|------------------------|--|---------------------------------|--|
|             |     |                            |                   |                        | HAUTE  | BASSE                           |  |
| RHFE-556WTA | P   | φ 0.85                     | 556F-209-15       | 556F-208-5 (φ 2.5×15)  | 4.5"W.C. (114mmH <sub>2</sub> O)               | 0.8"W.C. (20mmH <sub>2</sub> O) | ON <br>OFF     |
| RHFE-556WTA | GN  | φ 1.13                     | 556F-209-7        | 556F-208-7 (33×47hole) | 3.8"W.C. (96mmH <sub>2</sub> O)                | 0.7"W.C. (18mmH <sub>2</sub> O) | ON <br>OFF  |

# PROCÉDÉ DU RÉGLAGE DES GAZ

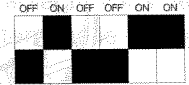
- Assurez-vous que le commutateur SW6 soit réglé pour le type de gaz utilisé (vous référer au tableau ci-bas).

|        |    | COMMUTATEUR SW6   |
|--------|----|---|
| 556WTA | GN |  |
|        | P  |  |

- Il y a deux points de vérification: un sur le distributeur (manifold) et un avec les commandes du gaz. Raccordez un manomètre à chacun des deux points. Si vous utilisez un manomètre électronique, raccordez le côté ⊖ au distributeur (manifold). Veuillez vous référer à la plaquette de données pour connaître la pression désirée.

### PRESSION DE L'ALIMENTATION

|         | GAZ NATURAL       | PROPANE         |
|---------|-------------------|-----------------|
| MINIMUM | 5"W.C. (127mm)    | 8"W.C. (203mm)  |
| MAXIMUM | 10.5"W.C. (267mm) | 13"W.C. (330mm) |

- Pressez le bouton ON/OFF afin de mettre l'appareil en marche.
- Tandis que l'appareil est en marche, pressez SW5 une seule fois.
- Pressez SW4 pour que l'appareil fonctionne à basse intensité. Réglez la pression en utilisant les boutons "∧" et "∨".
- Pressez SW4 une seconde fois afin de conserver le réglage.
- Pressez SW3 pour que l'appareil fonctionne à haute intensité.
- Pressez SW3 de nouveau afin de conserver le réglage.
- Pressez SW5 pour que l'appareil fonctionne à intensité normale.
- Pressez le bouton ON/OFF afin d'arrêter l'appareil.
- Enlevez les manomètres des deux points de vérification et replacez les vis.
- Vérifiez qu'il n'y ait aucune fuite de gaz.

## RHFE-556WTA-CONVERSION AU MODE ÉCONOMIQUE

VOUS DEVEZ UTILISER UN MANOMÈTRE ÉLECTRONIQUE POUR CE GENRE DE CONVERSION. Nous recommandons le modèle KM-5033 de KANE-MAY. La méthode de raccordement est comme suit: raccordez un fil de votre manomètre au distributeur (item #119 de la liste de pièces). Raccordez l'autre fil aux commandes du gaz (item #126 de la liste de pièces). Chacune des pièces énumérées ci-haut comportent une tête ALLEN 1/8" (item #130 de la liste de pièces). Il est important de se souvenir que vous vérifiez la pression différentielle entre le distributeur et les commandes du gaz. La conversion doit être faite en accord avec les règlements provinciaux et d'après le code CAN1-B149, 1 and 2. L'appareil peut seulement être converti pour fonctionner au gaz initialement approuvé. La conversion devra être effectuée par un technicien qualifié. La panneau avant doit être enlevé afin d'avoir accès à l'intérieur de l'appareil. Les pièces nécessaires à la conversion se trouvent dans le compartiment électronique de l'appareil. Vous devez couper le courant et le gaz avant d'effectuer les travaux.

### AVERTISSEMENT

Cet ensemble de conversion ne doit être installé que par le représentant d'un organisme qualifié et conformément aux instructions du fabricant et à tous les codes et exigences applicables de l'autorité compétente. Quiconque ne respecte pas à la lettre les instructions dans le présent manuel risque de déclencher un incendie ou une explosion entraînant des dommages matériels, des lésions corporelles ou la perte de vies humaines. L'organisme qualifié qui effectue les travaux est responsable de la conversion correcte de ce générateur d'air chaud à l'aide de cet ensemble.

## CONVERSION DU RHFE-556WTA

1. Tenez les deux bouts du couvercle inférieur et tirez vers vous afin d'enlever le couvercle. Le couvercle demeurera en position (voir fig. 1).
2. Enlevez les 6 vis de la lucarne et les 2 vis au bas du panneau avant. Relevez le panneau d'à peu près 4" et passez-le au-dessus des attaches qui le tiennent en place (voir fig. 2).
3. Enlevez 1 vis de la plaquette d'installation de l'interrupteur de haute intensité. Placez l'interrupteur hors de votre champ de travail (voir fig. 3).
4. Enlevez le distributeur (2 vis), puis remplacez les 4 orifices afin qu'ils correspondent au gaz à être utilisé (voir fig. 3 & 4).  
Utilisez un orifice de 0.85mm (0.033") pour le gaz propane.  
Utilisez un orifice de 1.13mm (0.045") pour le gaz nat.
5. Enlevez le registre du brûleur (1 vis), puis enlevez le registre primaire et le registre secondaire et remplacez-le avec un registre de grandeur appropriée (voir fig. 4).  
Vous référer à la page 5 afin de déterminer la grandeur requise pour le gaz utilisé.
6. Procédez avec la vérification de la pression du gaz.

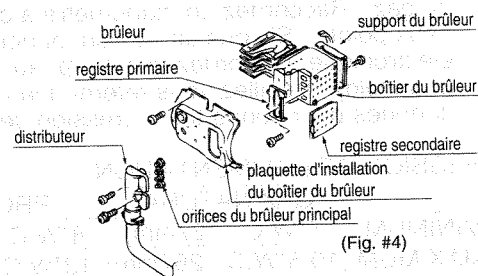
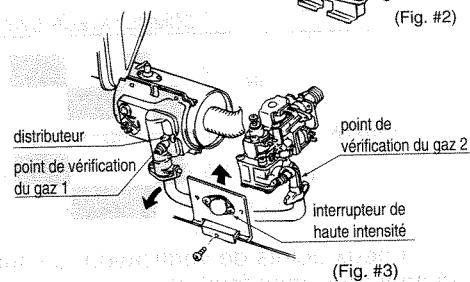
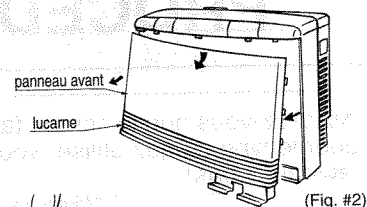
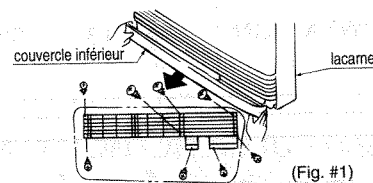

# RÉGLAGE DE LA PRESSION DU GAZ ET ADJUSTMENTS

- Réglez les commutateurs SW6 à la position correspondant au gaz utilisé. Pour le propane (de gauche à droite): #1 ON, #2 OFF, #3 OFF, #4 OFF, #5 ON, #6 ON.  
Pour le gaz naturel, (de gauche à droite): #1 OFF, #2 ON, #3 OFF, #4 OFF, #5 ON, #6 ON.  
NOTE: vous référer à la fig. 7 pour les points de vérification et les connexions de manomètre. Voir fig. 5 pour exemple des réglages des commutateurs.

|        |     | COMMUTATEUR SW6 |   |   |   |   |   |
|--------|-----|-----------------|---|---|---|---|---|
|        |     | 1               | 2 | 3 | 4 | 5 | 6 |
| 556WTA | GN  | ON              | ■ | ■ | ■ | ■ | ■ |
|        | OFF | ■               | ■ | ■ | ■ | ■ | ■ |
|        | P   | ON              | ■ | ■ | ■ | ■ | ■ |
|        | OFF | ■               | ■ | ■ | ■ | ■ | ■ |

(Fig. #5)

- Afin de programmer les pressions du gaz, démarrez l'appareil en pressant le bouton ON/OFF; une fois l'appareil en marche, attendez une minute, puis pressez le bouton SW5 afin de commencer la programmation (voir fig. 6).
- Pressez maintenant le bouton SW4 afin de régler la basse pression différentielle. Le bouton ▼ réduit la pression et le bouton ▲ l'augmente. A l'aide de ces boutons, réglez la pression tel que recommandé dans le manuel d'installation (voir fig. 6).

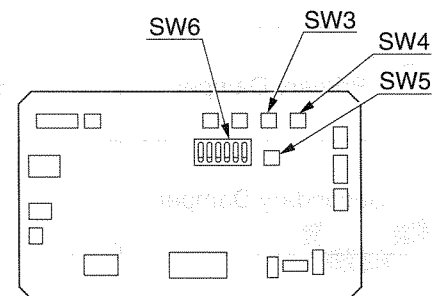

(Fig. #6)

- Afin de conserver votre réglage, vous devez presser le bouton SW4 de nouveau. Ceci termine le réglage de la basse pression différentielle. (voir fig. 6).  
**LE RÉGLAGE À BASSE PRESSION POUR LE PROPANE EST 0.8"W.C. (20mmH<sub>2</sub>O) POUR LE GAZ NAT.: 0.7"W.C. (18mmH<sub>2</sub>O)**

- Pressez le bouton SW3 afin de régler la haute pression différentielle. Le bouton ▼ réduit la pression, et le bouton ▲ l'augmente A l'aide de ces boutons, réglez la pression tel que recommandé dans le manuel d'installation (voir fig. 6).  
**LE RÉGLAGE À HAUTE PRESSION POUR LE PROPANE EST 4.5"W.C. (114mmH<sub>2</sub>O) POUR LE GAZ NAT.: 3.8"W.C. (96mmH<sub>2</sub>O)**

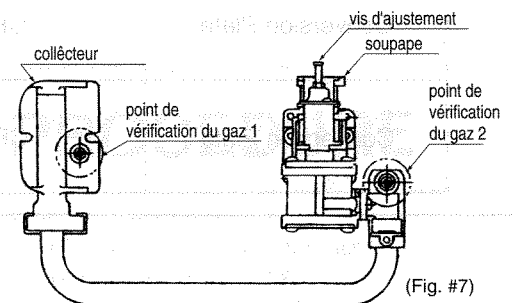





(Fig. #7)

- Afin de conserver votre réglage, vous devez pressez le bouton SW3 de nouveau. Ceci termine le réglage de la haute pression différentielle (voir fig. 6).
- Pressez le bouton SW5 une dernière fois afin de terminer la programmation (voir fig. 6).

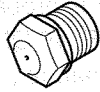
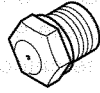
**NOTE: LE RÉGULATEUR A ÉTÉ PRÉ-RÉGLÉ PAR LE MANUFACTURIER. SI LA PRESSION EST INCORRECTE, VÉRIFIEZ LA PRESSION A LA SOURCE AVANT D'EFFECTUER TOUT CHANGEMENT AU NIVEAU DE L'APPAREIL. AUSSI, SI LA BASSE PRESSION DE CONTROLE NE PEUT ETRE OBTENUE EN FAISANT L'ÉTAPE 3, R'ÉGLEZ LA SOUPAPE DE PROPORTION A PEU PRES AU MEME NIVEAU QUE LA PRESSION DIFFÉRENTIELLE, PUIS REFAIRE L'ÉTAPE 3. VOIR FIG. 7 POUR LA LOCALITÉ DE LA VIS D'AJUSTEMENT.**

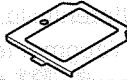
# LIST OF CONVERSION PARTS

| Part Name        | Part No.       | Gas | Q'ty | Visual Reference   |
|------------------|----------------|-----|------|--|
| Injector         | AU129-210-1.13 | NG  | 4    |   |
| Injector         | AU129-210-0.85 | LPG | 4    |   |
| Primary Damper   | 556F-209-7     | NG  | 1    |   |
| Primary Damper   | 556F-209-15    | LPG | 1    |   |
| Secondary Damper | 556F-208-7     | NG  | 1    |   |
| Secondary Damper | 556F-208-5     | LPG | 1    |  |
| Conversion Plate | CP-72317-1     | NG  | 1    |  |
| Conversion Plate | CP-72317-2     | LPG | 1    |  |

NOTE: LE REGULATEUR A ETRE REGULE PAR LE MANUEL D'UTILISATION. LA REGULATION EST MEORNEE VERIFIEZ LA PRESSION A LA SOURCE AVANT D'OPERER TOUT CHANGEMENT DE NIVEAU DE L'APPAREIL. AUSSI SI LA BASSE PRESSION DE CONTRÔLE PEUT ETRE OBTENUE EN FAISANT L'ETAPE 3 REGLES LA SOURCE DE PROPORION A PEU PRES AU MEME NIVEAU QUE LA PRESSION OPERENTIELLE. MAIS REPARER L'ETAPE 3 POUR LA LOCALITE DE LA VIS D'AJUSTEMENT.