

# Service Facts

## Split System Heat Pump 4A6H6024E1000A

**IMPORTANT** — This document contains a wiring diagram, a parts list, and service information. This is customer property and is to remain with this unit. Please return to service information pack upon completion of work.

**⚠ WARNING: HAZARDOUS VOLTAGE - DISCONNECT POWER and DISCHARGE CAPACITORS BEFORE SERVICING**

**⚠ CAUTION**  
**UNIT CONTAINS R-410A REFRIGERANT!**  
R-410A OPERATING PRESSURE EXCEEDS THE LIMIT OF R-22. PROPER SERVICE EQUIPMENT IS REQUIRED. FAILURE TO USE PROPER SERVICE TOOLS MAY RESULT IN EQUIPMENT DAMAGE OR PERSONAL INJURY.  
**SERVICE**  
USE ONLY R-410A REFRIGERANT AND APPROVED POE COMPRESSOR OIL.

### PRODUCT SPECIFICATIONS

OUTDOOR UNIT ①②	4A6H6024E1000A
<b>POWER CONNS.</b> — V/PH/HZ ③	230/1/60
MIN. BRCH. CIR. AMPACITY	14
BR. CIR. PROT. RTG. — MAX. (AMPS)	20
<b>COMPRESSOR</b>	DURATION™ - SCROLL
NO. USED - NO. STAGES	1 - 2
VOLTS/PH/HZ	230/1/60
R.L. AMPS ⑦ - L.R. AMPS	10.3 - 52
FACTORY INSTALLED	
START COMPONENTS ⑧	YES
INSULATION/SOUND BLANKET	NO
COMPRESSOR HEAT	YES
<b>OUTDOOR FAN</b>	PROPELLER
DIA. (IN.) - NO. USED	27.6 - 1
TYPE DRIVE - NO. SPEEDS	DIRECT - 1
CFM @ 0.0 IN. W.G. ④	3200
NO. MOTORS - HP	1 - 1/8
MOTOR SPEED R.P.M.	835
VOLTS/PH/HZ	200/230/1/60
F.L. AMPS	0.74
<b>OUTDOOR COIL</b> — TYPE	SPINE FIN™
ROWS - F.P.I.	1 - 24
FACE AREA (SQ. FT.)	27.86
TUBE SIZE (IN.)	3/8
REFRIGERANT CONTROL	EEV
<b>REFRIGERANT</b>	R-410A
LBS. — R-410A (O.D. UNIT) ⑤	10 LBS. - 3 OZ.
FACTORY SUPPLIED	YES
LINE SIZE - IN. O.D. GAS ⑥	5/8
LINE SIZE - IN. O.D. LIQ. ⑥	3/8
<b>CHARGING SPECIFICATION</b>	
SUBCOOLING	10°F
<b>DIMENSIONS</b>	H X W X D
CRATED (IN.)	46.4 X 35.1 X 38.7
<b>WEIGHT</b>	
SHIPPING (LBS.)	272
NET (LBS.)	236

### TUBING INFORMATION

Tubing Sizes		Tubing Length	Additional Refrigerant
Suction	Liquid		
5/8"	3/8"	20'	3 oz.
5/8"	3/8"	30'	8 oz.
5/8"	3/8"	40'	14 oz.
5/8"	3/8"	50'	20 oz.
5/8"	3/8"	60'	25 oz.

Tubing lengths in excess of sixty (60) feet see application software.

- ① Certified in accordance with the Air-Source Unitary Air-conditioner Equipment certification program, which is based on AHRI standard 210/240. In order to achieve AHRI standard rating, the indoor fan time delay on the comfort control must be enabled.
- ② Rated in accordance with AHRI standard 270.
- ③ Calculated in accordance with Natl. Elec. Codes. Use only HACR circuit breakers or fuses.
- ④ Standard Air — Dry Coil — Outdoor
- ⑤ This value approximate. For more precise value see unit nameplate.
- ⑥ Max. linear length 60 ft.; Max. lift - Suction 25 ft.; Max. lift - Liquid 25 ft. For greater length consult refrigerant piping software Pub. No. 32-3312-0\* (\* denotes latest revision).
- ⑦ This value shown for compressor RLA on the unit nameplate and on this specification sheet is used to compute minimum branch circuit ampacity and max. fuse size. The value shown is the branch circuit selection current.
- ⑧ No means no start components. Yes means quick start kit components. PTC means positive temperature coefficient starter.

**⚠ CAUTION**  
**HOT SURFACE!**  
**DO NOT TOUCH TOP OF COMPRESSOR.**  
May cause minor to severe burning.

**⚠ CAUTION**  
**CONTAINS REFRIGERANT!**  
**SYSTEM CONTAINS OIL AND REFRIGERANT UNDER HIGH PRESSURE. RECOVER REFRIGERANT TO RELIEVE PRESSURE BEFORE OPENING SYSTEM.**  
Failure to follow proper procedures can result in personal illness or injury or severe equipment damage.

### ⚠ WARNING

THIS INFORMATION IS INTENDED FOR USE BY INDIVIDUALS POSSESSING ADEQUATE BACKGROUNDS OF ELECTRICAL AND MECHANICAL EXPERIENCE. ANY ATTEMPT TO REPAIR A CENTRAL AIR CONDITIONING PRODUCT MAY RESULT IN PERSONAL INJURY AND OR PROPERTY DAMAGE. THE MANUFACTURER OR SELLER CANNOT BE RESPONSIBLE FOR THE INTERPRETATION OF THIS INFORMATION, NOR CAN IT ASSUME ANY LIABILITY IN CONNECTION WITH ITS USE.

### ⚠ CAUTION

RECONNECT ALL GROUNDING DEVICES.  
ALL PARTS OF THIS PRODUCT CAPABLE OF CONDUCTING ELECTRICAL CURRENT ARE GROUNDED. IF GROUNDING WIRES, SCREWS, STRAPS, CLIPS, NUTS OR WASHERS USED TO COMPLETE A PATH TO GROUND ARE REMOVED FOR SERVICE, THEY MUST BE RETURNED TO THEIR ORIGINAL POSITION AND PROPERLY FASTENED.

**NOTICE:** The manufacturer has a policy of continuous product and product data improvement and reserves the right to change design and specifications without notice.

# SCHEMATIC DIAGRAM

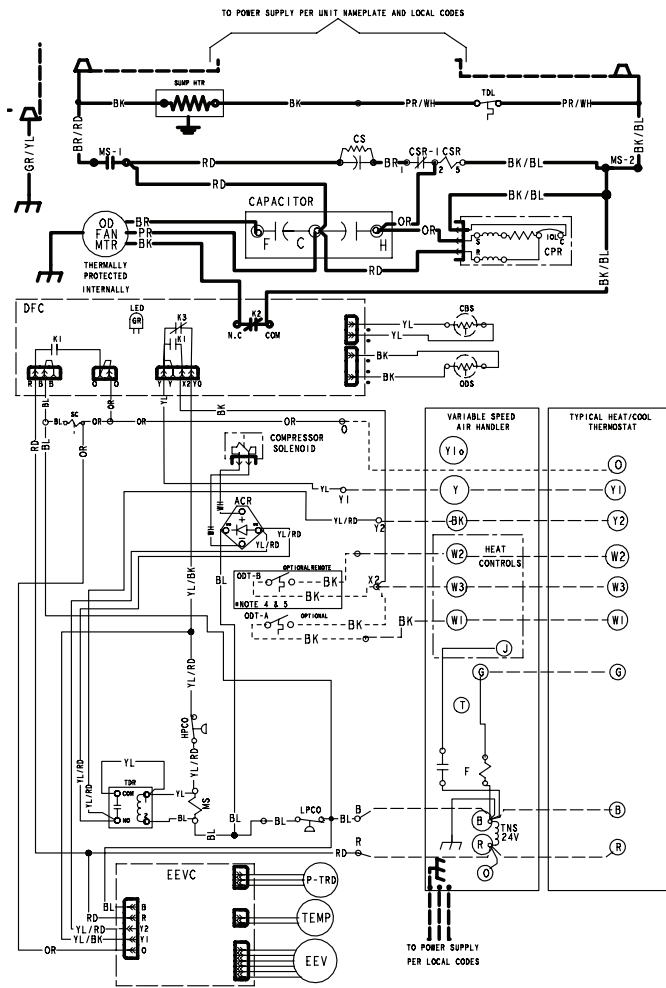

- ACR A/C RECTIFIER
- CBS COIL BOTTOM SENSOR
- CF FAN CAPACITOR
- CR BULK CONNECTOR
- CPR COMPRESSOR
- CR RUN CAPACITOR
- CS STARTING CAPACITOR
- CSR CAPACITOR SWITCHING RELAY
- DFC DEFROST CONTROL
- EEX ELECTRONIC EXP VALVE
- EEXV ELECTRONIC EXP VALVE CONTROL
- F INDOOR FAN RELAY
- HPCO HIGH PRESSURE CUTOFF SWITCH
- IDL INTERNAL OVERLOAD PROTECTOR
- LPCC LOW PRESSURE CUTOFF SWITCH
- MS COMPRESSOR MOTOR CONTACTOR
- ODL OUTDOOR ANTICIPATOR
- OFI OUTDOOR FAN THERMOSTAT
- ODS OUTDOOR TEMPERATURE SENSOR
- OOT OUTDOOR THERMOSTAT
- P-TRD PRESSURE TRANSDUCER
- SC SWITCH OVER VALVE SOLENOID
- SOH SYSTEM ON-OFF SWITCH
- TDL DISCHARGE LINE THERMOSTAT
- TRM TIME DELAY RELAY (90 SEC DELAY ON)
- TRF TRANSFORMER
- TEMP SENSOR, TEMPERATURE

**WARNING**

HAZARDOUS VOLTAGE!  
DISCONNECT ALL ELECTRICAL POWER BEFORE ANY REPAIR OR MAINTENANCE. Failure to disconnect power before working can cause severe personal injury or death.

**CAUTION**

USE COPPER CONDUCTORS ONLY! UNIT TERMINALS ARE NOT DESIGNED TO ACCEPT OTHER TYPES OF CONDUCTORS. Failure to do so may cause damage to the equipment.

- NOTES:
1. BE SURE POWER SUPPLY AGREES WITH EQUIPMENT NAMEPLATE.
  2. POWER WIRING AND GROUNDING OF EQUIPMENT MUST COMPLY WITH LOCAL CODES.
  3. LOW VOLTAGE WIRING TO BE NO. 18 AWG MINIMUM CONDUCTOR.
  4. OOT-B MUST BE SET LOWER THAN OOT-A
  5. IF OOT-B IS NOT USED, CONNECT A JUMPER WIRE FROM W3 TO W2. IF OOT-A IS NOT USED, CONNECT A JUMPER WIRE FROM W2 TO W1.
  6. IF ELECTRIC HEATER DOES NOT HAVE A 3RD CONTACTOR (CH), CONNECT A JUMPER WIRE FROM W3 TO W2. IF ELECTRIC HEATER DOES NOT HAVE A 2ND CONTACTOR (2H), CONNECT A JUMPER WIRE FROM W2 TO W1.
  7. W2 MUST BE CONNECTED TO VARIABLE SPEED AIR HANDLER TERMINAL W3 AS SHOWN, FOR PROPER INDOOR AIR FLOW DURING THE DEFROST CYCLE
  8. BE SURE THE JUMPER BETWEEN R AND BK IS CUT OR REMOVED.
  9. WITH O AND Y1/2 ENERGIZED, INDOOR FAN IS AT 100% AIRFLOW.
  10. WITH O, Y1/2 AND BK ENERGIZED, INDOOR FAN IS AT 100% AIRFLOW.

FOR CANADIAN INSTALLATIONS  
POUR INSTALLATIONS CANADIENNES

**CAUTION: NOT SUITABLE FOR USE ON SYSTEMS EXCEEDING 150V TO-GROUND ATTENTION: NE CONVIENT PAS AUX INSTALLATIONS DE PLUS DE 150 V A LA TERRE**

## SUBCOOLING CHARGING BELOW 55°F OD AMBIENT – IN HEATING ONLY

1. The Subcool Charging Method in cooling is not recommended below 55°F outdoor ambient.
2. The only recommended method of charging at outdoor ambients below 55°F, is to weigh in the charge in the heating mode.
3. Use Nameplate charge plus standard charge adders for line length.
4. Check liquid line temperature and pressure (at OD valves) to obtain a minimum of 10°F subcooling in high stage.
5. Add charge if a minimum of 10°F subcooling is not obtained with the nameplate charge plus line length correction.
6. It is important to return in the spring or summer to accurately charge the system in the cooling mode at outdoor ambients above 55°F.

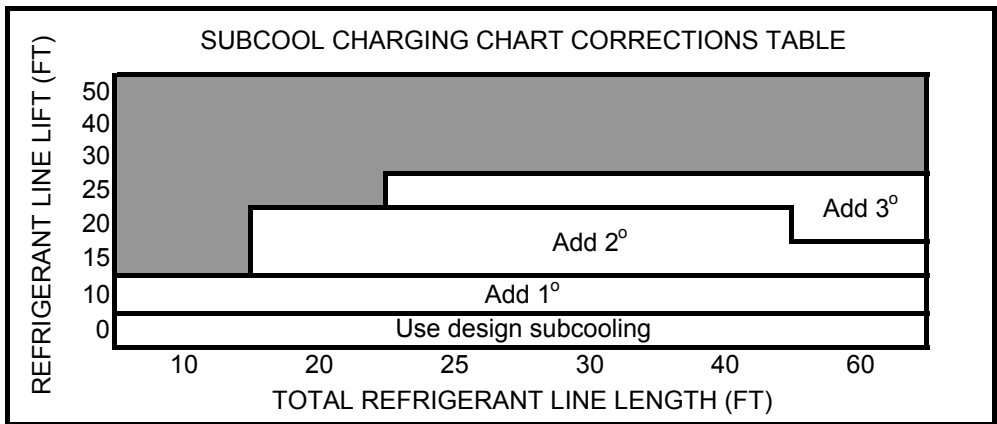

# WIRING DIAGRAM

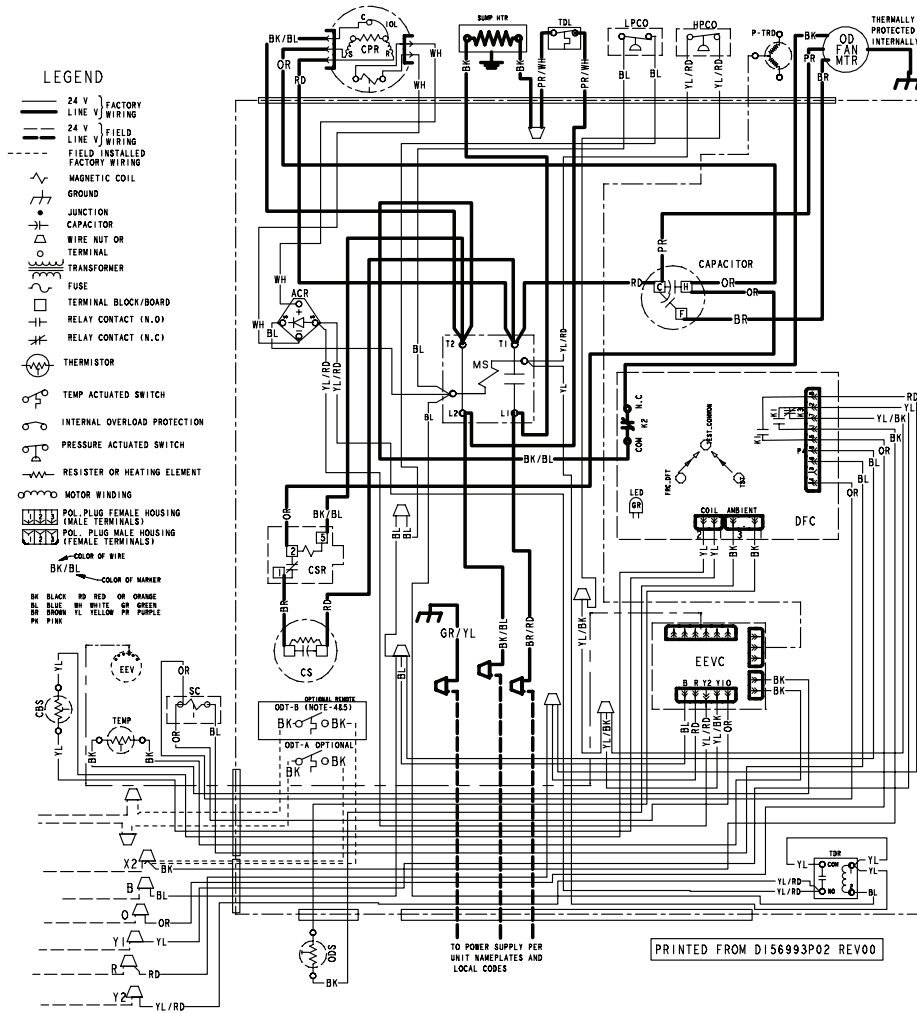

## MANUAL CHARGING (HIGH STAGE ONLY) IN COOLING BETWEEN 55°F AND 120°F OD AMBIENT

The manufacturer recommends installing approved matched indoor and outdoor systems.

All split systems are AHRI rated with only TXV indoor systems.

The benefits of installing approved indoor and outdoor split systems are maximum efficiency, optimum performance and the best overall system reliability.

The following charging methods are therefore prescribed for systems with indoor TXVs.

1. Subcooling (in the cooling mode) is the only recommended method of charging above 55°F ambient temperatures.
2. For best results - the indoor temperature should be kept between 70°F to 80°F. Add system heat if needed.
3. At start-up, or whenever charge is removed or added, the system must be operated for a minimum twenty (20) minutes to stabilize before accurate measurements can be made.
4. Measure Liquid Line Temperature and Refrigerant Pressure at service valves.
5. Determine total refrigerant line length, and height (lift) if indoor section is above the condenser. Use the **Subcool Charging Chart Corrections Table** to calculate any additional subcooling required for your specific application.
6. Determine the Design Subcooling from the unit nameplate or Service Facts. Add any additional amount of subcooling calculated in Step 5 to the Design Subcooling to arrive at the final subcooling value.
7. Locate this value in the appropriate column of the **R-410-A Refrigerant Charging Chart**. Locate your liquid line temperature in the left column of the chart, and the intersecting liquid line pressure under your calculated subcooling value column. Add refrigerant to raise the pressure to match the chart, or remove refrigerant to lower the pressure. Again, wait twenty (20) minutes for the system conditions to stabilize before adjusting charge again.
8. When system is correctly charged, you can refer to System Pressure Curves (in Service Facts) to verify typical performance.

R-410A REFRIGERANT CHARGING CHART							
LIQUID TEMP (°F)	DESIGN SUBCOOLING (°F)						
	8	9	10	11	12	13	14
LIQUID GAGE PRESSURE (PSI)							
55	179	182	185	188	191	195	198
60	195	198	201	204	208	211	215
65	211	215	218	222	225	229	232
70	229	232	236	240	243	247	251
75	247	251	255	259	263	267	271
80	267	271	275	279	283	287	291
85	287	291	296	300	304	309	313
90	309	313	318	322	327	331	336
95	331	336	341	346	351	355	360
100	355	360	365	370	376	381	386
105	381	386	391	396	402	407	413
110	407	413	418	424	429	435	441
115	435	441	446	452	458	464	470
120	464	470	476	482	488	495	501
125	495	501	507	514	520	527	533
Refer to Service Facts or Installer's Guide for charging method.							

From Dwg. D154557P01 Rev. 3

# DEFROST CONTROL

The demand defrost control measures heat pump outdoor ambient temperature with a sensor located outside the outdoor coil. A second sensor located on the outdoor coil is used to measure the coil temperature. The difference between the ambient and the colder coil temperature is the difference or delta-T measurement. This delta-T measurement is representative of the operating state and relative capacity of the heat pump system. By measuring the change in delta-T, we can determine the need for defrost. The coil sensor also serves to sense outdoor coil temperature for termination of the defrost cycle.

## Termination Temperature

Defrost controls have a selectable termination temperature. As shipped, defrost will terminate at 47°F. For a higher termination temperature, cut Jumper J2 to achieve 70°F when at or below 30°F ambient.

## Fault Identification

A fault condition is indicated by the flashing light on the defrost control inside the heat pump control box.

In normal operation, the defrost control light will flash once each second. If the light is flashing more than once per second or not at all, refer to the Defrost Checkout sheet found with the service information in the control box.

## Pin Identification

1. TEST\_COMMON (Shorting any of the other pins to this pin causes the function of the other pin to be executed. Leaving this pin open results in the normal mode of operation.)
2. TST = Test (Shorting TEST\_COMMON to this pin speeds up all defrost board timings.)
3. FRC\_DFT = Forced Defrost (Short TEST\_COMMON to this pin for two [2] seconds to initiate a forced defrost. Remove the short after defrost initiates.)

## Defrost Control Checkout

Normal operation requires:

- a. LED on board flashing 1 time/second.
- b. 24V AC between R & B.
- c. 24V AC between Y & B with unit operating.
- d. Defrost initiation when FRC\_DFT pin is shorted to TEST\_COMMON pin.

If a defrost control problem is suspected, refer to the service information in control box.

# DEFROST TERMINATION TEMPERATURE

Defrost Termination Temperatures		
	Outdoor Temperature	Termination Temperature
As Shipped	>22°F	47°F
	10°F–22°F	ODT + 25°F
	6°F–10°F	35°F
Cut Jumper 2	>30°F	47°F
	6°F–30°F	70°F
All	< 6°F	12 min. or 35°F every 3 hrs.

Defrost controls have a selectable termination temperature. Cutting jumper J2 (shown below) will achieve a termination temperature of 70° when the ambient temperature is below 30° (see table at left).

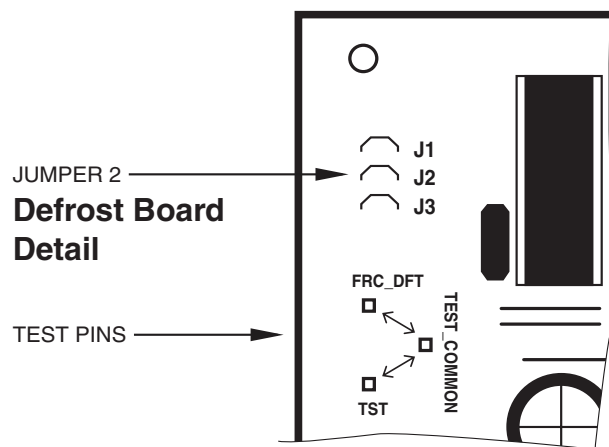

# REFRIGERATION CIRCUITS

## Heating Refrigeration Cycle

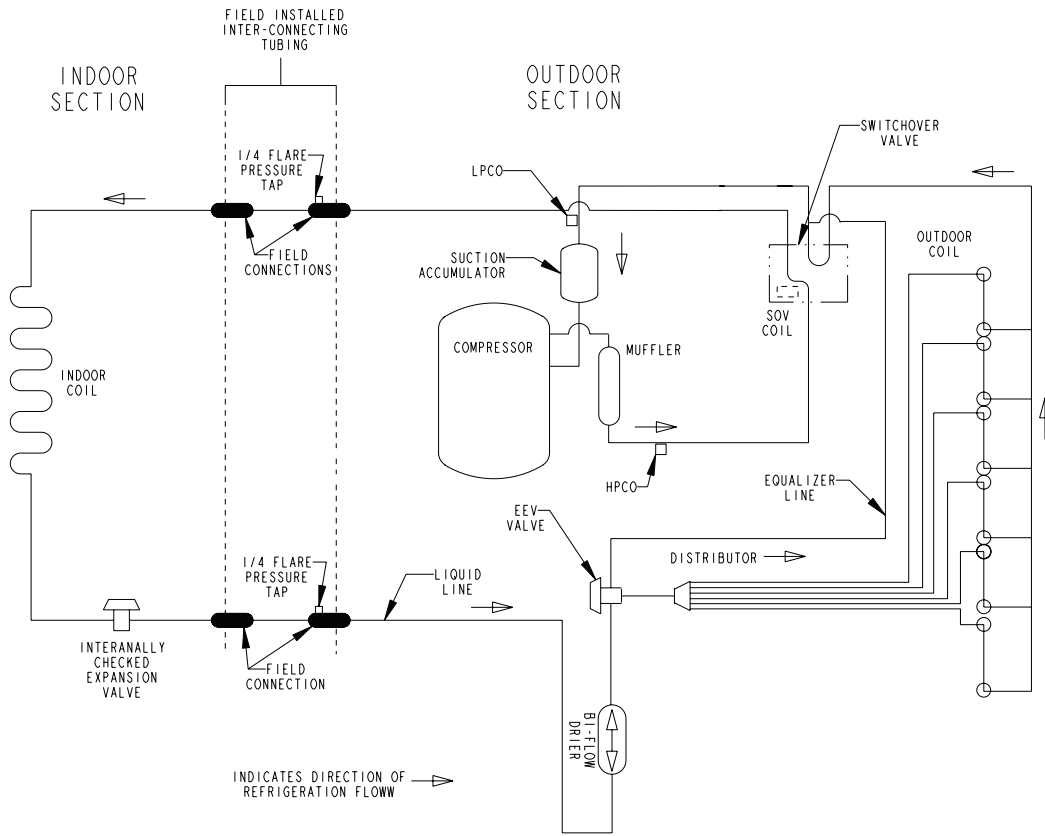

## Cooling Refrigeration Cycle

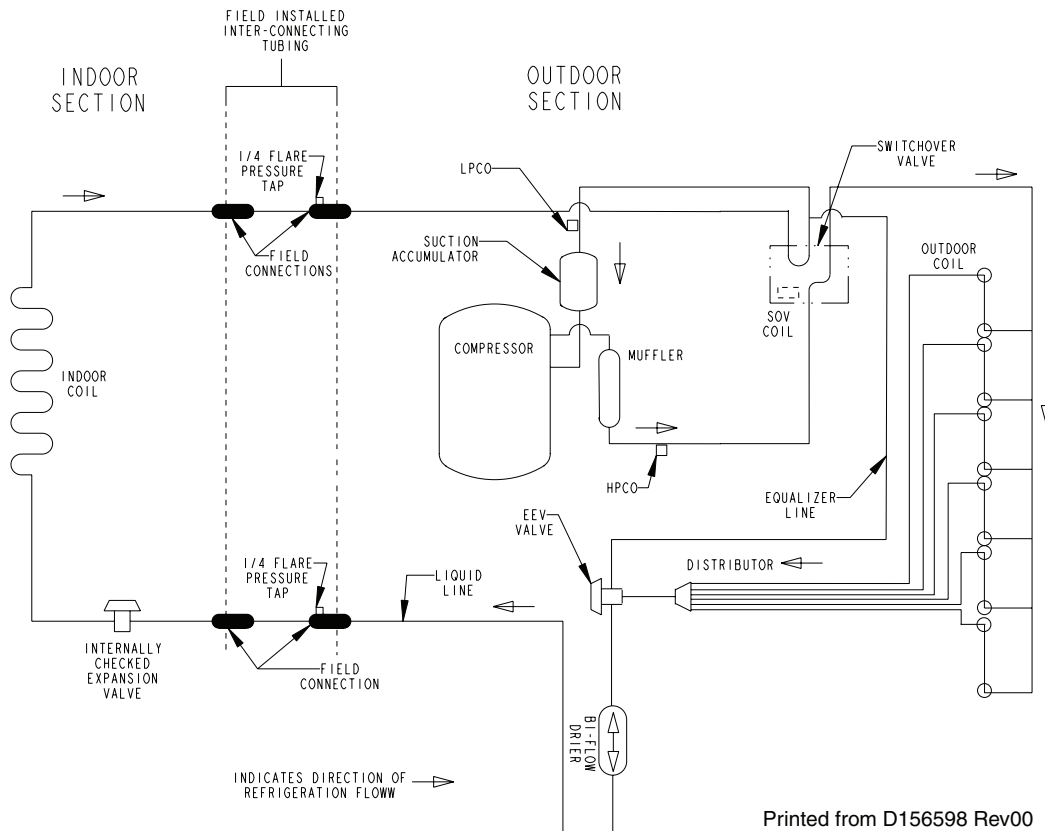

Printed from D156598 Rev00

# TROUBLESHOOTING

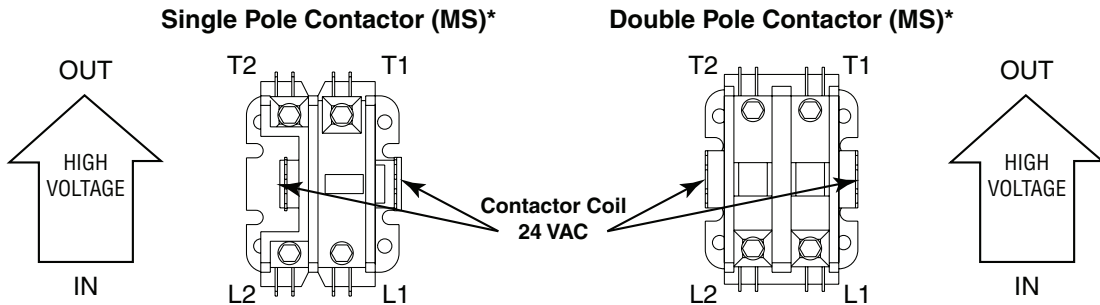
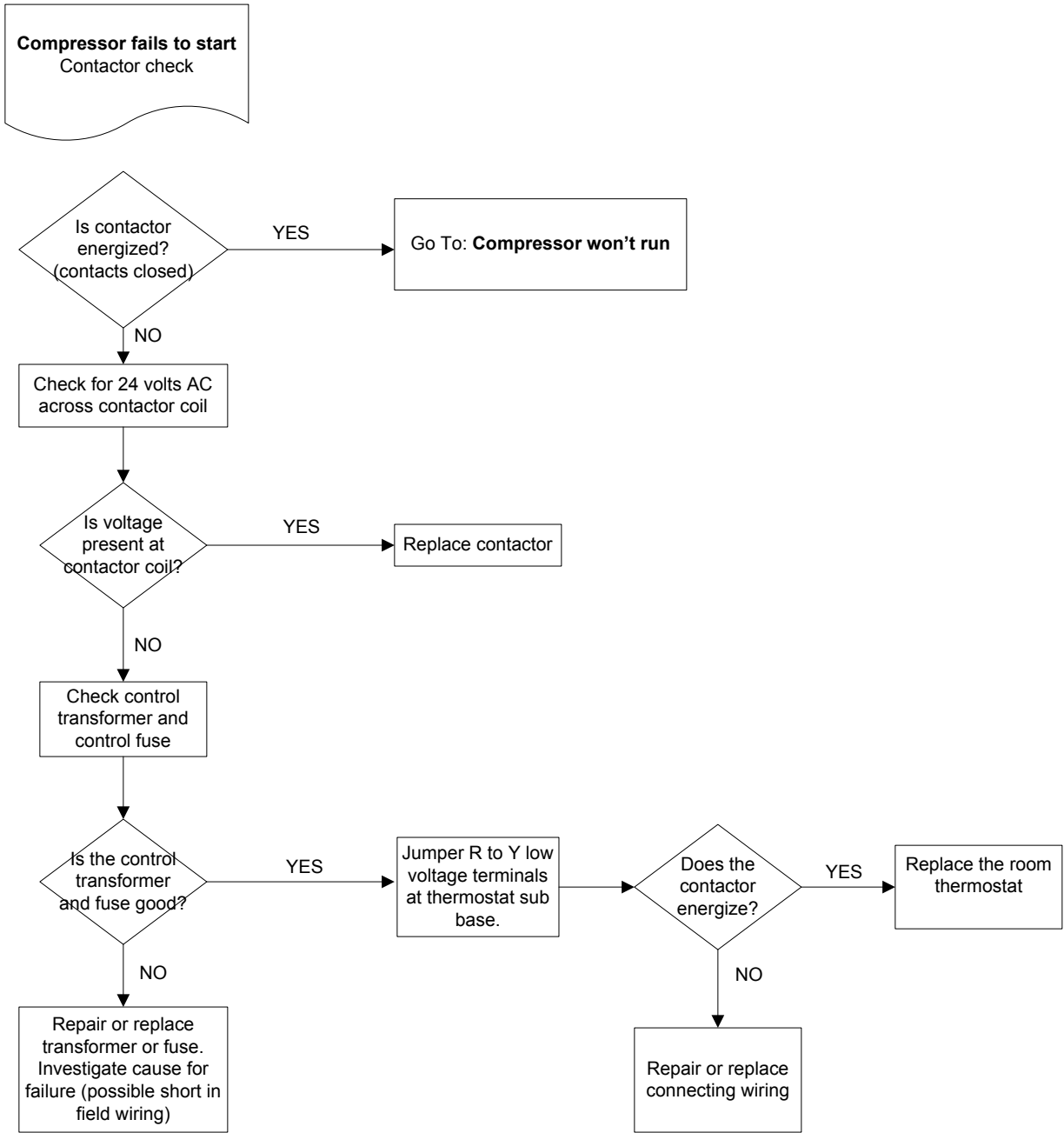

\*Refer to Wiring Diagram to determine if a single pole or double pole contactor is used.

# TROUBLESHOOTING

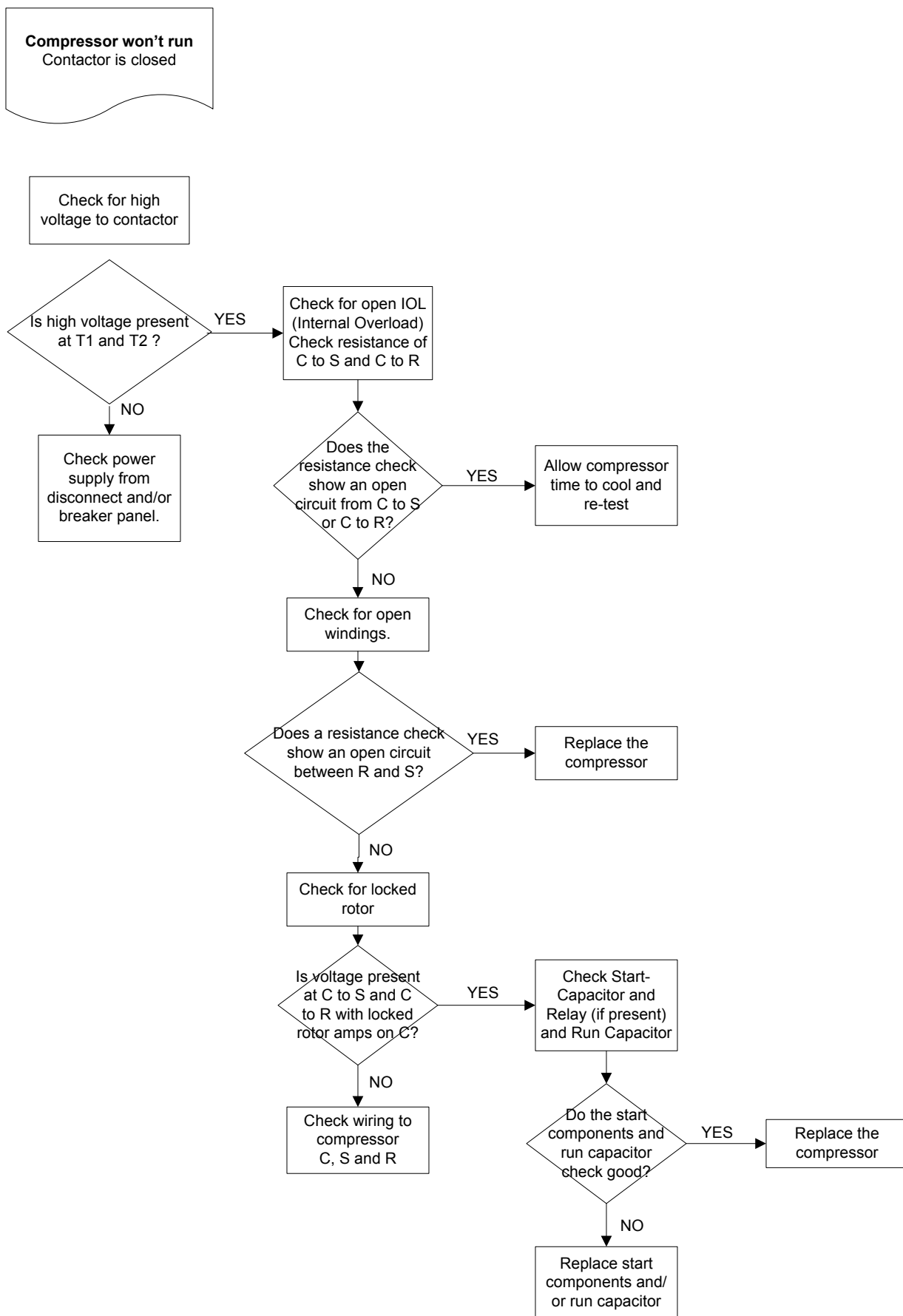

## EEV CONTROL BOARD TEST POINTS

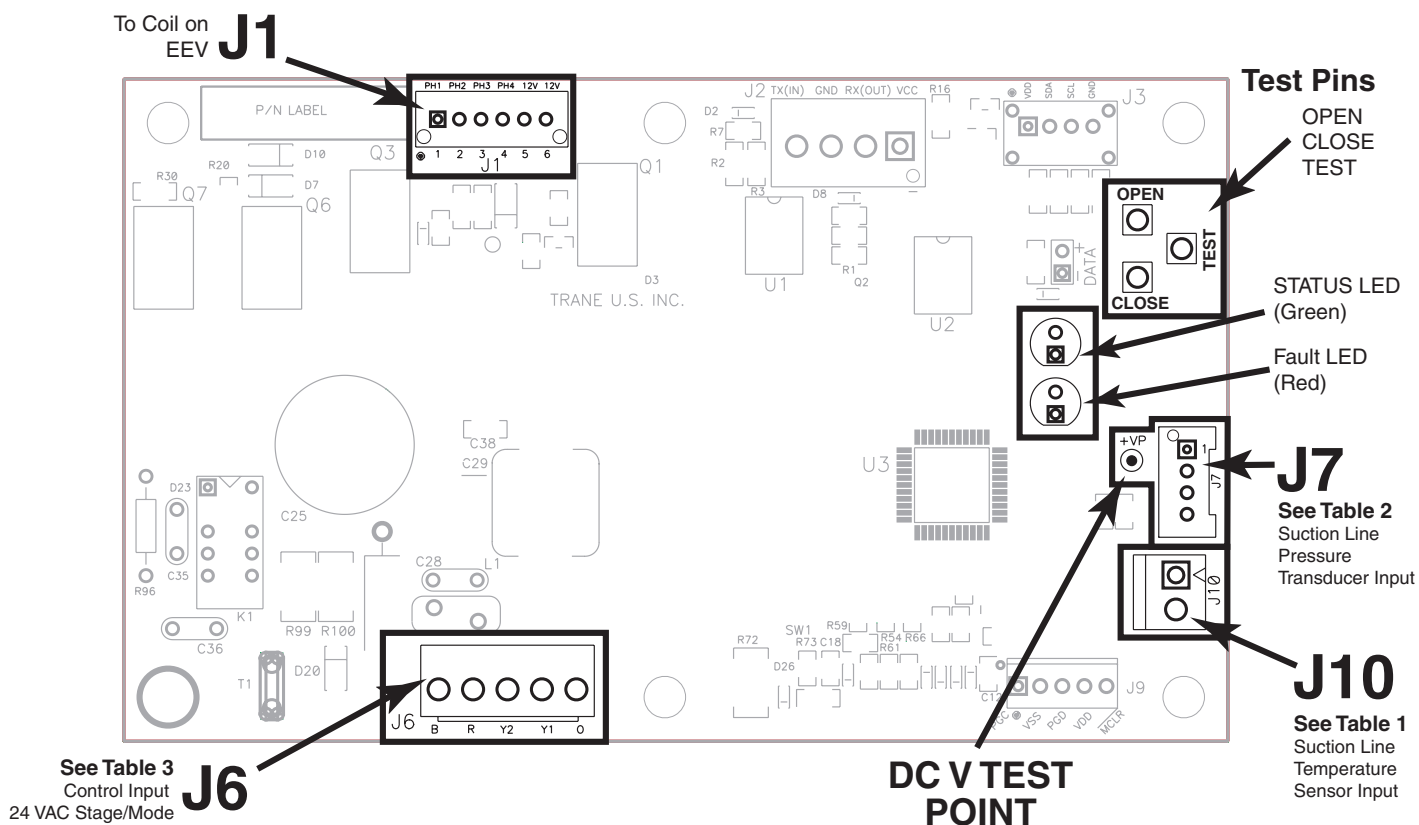

**Note:** *Close Valve and Open Valve Tests are active in any mode of operation*

Test Pins: OPEN, CLOSE, TEST (See EEV Board drawing for locations)

**Close Valve Test** - Touch CLOSE pin to TEST pin.

EEV drives closed (5 seconds max) and stays closed for 1.5 minutes (90 seconds).

- 1) Status LED will be flashing.
- 2) Gauges should indicate suction pressure dropping.
  - Valve is working.
  - LPCO may trip.

**Note:** The *Close Valve Test* will exit after 1.5 minutes (90 seconds) and will not reinitiate (requires a break and make to initialize). To clear faults stored in memory, apply a jumper between Close and Test pins for 10 seconds.

**Open Valve Test** - Touch OPEN pin to TEST pin.

EEV drives open (5 sec max) and stays open for 30 seconds.

- 1) Status LED will be flashing.
- 2) Temperature probe should indicate superheat falling.
  - Valve is working.

**Note:** If jumper is left on pins, the OPEN VALVE TEST will be cleared after 30 seconds and will not reinitiate (requires a break and make to reinitialize).

**Exit Test Mode** - The Open Valve Test or Closed Valve Test can be cancelled by jumping to the opposite mode Test pin. The system will return to normal super heat control.

Test mode will cancel if:

- 1) Unit enters Defrost
- 2) Y1 input is lost



**TABLE 1**

**Suction Line Temperature Sensor - J10**

<i>Temp °F</i>	<i>Temp °C</i>	<i>THERMISTOR RESISTANCE (OHMS)</i>	<i>Volts DC at Plug J10 (pin to pin)</i>
0	-17.8	83247	3.87
5	-15.0	71108	3.73
10	-12.2	60916	3.57
15	-9.4	52333	3.41
20	-6.7	45076	3.25
25	-3.9	38927	3.08
30	-1.1	33703	2.91
35	1.7	29253	2.73
40	4.4	25452	2.56
45	7.2	22198	2.39
50	10.0	19405	2.22
55	12.8	17002	2.06
60	15.6	14930	1.90
65	18.3	13138	1.75
70	21.1	11586	1.61
75	23.9	10238	1.48
80	26.7	9065	1.36
85	29.4	8043	1.24
90	32.2	7150	1.14
95	35.0	6368	1.04
100	37.8	5682	0.95
105	40.6	5079	0.86
110	43.3	4548	0.79
115	46.1	4079	0.72
120	48.9	3665	0.66
125	51.7	3298	0.60
130	54.4	2972	0.54
135	57.2	2683	0.50
136	57.8	2629	0.49
137	58.3	2576	0.48
138	58.9	2525	0.47
139	59.4	2474	0.46
140	60.0	2425	0.45
141	60.6	2377	0.45
142	61.1	2330	0.44
143	61.7	2284	0.43
144	62.2	2239	0.42
145	62.8	2195	0.41
146	63.3	2153	0.41
147	63.9	2111	0.40
148	64.4	2070	0.39
149	65.0	2030	0.39
150	65.6	1990	0.38

**TABLE 2**

**Suction Line Pressure Transducer - J7**

Voltage to pressure reference Chart

<i>Pressure (PSIG)</i>	<i>Volts DC at plug J7 (to test point common)</i>
34	0.8
41	0.9
51	1.0
60	1.1
70	1.2
80	1.3
89	1.4
99	1.5
108	1.6
118	1.7
130	1.8
140	1.9
147	2.0
159	2.1
169	2.2
178	2.3
188	2.4
198	2.5

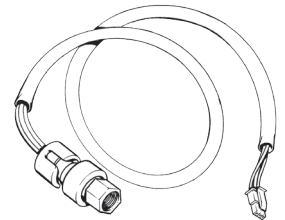

Suction Line Pressure Transducer

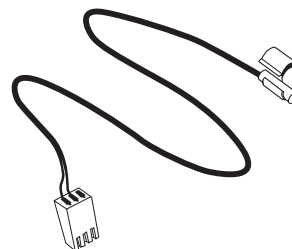

Suction Line Temperature Sensor

# ELECTRONIC EXPANSION VALVE (EEV) CONTROL BOARD

## Status LED (Green)

On - Control has power

Flashing Fast - Control is driving valve (5 seconds max drive time)

Flashing Pattern - See Table 6.

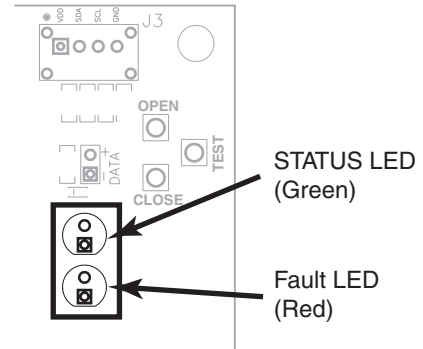

**TABLE 3**  
**Control Input and Status LED - J6**

EEV control		STATUS LED								24 VAC at plug J6	
Heat	Standby	ON Continuous								B to R	
	1st Stage	ON	OFF				ON	OFF			B to R & Y1
	2nd Stage	ON	OFF	ON	OFF			ON	ON	OFF	B to R, Y1 & Y2
Cool	Standby	OFF	ON				OFF	ON			B to R & O
	1st Stage	ON	OFF								B to R, Y1 & O
	2nd Stage	ON	OFF	ON	OFF					B to R, Y1, Y2 & O	
		1 sec		2 sec		3 sec		4 sec			

## Fault LED (Red)

LED Color	EEV Fault LED	Description
Red	OFF	Standby
	1 Flash	Coil has an open circuit or intermittent short (Replace Coil)
	2 Flash	Control has detected an internal failure (Replace EEV control board)
	3 Flash	Suction Pressure Transducer input is out of range (Replace transducer) (1)
	4 Flash	Suction Temperature Sensor input is out of range (Replace sensor) (1)
	5 Flash	Coil has short circuit (Replace Coil) (2)
	<b>The following may require additional diagnostics</b>	
	6 Flash	Valve is not responding to a position change command (Possible stuck valve)
	7 Flash	Valve is responding but system is not performing properly (Low charge or restriction)
	8 Flash	Compressor is not pumping (3)
9 Flash	Low superheat in Cooling Mode (Indoor TXV stuck open or ID Fan failure)	
10 Flash	Not used at this time	
<b>EEV Fault Codes</b>		
<b>Notes:</b>	EEV not used on all models (1) Valve will close and LPCO will trip (2) Power supply will shut down to protect board (3) Monitor superheat and pressure: <3' SH for 5 minutes with valve @ minimum position, Monitor off-cycle pressure and compare to next on-cycle for pressure drop within 60 seconds	

Printed from D802247P01 Rev08

### Fault Storing/CleAHRing:

Faults 6-9 will be stored in non-volatile memory. See Close Valve Test for fault cleAHRing procedure. Faults 1-5 will clear with a power cycle.

## TROUBLESHOOTING THE EEV

The **Electronic Expansion Valve (EEV)** installed in this heat pump is designed to control superheat entering the compressor when the system is running in mechanical heating mode. During cooling mode, refrigerant flow bypasses the EEV via a check valve and is controlled by the expansion device in the indoor unit. Therefore, **any operational problems observed in cooling mode are not caused by the EEV.**

The following flow chart was designed to assist in troubleshooting the EEV.

Note: The EEV closes with every OFF cycle in the heating mode of operation. During Defrost and in the cooling mode of operation, the EEV will drive to 1/2 open. An audible sound can be heard when valve is changing positions.

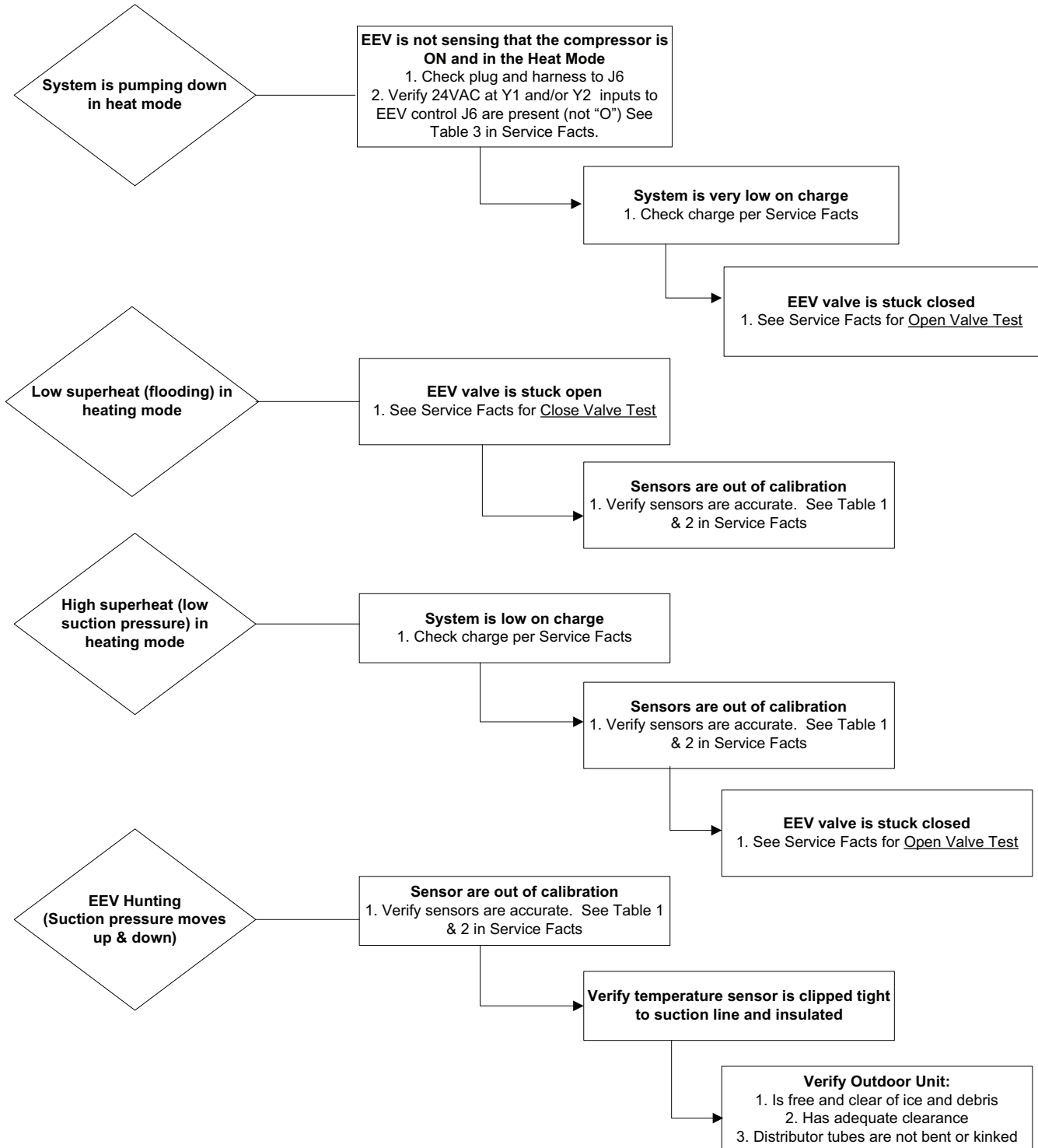

**PRESSURE CURVES FOR 4A6H6024E1000A  
4TEE3F39A**

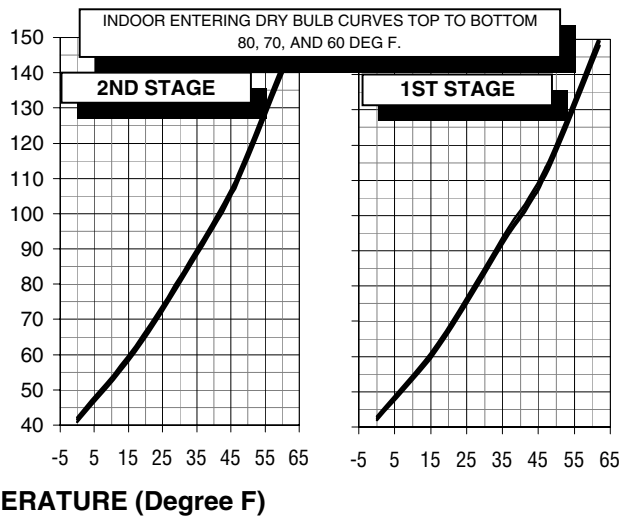
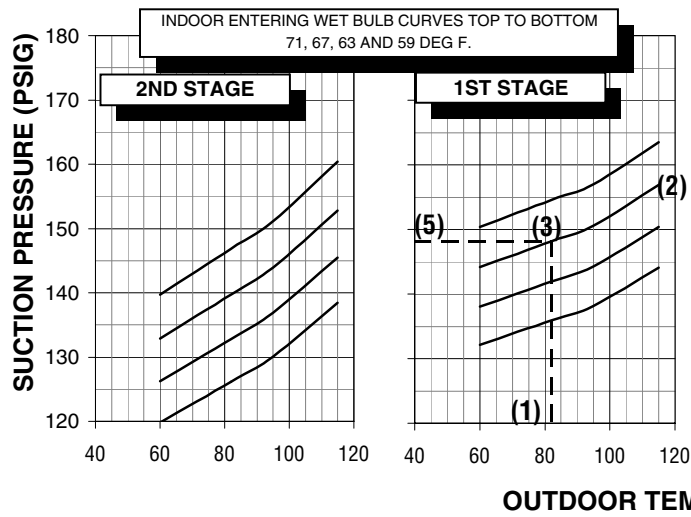
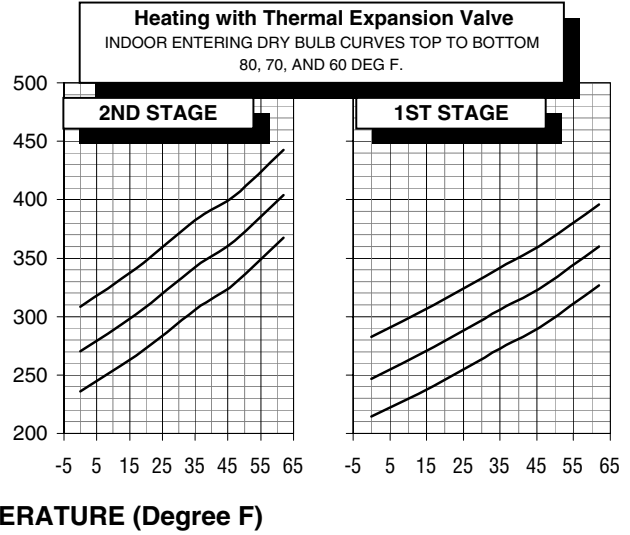
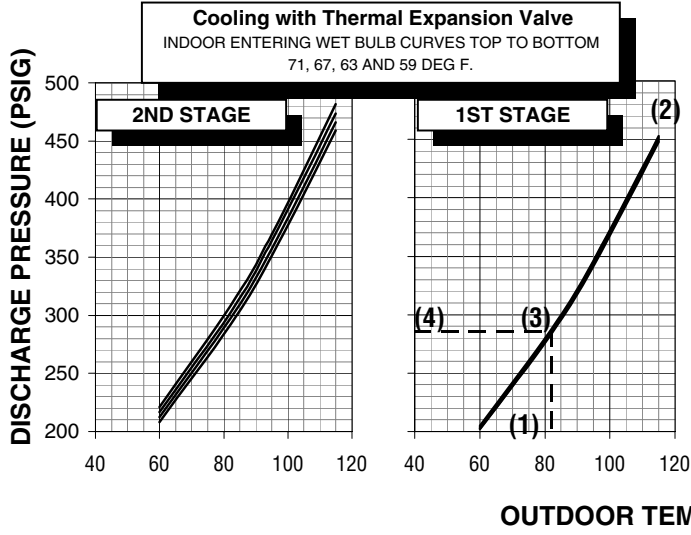

**COOLING PERFORMANCE CAN BE CHECKED WHEN THE OUTDOOR TEMP IS ABOVE 65 DEG F.**

TO CHECK COOLING PERFORMANCE, SELECT THE PROPER INDOOR CFM, ALLOW PRESSURES TO STABILIZE. MEASURE INDOOR WET BULB TEMPERATURE, OUTDOOR TEMPERATURE, DISCHARGE AND SUCTION PRESSURES. ON THE PLOTS LOCATE OUTDOOR TEMPERATURE (1); LOCATE INDOOR WET BULB (2); FIND INTERSECTION OF OD TEMP. & ID W.B. (3); READ DISCHARGE OR SUCTION PRESSURE IN LEFT COLUMN (4).

- EXAMPLE: (1) OUTDOOR TEMP. 82 F.  
 (2) INDOOR WET BULB 67 F.  
 (3) AT INTERSECTION  
 (4) DISCHARGE PRESSURE @ 700 CFM IS 286 PSIG  
 (5) SUCTION PRESSURE @ 700 CFM IS 148 PSIG

ACTUAL:  
 DISCHARGE PRESSURE SHOULD BE +/- 10 PSIG OF CHART  
 SUCTION PRESSURE SHOULD BE +/- 3 PSIG OF CHART

INTERCONNECTING LINES  
 GAS - 5/8" O.D.  
 LIQUID - 3/8" O.D.

DWG.NO. 4A6H6024E1

