

## RESIDENTIAL GAS WATER HEATERS



**GAS-FIRED**



**POWER VENT/POWER DIRECT VENT GAS MODELS  
WITH HOT SURFACE IGNITION**



**WARNING:** If the information in these instructions is not followed exactly, a fire or explosion may result causing property damage, personal injury or death.

- Do not store or use gasoline or other flammable vapors and liquids in the vicinity of this or any other appliance.
- **WHAT TO DO IF YOU SMELL GAS:**
  - Do not try to light any appliance.
  - Do not touch any electrical switch; do not use any phone in your building.
  - Immediately call your gas supplier from a neighbor's phone. Follow the gas supplier's instructions.
  - If you cannot reach your gas supplier, call the fire department.
- Installation and service must be performed by a qualified installer, service agency or the gas supplier.



### **⚠ WARNING**

Read and understand instruction manual and safety messages before installing, operating or servicing this water heater.

Failure to follow instructions and safety messages could result in death or serious injury.

Instruction manual must remain with water heater.

**• For Your Safety •**  
AN ODORANT IS ADDED TO THE GAS USED  
BY THIS WATER HEATER.

**ALL TECHNICAL AND WARRANTY QUESTIONS:** SHOULD BE DIRECTED TO THE LOCAL DEALER FROM WHOM THE WATER HEATER WAS PURCHASED. IF YOU ARE UNSUCCESSFUL, CALL THE TECHNICAL SUPPORT PHONE NUMBER SHOWN ON THE WATER HEATER LABELING.





**KEEP THIS MANUAL IN THE POCKET ON HEATER FOR FUTURE REFERENCE  
WHENEVER MAINTENANCE ADJUSTMENT OR SERVICE IS REQUIRED.**

# SAFE INSTALLATION, USE AND SERVICE

Your safety and the safety of others is extremely important in the installation, use and servicing of this water heater.

Many safety-related messages and instructions have been provided in this manual and on your own water heater to warn you and others of a potential injury hazard. Read and obey all safety messages and instructions throughout this manual. It is very important that the meaning of each safety message is understood by you and others who install, use or service this water heater.

	<p>This is the safety alert symbol. It is used to alert you to potential personal injury hazards. Obey all safety messages that follow this symbol to avoid possible injury or death.</p>
---	---

	<p><b>DANGER</b> indicates an imminently hazardous situation which, if not avoided, will result in injury or death.</p>
	<p><b>WARNING</b> indicates a potentially hazardous situation which, if not avoided, could result in injury or death.</p>
	<p><b>CAUTION</b> indicates a potentially hazardous situation which, if not avoided, could result in minor or moderate injury.</p>
	<p><b>CAUTION</b> used without the safety alert symbol indicates a potentially hazardous situation which, if not avoided, could result in property damage.</p>

All safety messages will generally tell you about the type of hazard, what can happen if you do not follow the safety message and how to avoid the risk of injury.

The California Safe Drinking Water and Toxic Enforcement Act requires the Governor of California to publish a list of substances known to the State of California to cause cancer, birth defects, or other reproductive harm, and requires businesses to warn of potential exposure to such substances.

This product contains a chemical known to the State of California to cause cancer, birth defects, or other reproductive harm. This appliance can cause low level exposure to some of the substances listed.

## IMPORTANT DEFINITIONS

- **Qualified Installer or Service Agency:** Installation and service of this water heater requires ability equivalent to that of a Qualified Agency (as defined by ANSI below) in the field involved. Installation skills such as plumbing, air supply, venting, gas supply, electrical supply are required in addition to electrical testing skills when performing service.
- **ANSI Z223.1 2006 Sec. 3.3.83:** "Qualified Agency" - "Any individual, firm, corporation or company that either in person or through a representative is engaged in and is responsible for (a) the installation, testing or replacement of gas piping or (b) the connection, installation, testing, repair or servicing of appliances and equipment; that is experienced in such work; that is familiar with all precautions required; and that has complied with all the requirements of the authority having jurisdiction."
- **Gas Supplier:** The Natural Gas or Propane Utility or service who supplies gas for utilization by the gas burning appliances within this application. The gas supplier typically has responsibility for the inspection and code approval of gas piping up to and including the Natural Gas meter or Propane storage tank of a building.



# GENERAL SAFETY

	<b>⚠ WARNING</b>
	<p>Read and understand instruction manual and safety messages before installing, operating or servicing this water heater.</p> <p>Failure to follow instructions and safety messages could result in death or serious injury.</p> <p>Instruction manual must remain with water heater.</p>

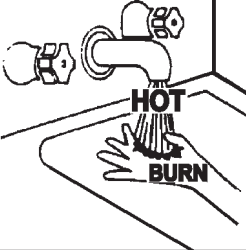
	<b>⚠ WARNING</b>
	<b>Fire Hazard</b> <p>For continued protection against risk of fire:</p> <ul style="list-style-type: none"><li>• Do not install water heater on carpeted floor.</li><li>• Do not operate water heater if flood damaged.</li></ul>

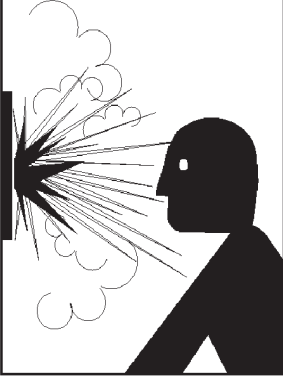
<b>⚠ DANGER</b>	<p>Water temperature over 125°F (52°C) can cause severe burns instantly resulting in severe injury or death.</p> <p>Children, the elderly, and the physically or mentally disabled are at highest risk for scald injury.</p> <p>Feel water before bathing or showering.</p> <p>Temperature limiting valves are available.</p> <p>Read instruction manual for safe temperature setting.</p>
	

	<b>⚠ WARNING</b>
	<b>Explosion Hazard</b> <ul style="list-style-type: none"><li>• Overheated water can cause water tank explosion.</li><li>• Properly sized temperature and pressure relief valve must be installed in opening provided.</li></ul>

<b>⚠ WARNING</b>	
<b>Fire or Explosion Hazard</b>	
<ul style="list-style-type: none"><li>• Do not store or use gasoline or other flammable vapors and liquids in the vicinity of this or any other appliance.</li><li>• Avoid all ignition sources if you smell LP gas.</li><li>• Do not expose water heater control to excessive gas pressure.</li><li>• Use only gas shown on rating plate.</li><li>• Maintain required clearances to combustibles.</li><li>• Keep ignition sources away from faucets after extended period of non-use.</li></ul>	
	<p>Read instruction manual before installing, using or servicing water heater.</p>
	

# GENERAL SAFETY

## CAUTION

**Improper Installation, use and service may result in property damage.**

- Do not operate water heater if flood damaged.
- Inspect anode rods regularly, replace when significantly depleted.
- Install in location with drainage.
- Fill tank with water before operation.
- Properly sized thermal expansion tanks are required on all closed water systems.

Refer to this manual for installation and service.

## ⚠ WARNING



- Before servicing the water heater, make sure the blower assembly is unplugged or the electrical supply to the water heater is turned "OFF".
- Label all wires prior to disconnection when servicing controls. Wiring error can cause improper and dangerous operation. Verify proper operation after servicing.
- Failure to do this could result in death, serious bodily injury, or property damage.

## ⚠ WARNING

**Breathing Hazard - Carbon Monoxide Gas**

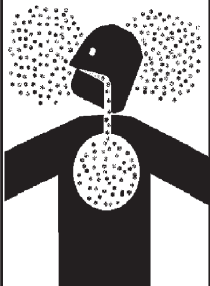

- Install vent system in accordance with codes.
- Do not operate water heater if flood damaged.
- Special Consideration must be taken with installations above 10,100' (3,078m) for standard models.
- Do not operate if soot buildup is present.
- Do not obstruct water heater air intake with insulating jacket.
- Do not place chemical vapor emitting products near water heater.
- Gas and carbon monoxide detectors are available.
- No vent damper installation is compatible with this power vented water heater.
- Form an approximately 8" diameter loop in the condensate hoses on top of the water heater to trap water and prevent the escape of combustion by-products.
- Do not elevate the condensate hose on the bottom of the water heater above the bracket attached to the side of the unit. This must be true for the entire length of the hose including the exit into an appropriate drain.
- Condensate lines must be free and clear of debris and must not allow back flow through the hose. The condensate lines must be able to flow freely to an appropriate drain.
- Do not allow condensate lines to become crimped closed.
- Analyze the entire vent system to make sure that condensate will not become trapped in a section of vent pipe and therefore reduce the open cross sectional area of the vent.

Breathing carbon monoxide can cause brain damage or death.  
Always read and understand instruction manual.

## ⚠ DANGER



**⚠ Vapors from flammable liquids may explode and catch fire causing death or severe burns.**

Do not use or store flammable products such as gasoline, solvents or adhesives in the same room or area near the water heater.

Keep flammable products:

1. far away from heater,
2. in approved containers,
3. tightly closed and
4. out of children's reach.

**Installation:**

Do not install the water heater where flammable products will be stored or used unless the main burner and hot surface igniter are

Water heater has a main burner and hot surface igniter. The hot surface igniter:

1. can come on at any time and
2. will ignite flammable vapors.

Vapors:

1. cannot be seen,
2. are heavier than air,
3. go a long way on the floor and
4. can be carried from other rooms to the hot surface igniter by air currents.

at least 18" above the floor. This will reduce, but not eliminate, the risk of vapors being ignited by the main burner or hot surface igniter.

# TABLE OF CONTENTS

SAFE INSTALLATION, USE AND SERVICE.....	2	Installation Sequence.....	21
GENERAL SAFETY.....	3	Vertical Vent Terminal Installation.....	21
TABLE OF CONTENTS.....	5	Installation of Vent System, Sidewall.....	22
INTRODUCTION.....	5	Installation of Vertical Vent System.....	22
Preparing for the Installation.....	5	Vent Pipe Preparation.....	26
Get to Know Your Water Heater.....	6	Controls and Switches.....	28
INSTALLATION CONSIDERATIONS.....	7	Power Vent Wiring Schematic.....	29
Rough In Dimensions.....	7	LIGHTING & OPERATING LABEL.....	30
Commonwealth of Massachusetts.....	8	TEMPERATURE REGULATION.....	31
Water Piping - Mixing Valve Usage.....	9	USING THE ELECTRONIC CONTROLLER.....	32
Facts to Consider About Location.....	10	FOR YOUR INFORMATION.....	36
Insulation Blankets.....	11	Start Up Conditions.....	
Combustion Air and Ventilation.....	11	Smoke/Odor.....	36
Appliances in Unconfined Spaces.....	11	Thermal Expansion.....	36
Appliances in Confined Spaces.....	11	Strange Sounds.....	36
INSTALLING THE WATER HEATER.....	13	Operational Conditions.....	36
Chemical Vapor Corrosion.....	13	Smelly Water.....	36
Water Piping.....	13	"Air" in Hot Water Faucets.....	36
Temperature-Pressure Relief Valve.....	14	PERIODIC MAINTENANCE.....	37
Gas Piping.....	15	Venting System Inspection.....	37
Sediment Traps.....	16	Burner Operation and Inspection.....	37
Filling the Water Heater.....	16	Burner Cleaning.....	37
Venting.....	16	Housekeeping.....	37
Vent Pipe Termination.....	16-17	Anode Rod Inspection.....	38
Planning the Vent System.....	19	Temperature-Pressure Relief Valve Operation.....	38
Condensate.....	19	Draining.....	38
Installation of Vent System.....	20	Service.....	39
Vent Terminal Installation, Sidewall.....	20	LEAKAGE CHECKPOINTS.....	39
Sequence of Installations, Figure 18A.....	20	TROUBLESHOOTING.....	40
Direct Venting.....	20	NOTES.....	41-42
Direct Vent Terminal Installation.....	20	WARRANTY.....	43

## INTRODUCTION

**Thank You** for purchasing this water heater. Properly installed and maintained, it should give you years of trouble free service.

Abbreviations Found In This Instruction Manual:

- CSA - Canadian Standards Association
- ANSI - American National Standards Institute
- NFPA - National Fire Protection Association
- ASME - American Society of Mechanical Engineers
- GAMA - Gas Appliance Manufacturer's Association
- UL - Underwriters Laboratories Inc.

This gas-fired water heater is design certified by Underwriters Laboratories Inc. under American National Standard/CSA Standard for Gas Water Heaters ANSI Z21.10.3 • CSA 4.3 (current edition).

### PREPARING FOR THE INSTALLATION

1. Read the "General Safety" section, page 3 and 4 of this manual first and then the entire manual carefully. If you don't follow the safety rules, the water heater will not operate properly. It could cause DEATH, SERIOUS BODILY INJURY AND/OR PROPERTY DAMAGE.

This manual contains instructions for the installation, operation, and maintenance of the gas-fired water heater. It also contains warnings throughout the manual that you must read and be aware of. All warnings and all instructions are essential to the proper operation of the water heater and your safety. Since we cannot put everything on the first few pages, **READ THE ENTIRE MANUAL BEFORE ATTEMPTING TO INSTALL OR OPERATE THE WATER HEATER.**

2. The installation must conform with these instructions and the local code authority having jurisdiction. In the absence of local codes, the installation must comply with the current editions of the National Fuel Gas Code, ANSI Z223.1/NFPA 54 and the National Electrical Code, NFPA 70 or CAN/CSA-B149.1, the Natural Gas and Propane Installation Code and CSA C22.1, the Canadian Electrical Code. All documents are available from the Canadian Standards Association, 8501 East Pleasant Valley Road, Cleveland, OH 44131. NFPA documents are also available from the National Fire Protection Association, 1 Batterymarch Park, Quincy, MA 02269.

3. The water heater when installed must be grounded in accordance with the local codes, or in the absence of local codes: the National Electrical Code (NFPA 70) or the Canadian Electrical Code (C22.1).

4. If after reading this manual you have any questions or do not understand any portion of the instructions, call the local gas utility or the manufacturer whose name appears on the rating plate.

5. Carefully plan the place where you are going to put the water heater. Correct combustion, vent action, and vent pipe installation are very important in preventing death from possible carbon monoxide poisoning and fires, see Figures 1 and 2.

Examine the location to ensure the water heater complies with the "Facts to Consider About Location" section in this manual.

6. For California installation this water heater must be braced, anchored, or strapped to avoid falling or moving during an earthquake. See instructions for correct installation procedures. Instructions may be obtained from California Office of the State Architect, 400 P Street, Sacramento, CA 95814.

7. Massachusetts Code requires this water heater to be installed in accordance with Massachusetts 248-CMR 2.00: State Plumbing Code and 248-CMR 5.00. See page 8.

8. Complies with SCAQMD rule #1146 and districts having equivalent NOx requirements.

# GET TO KNOW YOUR WATER HEATER - GAS MODELS

- |                                |                                 |                            |
|--------------------------------|---------------------------------|----------------------------|
| A Control Assembly             | M Display Enclosure             | Y Inlet Dip Tube           |
| B Blocked Inlet Switch         | **N Exhaust Elbow Assembly      | Z T/P Relief Valve         |
| C Blocked Outlet Switch        | **O Condensate Tubing           | AA Rating Plate            |
| D Fan Prover Switch            | P Off/On Switch                 | BB Labels                  |
| E Blower Assembly              | Q Display Label                 | CC Drain Valve             |
| F Burner Assembly              | R Hot Water Outlet              | **DD Vent Terminal         |
| G Flame Sensor                 | *S Electrical Outlet (120VAC)   | EE Metal Drain Pan         |
| H Hot Surface Igniter          | T Gas Supply                    | FF Anode                   |
| I Junction Box                 | U Main Manual Gas Shutoff Valve | GG Insulation              |
| J Gas Control Valve Thermostat | V Union                         | HH Upper Temperature Probe |
| K Display Board                | W Inlet Water Shutoff Valve     | II Access Door             |
| L Top Plastic Enclosure        | X Cold Water Inlet              |                            |

## REPLACEMENT PARTS AND DELIMING PRODUCTS

Replacement parts and recommended delimer may be ordered through authorized servicers or distributors. When ordering parts, provide complete model and serial numbers (see rating plate), quantity and name of part desired. Standard hardware items may be purchased locally.

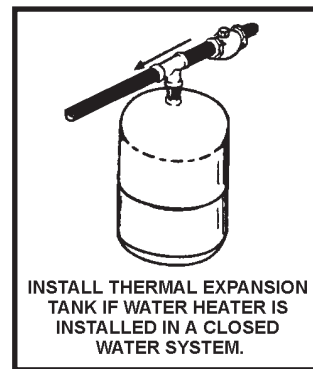
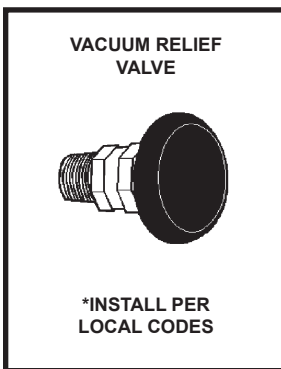
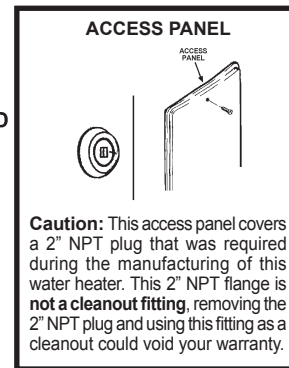
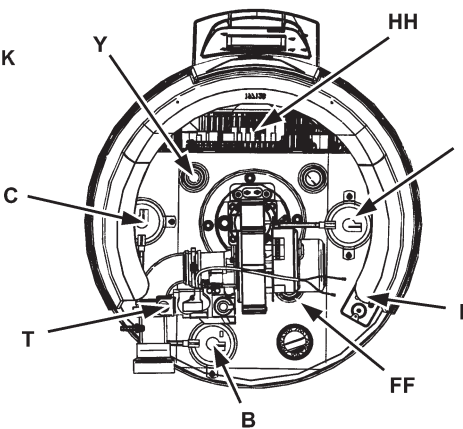
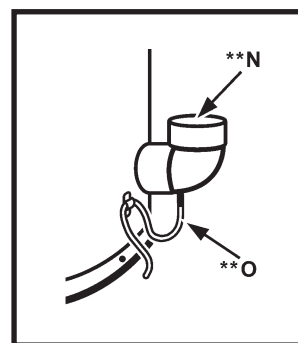
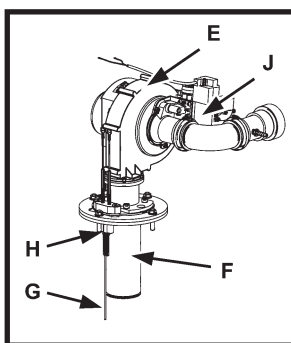
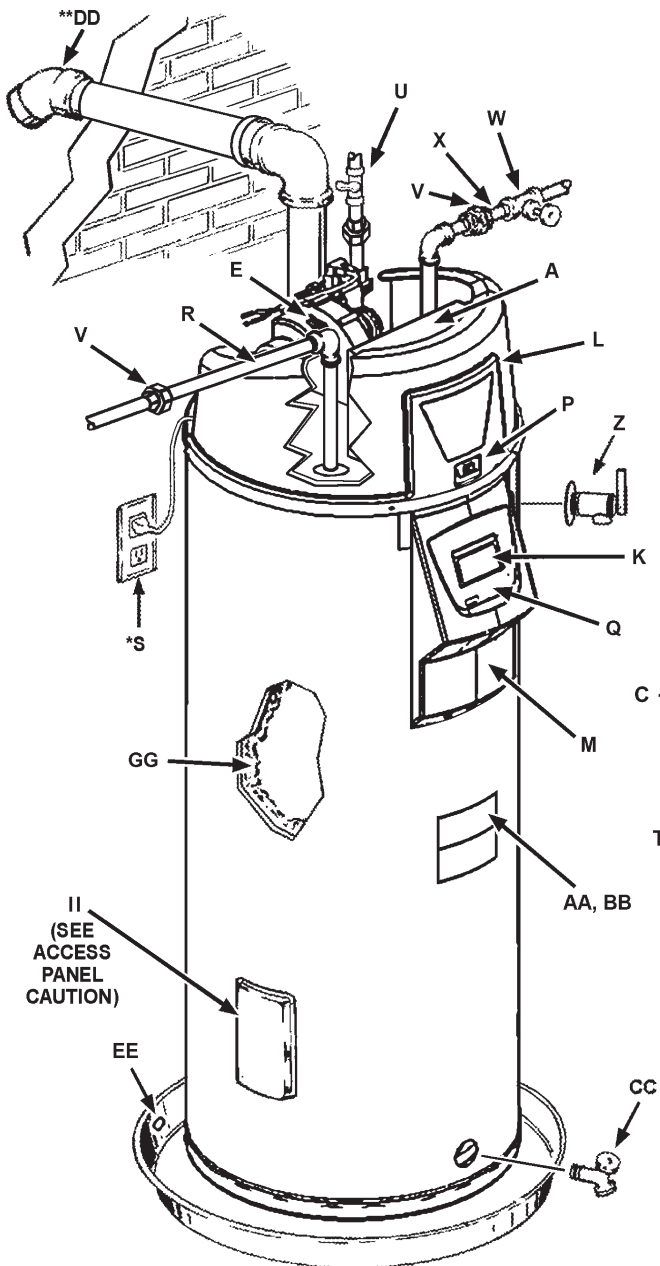

\* CAUTION HARNESS HAS 120 VAC. IN OPERATION.

\*\* See "Planning the Vent System," "Installation of Vent System" and "Condensate" for more information.

FIGURE 1.

# INSTALLATION CONSIDERATIONS

## ROUGH IN DIMENSIONS

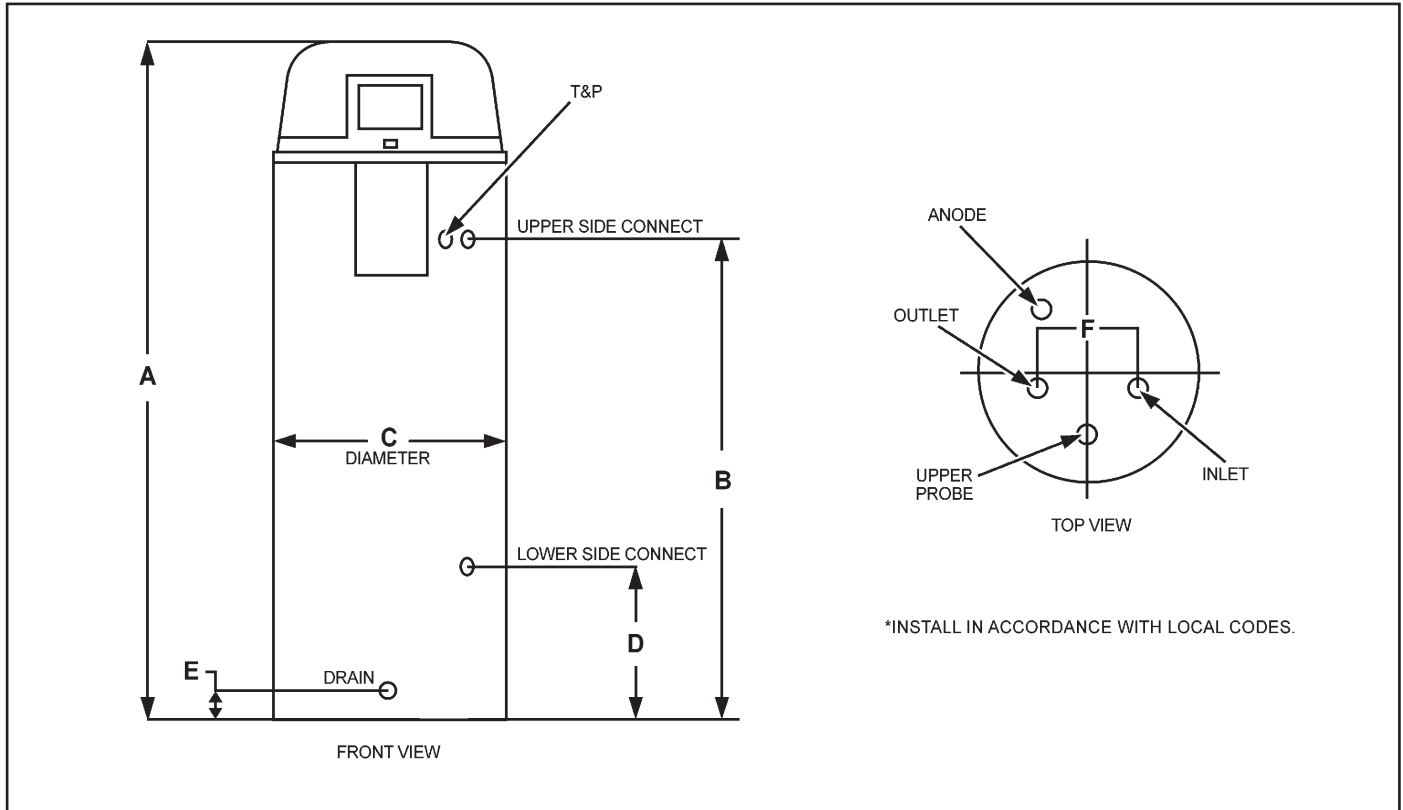

\*INSTALL IN ACCORDANCE WITH LOCAL CODES.

FIGURE 1A.

### Rough-In-Dimensions

Model	Units	A	B	C	D	E	F
100	Inches	68.50	49.25	22.00	15.75	3.00	8.00
	cm	174	125.09	55.88	40.00	7.62	20.32

Top/Side Inlet and Outlet: 3/4" NPT

Gas Inlet: 1/2" NPT

### Capacity, Gas and Electrical Characteristics

Model	Approximate Capacity		Manifold Pressure			Electrical Characteristics	
	U.S. Gals.	Liters	Gas Type	"WC	kPA	Volts/Hz	Amperes
100	50	189	Nat./LP	0"	0"	120/60	<5

All models - Maximum Supply Pressure: 14 inches W.C. (3.48kPa)

Minimum Supply Pressure for Natural Gas: 3.50" (.87kPa)

Minimum Supply Pressure for Propane Gas: 8.00" (1.99kPa)

Minimum pressure must be maintained under both load and no load (dynamic and static) conditions.

### Recovery Capacities - U.S. Gallons/Hr. and Liters/Hr. at Temperature Rise Indicated

Model	Input		Temp. Rise	Recovery Capacities													
	Rating (Btu/hr)	Rating (kW)		F	30	40	50	60	70	80	90	100	110	120	130	140	
				C	17	22	28	33	39	44	50	56	61	67	72	78	
100	100,000	29.3	GPH	387	291	233	194	166	145	129	116	106	97	90	83		
			LPH	1465	1102	882	734	628	549	488	439	401	367	341	314		

Recovery capacity based on 96% thermal efficiency

## INSTALLATION REQUIREMENTS FOR THE COMMONWEALTH OF MASSACHUSETTS

For all side wall terminated, horizontally vented power vent, direct vent, and power direct vent gas fueled water heaters installed in every dwelling, building or structure used in whole or in part for residential purposes, including those owned or operated by the Commonwealth and where the side wall exhaust vent termination is less than seven (7) feet above finished grade in the area of the venting, including but not limited to decks and porches, the following requirements should be satisfied:

**INSTALLATION OF CARBON MONOXIDE DETECTORS** At the time of installation of the side wall horizontal vented gas fueled equipment, the installing plumber or gasfitter should observe that a hard wired carbon monoxide detector with an alarm and battery back-up is installed on the floor level where the gas equipment is to be installed. In addition, the installing plumber or gasfitter should observe that a battery operated or hard wired carbon monoxide detector with an alarm is installed on each additional level of the dwelling, building or structure served by the sidewall horizontal vented gas fueled equipment. It should be the responsibility of the property owner to secure the services of qualified licensed professionals for the installation of hard wired carbon monoxide detectors.

In the event that the side wall horizontally vented gas fueled equipment is installed in a crawl space or an attic, the hard wired carbon monoxide detector with alarm and battery back-up may be installed on the next adjacent floor level.

In the event that the requirements of this subdivision can not be met at the time of completion of installation, the owner should have a period of thirty (30) days to comply with the above requirements provided that during said thirty (30) day period, a battery operated carbon monoxide detector with an alarm should be installed.

**APPROVED CARBON MONOXIDE DETECTORS** Each carbon monoxide detector as required in accordance with the above provisions should comply with NFPA 720 and be ANSI/UL 2034 listed and CSA certified.

**SIGNAGE** A metal or plastic identification plate should be permanently mounted to the exterior of the building at a minimum height of eight (8) feet above grade directly in line with the exhaust vent terminal for the horizontally vented gas fueled heating appliance or equipment. The sign should read, in print size no less than one-half (1/2) inch in size, **“GAS VENT DIRECTLY BELOW. KEEP CLEAR OF ALL OBSTRUCTIONS.”**

**INSPECTION** The state or local gas inspector of the side wall horizontally vented gas fueled equipment should not approve the installation unless, upon inspection, the inspector observes carbon monoxide detectors and signage installed in accordance with the provisions of 248 CMR 5.08(2)(a) 1 through 4.

**EXEMPTIONS:** The following equipment is exempt from 248 CMR 5.08(2)(a)1 through 4:

1. The equipment listed in Chapter 10 entitled “Equipment Not Required To Be Vented” in the most current edition of NFPA 54 as adopted by the Board; and
2. Product Approved side wall horizontally vented gas fueled equipment installed in a room or structure separate from the dwelling, building, or structure used in whole or in part for residential purposes.

**MANUFACTURER REQUIREMENTS - GAS EQUIPMENT VENTING SYSTEM PROVIDED** When the manufacturer of Product Approved side wall horizontally vented gas equipment provides a venting system design or venting system components with the equipment, the instructions provided by the manufacturer for installation of the equipment and the venting system should include:

1. Detailed instructions for the installation of the venting system design or the venting system components; and
2. A complete parts list for the venting system design or venting system.

**MANUFACTURER REQUIREMENTS - GAS EQUIPMENT VENTING SYSTEM NOT PROVIDED** When the manufacturer of a Product Approved side wall horizontally vented gas fueled equipment does not provide the parts for venting the flue gases, but identifies “special venting systems,” the following requirements should be satisfied by the manufacturer:

1. The referenced “special venting system” instructions should be included with the appliance or equipment installation instructions; and
2. The “special venting systems” should be Product Approved by the Board, and the instructions for that system should include a parts list and detailed installation instructions.

A copy of all installation instructions for all Product Approved side wall horizontally vented gas fueled equipment, all venting instructions, all parts lists for venting instructions, and/or all venting design instructions should remain with the appliance or equipment at the completion of the installation.



## WATER PIPING - MIXING VALVE USAGE

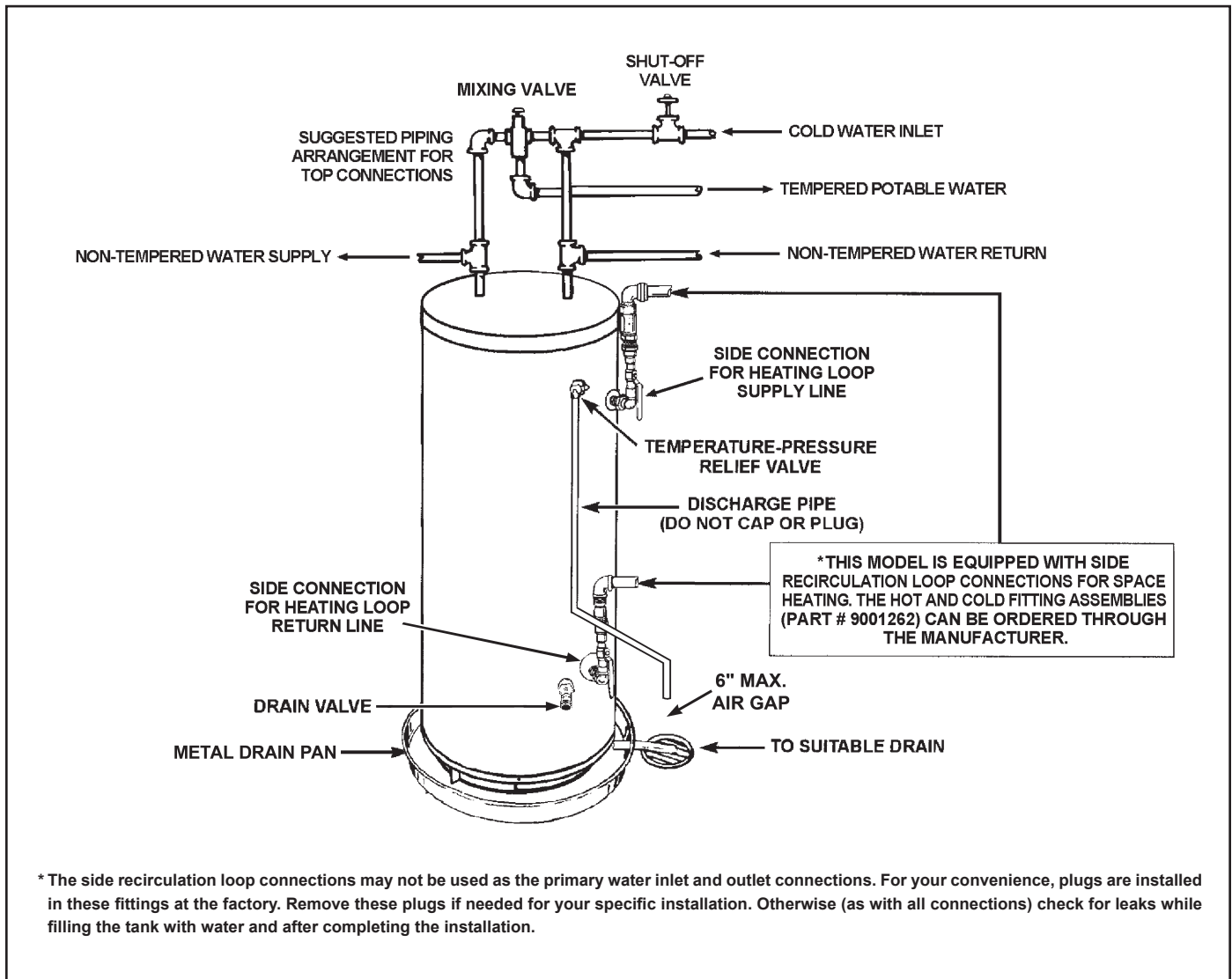

FIGURE 2.

This appliance has been design certified as complying with American National Standard/CSA Standard for water heaters and is considered suitable for:

**Water (Potable) Heating and Space Heating:** All models are considered suitable for water (potable) heating and space heating.

	<p><b>⚠ DANGER</b></p> <p>Water temperature over 125°F (52°C) can cause severe burns instantly resulting in severe injury or death.</p> <p>Children, the elderly, and the physically or mentally disabled are at highest risk for scald injury.</p> <p>Feel water before bathing or showering.</p> <p>Temperature limiting valves are available.</p> <p>Read instruction manual for safe temperature setting.</p>
--	---

### HOTTER WATER CAN SCALD:

Water heaters are intended to produce hot water. Water heated to a temperature which will satisfy space heating, clothes washing, dish washing, and other sanitizing needs can scald and permanently injure you upon contact. Some people are more likely to be permanently injured by hot water than others. These include the elderly, children, and the physically or developmentally disabled. If anyone using hot water from this heater fits into one of these groups or if there is a local code or state law requiring a certain temperature water at the hot water tap, then you must take special precautions. In addition to using the lowest possible temperature setting that satisfies your hot water needs, a means such as a Mixing Valve, should be used at the hot water taps used by these people or at the water heater, see Figure 2. Mixing valves are available at plumbing supply or hardware stores. Consult a Qualified Installer or Service Agency. Follow mixing valve manufacturer's instructions for installation of the valves. Before changing the factory setting on the thermostat, read the "Temperature Regulation" section in this manual.

## FACTS TO CONSIDER ABOUT THE LOCATION

Carefully choose an indoor location for the new water heater, because the placement is a very important consideration for the safety of the occupants in the building and for the most economical use of the appliance. **This water heater is not for use in manufactured (mobile) homes or outdoor installation.**

Whether replacing an old water heater or putting the water heater in a new location, the following critical points must be observed:

1. Select a location indoors as close as practical to the vent terminal or location to which the water heater vent piping is going to be connected, and as centralized with the water piping system as possible.
2. Selected location must provide adequate clearances for servicing and proper operation of the water heater.

<b>CAUTION</b>
<b>Property Damage Hazard</b>
<ul style="list-style-type: none"> <li>• All water heaters eventually leak.</li> <li>• Do not install without adequate drainage.</li> </ul>

Installation of the water heater must be accomplished in such a manner that if the tank or any connections should leak, the flow will not cause damage to the structure. For this reason, it is not advisable to install the water heater in an attic or upper floor. When such locations cannot be avoided, a suitable metal drain pan should be installed under the water heater. Drain pans are available at your local hardware store. Such a drain pan must have a clearance of at least 1.0" (2.5cm) greater than any point on the water heater's outer jacket and must be piped to an adequate drain. The pan must not restrict combustion air flow. For example, if a circular pan is used, it must be a minimum of 27" (69cm) in diameter. See Figure 1.

Water heater life depends upon water quality, water pressure and the environment in which the water heater is installed. Water heaters are sometimes installed in locations where leakage may result in property damage, even with the use of a drain pan piped to a drain. However, unanticipated damage can be reduced or prevented by a leak detector or water shut-off device used in conjunction with a piped drain pan. These devices are available from some plumbing supply wholesalers and retailers, and detect and react to leakage in various ways:

- Sensors mounted in the drain pan that trigger an alarm or turn off the incoming water to the water heater when leakage is detected.
- Sensors mounted in the drain pan that turn off the water supply to the entire building when water is detected in the drain pan.
- Water supply shut-off devices that activate based on the water pressure differential between the cold water and hot water pipes connected to the water heater.
- Devices that will turn off the gas supply to a gas water heater while at the same time shutting off its water supply.

**INSTALLATIONS IN AREAS WHERE FLAMMABLE LIQUIDS (VAPORS) ARE LIKELY TO BE PRESENT OR STORED (GARAGES, STORAGE AND UTILITY AREAS, ETC.):** Flammable liquids (such as gasoline, solvents, propane (LP or butane, etc.) and other substances (such as adhesives, etc.) emit flammable vapors which can be ignited by a gas water heater's hot surface igniter or main burner. The resulting flashback and fire can cause death or serious burns to anyone in the area.

Also, the water heater must be located and/or protected so it is not subject to physical damage by a moving vehicle.

<b>⚠ WARNING</b>	
<b>Fire or Explosion Hazard</b>	
<ul style="list-style-type: none"> <li>• Do not store or use gasoline or other flammable vapors and liquids in the vicinity of this or any other appliance.</li> <li>• Avoid all ignition sources if you smell LP gas.</li> <li>• Do not expose water heater control to excessive gas pressure.</li> <li>• Use only gas shown on rating plate.</li> <li>• Maintain required clearances to combustibles.</li> <li>• Keep ignition sources away from faucets after extended period of non-use.</li> </ul>	
	<p>Read instruction manual before installing, using or servicing water heater.</p>
	

<b>⚠ DANGER</b>	
	
<p><b>⚠ Vapors from flammable liquids may explode and catch fire causing death or severe burns.</b></p> <p>Do not use or store flammable products such as gasoline, solvents or adhesives in the same room or area near the water heater.</p> <p>Keep flammable products:</p> <ol style="list-style-type: none"> <li>1. far away from heater,</li> <li>2. in approved containers,</li> <li>3. tightly closed and</li> <li>4. out of children's reach.</li> </ol>	<p>Water heater has a main burner and hot surface igniter. The hot surface igniter:</p> <ol style="list-style-type: none"> <li>1. can come on at any time and</li> <li>2. will ignite flammable vapors.</li> </ol> <p>Vapors:</p> <ol style="list-style-type: none"> <li>1. cannot be seen,</li> <li>2. are heavier than air,</li> <li>3. go a long way on the floor and</li> <li>4. can be carried from other rooms to the hot surface igniter by air currents.</li> </ol>
<p><b>Installation:</b> Do not install the water heater where flammable products will be stored or used unless the main burner and hot surface igniter are</p>	
<p>at least 18" above the floor. This will reduce, but not eliminate, the risk of vapors being ignited by the main burner or hot surface igniter.</p>	

	<b>⚠ WARNING</b>
	<b>Fire Hazard</b>
	<p>For continued protection against risk of fire:</p> <ul style="list-style-type: none"> <li>• Do not install water heater on carpeted floor.</li> <li>• Do not operate water heater if flood damaged.</li> </ul>

This water heater must not be installed directly on carpeting. Carpeting must be protected by metal or wood panel beneath the appliance extending beyond the full width and depth of the appliance by at least 3" (7.6 cm) in any direction, or if the appliance is installed

in an alcove or closet, the entire floor must be covered by the panel. Failure to heed this warning may result in a fire hazard.



Minimum clearances between the water heater and combustible construction are 0 inch at the sides and rear, 5.5" (14.0 cm) from the front and 12" (30.5 cm) from the top. (Standard clearance.) If clearances stated on the heater differ from standard clearances, install water heater according to clearances stated on the heater.

Adequate clearance 24" (61.0 cm) for servicing this appliance should be considered before installation, such as changing the anodes, etc.

A minimum clearance of 5.5" (14.0 cm) must be allowed for access to replaceable parts such as the thermostats, drain valve and relief valve.

When installing the heater, consideration must be given to proper location. Location selected should be as close to the wall as practicable and as centralized with the water piping system as possible.

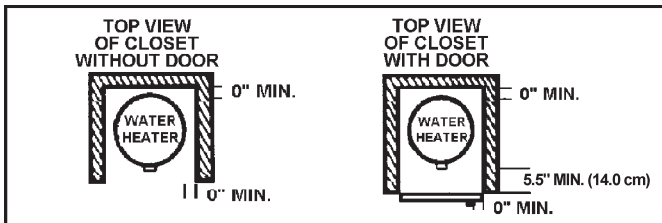
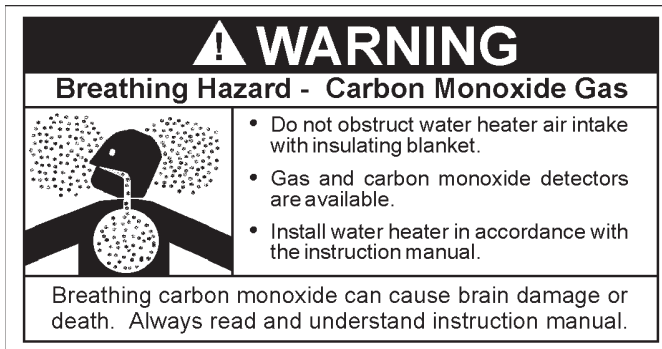

FIGURE 4.

## INSULATION BLANKETS

Insulation blankets are available to the general public for external use on gas water heaters but are not necessary with these products. The purpose of an insulation blanket is to reduce the standby heat loss encountered with storage tank heaters. Your water heater meets or exceeds the Energy Policy Act standards with respect to insulation and standby loss requirements, making an insulation blanket unnecessary.

Should you choose to apply an insulation blanket to this heater, you should follow these instructions (For identification of components mentioned below, see Figure 1). Failure to follow these instructions can restrict the air flow required for proper combustion, potentially resulting in fire, asphyxiation, serious personal injury or death.



- Do not apply insulation to the top of the water heater, as this will interfere with safe operation of the blower assembly.
- Do not cover the outer door, thermostat or temperature & pressure relief valve.
- Do not allow insulation to come within 2" (5.1 cm) of the floor to prevent blockage of combustion air flow to the burner.
- Do not cover the instruction manual. Keep it on the side of the water heater or nearby for future reference.
- Do obtain new warning and instruction labels from the manufacturer

- for placement on the blanket directly over the existing labels.
- Do inspect the insulation blanket frequently to make certain it does not sag, thereby obstructing combustion air flow.

## COMBUSTION AIR AND VENTILATION

A gas water heater cannot operate properly without the correct amount of air for combustion. Do not install in a confined area such as a closet, unless you provide air as shown in the "Facts to Consider About Location" section. Never obstruct the flow of ventilation air. If you have any doubts or questions at all, call your gas supplier. Failure to provide the proper amount of combustion air can result in a fire or explosion and cause death, serious bodily injury, or property damage.

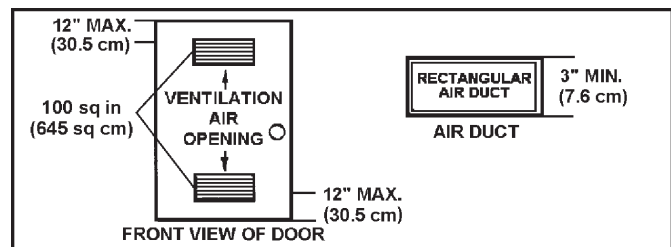
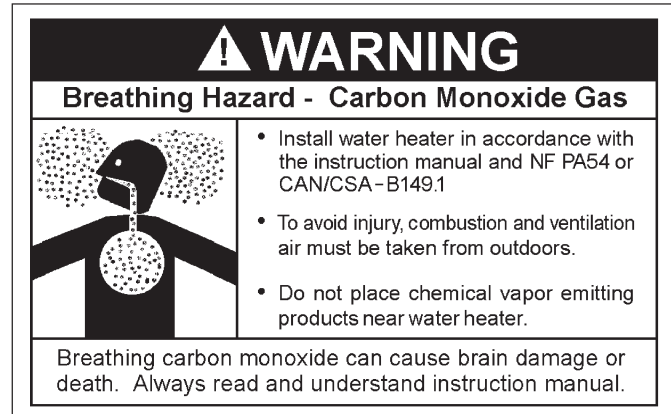

FIGURE 5.

If this water heater will be used in beauty shops, barber shops, cleaning establishments, or self-service laundries with dry cleaning equipment, it is imperative that the water heater (s) be installed direct vent so that all air for combustion and ventilation is taken from outdoors.

Propellants of aerosol sprays and volatile compounds, (cleaners, chlorine based chemicals, refrigerants, etc.) in addition to being highly flammable in many cases, will also react to form corrosive hydrochloric acid when exposed to the combustion products of the water heater. The results can be hazardous, and also cause product failure.

## APPLIANCES IN UNCONFINED SPACES

**UNCONFINED SPACE** is space whose volume is not less than 50 cubic feet per 1,000 Btu per hour (4.8 cubic meters per kW) of the aggregate input rating of all appliances installed in that space. Rooms communicating directly with the space in which the appliances are installed, through openings not furnished with doors, are considered a part of the unconfined space.

In unconfined spaces in buildings, infiltration may be adequate to provide air for combustion, ventilation and dilution of flue gases. However, in buildings of tight construction (for example, weather stripping, heavily insulated, caulked, vapor barrier, etc.), additional air may need to be provided using the methods described in "Appliances in Confined Space" that follows."

## APPLIANCES IN CONFINED SPACES

**CONFINED SPACE** is a space whose volume is less than 50 cubic feet per 1,000 Btu per hour (4.8 cm per kW) of the aggregate input rating of all appliances installed in that space.

When drawing combustion air from inside a conventionally constructed building to a confined space, such a space should be provided with two permanent openings. ONE WITHIN 12 INCHES (30 cm) OF THE ENCLOSURE TOP AND ONE WITHIN 12 INCHES (30 cm) OF THE ENCLOSURE BOTTOM. Each opening should have

a free area of one square inch per 1000 Btu/hr (22 cm<sup>2</sup>/kW) of the total input of all appliances in the enclosure, but not less than 100 square inches (645 cm<sup>2</sup>).

If the confined space is within a building of tight construction, air for combustion and ventilation must be obtained from outdoors. When directly communicating with the outdoors or communicating through vertical ducts, two permanent openings, located in the above manner, should be provided. Each opening should have a free area of not less than one square inch per 4000 Btu/hr (5.5 cm<sup>2</sup>/kW) of total input of all appliances in the enclosure. If horizontal ducts are used, each opening should have a free area of not less than one square inch per 2000 Btu/hr (11 cm<sup>2</sup>/kW) of the total input of all appliances in the enclosure.

**A. ALL AIR FROM INSIDE BUILDINGS:** (See Figure 5 and 6)

The confined space should be provided with two permanent openings communicating directly with an additional room(s) of sufficient volume so that the combined volume of all spaces meets the criteria for an unconfined space. The total input of all gas utilization equipment installed in the combined space should be considered in making this determination. Each opening should have a minimum free area of one square inch per 1,000 Btu per hour (22 cm<sup>2</sup>/kW) of the total input rating of all gas utilization equipment in the confined space, but not less than 100 square inches (645 cm<sup>2</sup>). One opening should commence within 12 inches (30 cm) of the top and one commencing within 12 inches (30 cm) of the bottom of the enclosures.

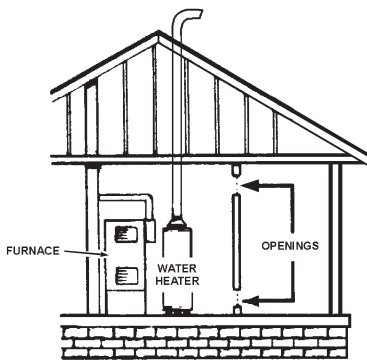
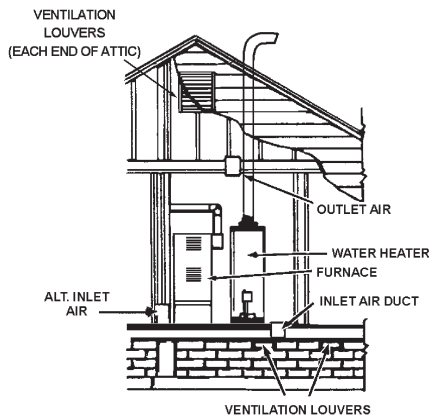

**FIGURE 6.**

**B. ALL AIR FROM OUTDOORS:** (See Figures 7, 8 and 9)

The confined space should be provided with two permanent openings, one commencing within 12 inches (30 cm) of top and one commencing within 12 inches (30 cm) from the bottom of the enclosure. The openings should communicate directly, or by ducts, with the outdoors or spaces (crawl or attic) that freely communicate with the outdoors.

1. When directly communicating with the outdoors, each opening should have a minimum free area of 1 square inch per 4,000 Btu per hour (5.5 cm<sup>2</sup>/kW) of total input rating of all equipment in the enclosure, see Figure 7.



**FIGURE 7.**

2. When communicating with the outdoors through vertical ducts, each opening should have a minimum free area of 1 square inch per 4,000 Btu per hour (5.5 cm<sup>2</sup>/kW) of total input rating of all equipment in the enclosure, see Figure 8.

3. When communicating with the outdoors through horizontal ducts, each opening should have a minimum free area of 1 square inch per 2,000 Btu per hour (11 cm<sup>2</sup>/kW) of total input rating of all equipment in the enclosure, see Figure 9A.

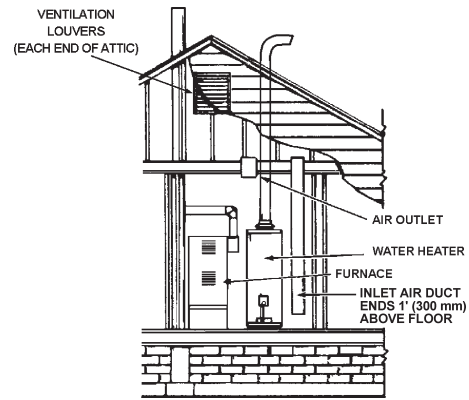

**FIGURE 8.**

4. When ducts are used, they should be of the same cross-sectional area as the free area of the openings to which they connect. The minimum short side dimension of rectangular air ducts should not be less than 3 inches (7.6 cm), see Figure 9A.

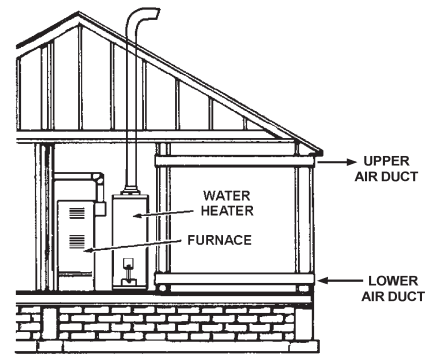

**FIGURE 9A.**

5. Alternatively a single permanent opening may be used when communicating directly with the outdoors, or with spaces that freely communicate with the outdoors. The opening should have a minimum free area of 1 square inch per 3,000 BTU per hour (8.3 cm<sup>2</sup>/kW) of total input rating of all equipment in enclosure. See Figure 9B.

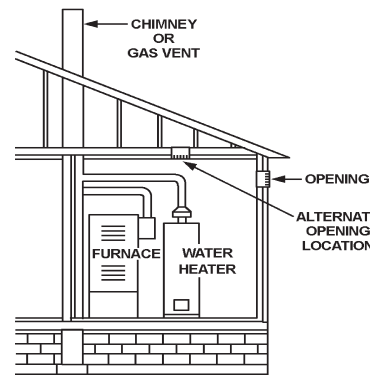

**FIGURE 9B.**

6. Louvers and Grilles: In calculating free area, consideration should be given to the blocking effect of louvers, grilles or screens protecting openings. Screens used should not be smaller than 1/4 inch (6.4 mm) mesh. If the free area through a design of louver or grille is known, it should be used in calculating the size opening required to provide the free area specified. If the design and free area is not known, it may be assumed that wood louvers will be 20-25 percent free area and metal louvers and grilles will have 60-75 percent free area. Louvers and grilles should be fixed in the open position or interlocked with the equipment so that they are opened automatically during equipment operation.
7. Special Conditions Created by Mechanical Exhausting or Fireplaces: operation of exhaust fans, ventilation systems, clothes dryers or fireplaces may create conditions requiring special attention to avoid unsatisfactory operation of installed gas utilization equipment.

# INSTALLING THE NEW WATER HEATER

## CHEMICAL VAPOR CORROSION

CORROSION OF THE FLUEWAYS AND VENT SYSTEM MAY OCCUR IF AIR FOR COMBUSTION CONTAINS CERTAIN CHEMICAL VAPORS. SUCH CORROSION MAY RESULT IN FAILURE AND RISK OF ASPHYXIATION.

Spray can propellants, cleaning solvents, refrigerator and air conditioning refrigerants, swimming pool chemicals, calcium and sodium chloride (water softener salt), waxes, and process chemicals are typical compounds which are potentially corrosive.

Do not store products of this sort near the heater. Also, air which is brought in contact with the heater should not contain any of these chemicals. If necessary, uncontaminated air should be obtained from remote or outside sources. The limited warranty is voided when failure of water heater is due to a corrosive atmosphere. (See limited warranty for complete terms and conditions).

## WATER PIPING

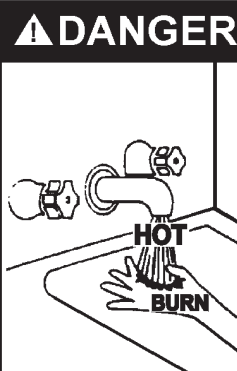
	<p><b>⚠ DANGER</b> Water temperature over 125°F (52°C) can cause severe burns instantly resulting in severe injury or death.</p> <p>Children, the elderly, and the physically or mentally disabled are at highest risk for scald injury.</p> <p>Feel water before bathing or showering.</p> <p>Temperature limiting valves are available.</p> <p>Read instruction manual for safe temperature setting.</p>
--	--

### HOTTER WATER CAN SCALD:

Water heaters are intended to produce hot water. Water heated to a temperature which will satisfy space heating, clothes washing, dish washing, cleaning and other sanitizing needs can scald and permanently injure you upon contact. Some people are more likely to be permanently injured by hot water than others. These include the elderly, children, the physically or developmentally disabled. If anyone using hot water fits into one of these groups or if there is a local code or state law requiring a certain temperature water at the hot water tap, then you must take special precautions. In addition to using the lowest possible temperature setting that satisfies your hot water needs, a means such as a \*mixing valve, should be used at the hot water taps used by these people or at the water heater, see Figure 2. Valves for reducing point of use temperature by mixing cold and hot water are also available:

Consult a Qualified Installer or Service Agency. Follow manufacturer's instructions for installation of the valves. Before changing the factory setting on the thermostat, read the "Temperature Regulation" section in this manual.

<p><b>⚠ WARNING</b></p> <p><b>Toxic Chemical Hazard</b></p>
<ul style="list-style-type: none"> <li>• Do not connect to non-potable water system.</li> </ul>

This water heater should not be connected to any heating systems or component(s) used with a non-potable water heating appliance.

All piping components connected to this unit for space heating applications should be suitable for use with potable water.

Toxic chemicals, such as those used for boiler treatment should not be introduced into this system.

When the system requires water for space heating at temperatures higher than required for domestic water purposes, a mixing valve must be installed. Please refer to Figure 2 for suggested piping arrangement.

## CLOSED WATER SYSTEMS

Water supply systems may, because of code requirements or such conditions as high line pressure, among others, have installed devices such as pressure reducing valves, check valves, and back flow preventers. Devices such as these cause the water system to be a closed system.

## THERMAL EXPANSION

As water is heated, it expands (thermal expansion). In a closed system the volume of water will grow when it is heated. As the volume of water grows there will be a corresponding increase in water pressure due to thermal expansion. Thermal expansion can cause premature tank failure (leakage). This type of failure is not covered under the limited warranty. Thermal expansion can also cause intermittent temperature-pressure relief valve operation: water discharged from the valve due to excessive pressure build up. The temperature-pressure relief valve is not intended for the constant relief of thermal expansion. This condition is not covered under the limited warranty.

A properly sized thermal expansion tank should be installed on all closed systems to control the harmful effects of thermal expansion. Contact a local plumbing service agency to have a thermal expansion tank installed.

<p><b>CAUTION</b></p> <p><b>Property Damage Hazard</b></p>
<ul style="list-style-type: none"> <li>• Avoid water heater damage.</li> <li>• Install thermal expansion tank if necessary.</li> <li>• Do not apply heat to cold water inlet.</li> <li>• Contact qualified installer or service agency.</li> </ul>

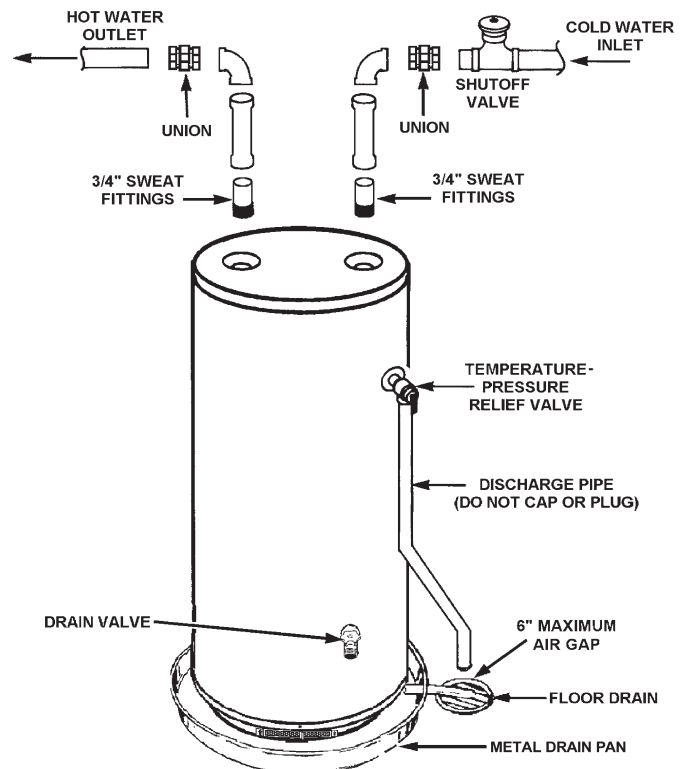

FIGURE 10.

**NOTE:** To protect against untimely corrosion of hot and cold water fittings, it is strongly recommended that di-electric unions or couplings be installed on this water heater when connected to copper pipe, see Figure 2 also.

Figures 2 and 10 show the typical attachment of the water piping to the water heater. The water heater is equipped with 3/4 inch NPT water connections.

**NOTE:** If using copper tubing, solder tubing to an adapter before attaching the adapter to the water heater connections. Do not solder the water lines directly to the water heater connections. It will harm the dip tube and damage the tank.

**T & P Valve and Pipe Insulation (if supplied)**

Remove insulation for T & P valve and pipe connections from carton.

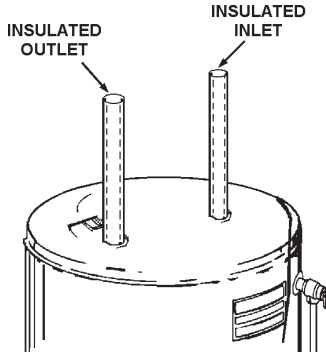

**FIGURE 11.**

Fit pipe insulation over the incoming cold water line and the hot water line. Make sure that the insulation is against the top cover of the heater. Fit T & P valve insulation over valve. Make sure that the insulation does not interfere with the lever of the T & P valve.

Secure all insulation using tape.

**TEMPERATURE-PRESSURE RELIEF VALVE**

If replaced, the valve must meet the requirements of local codes, but not less than a combination temperature and pressure relief valve certified as indicated in the above paragraph.

The valve must be marked with a maximum set pressure not to exceed the marked hydrostatic working pressure of the water heater (150 psi = 1,035 kPa) and a discharge capacity not less than the water heater Btu/hr input rate as shown on the water heater's model rating plate.

For safe operation of the water heater, the relief valve must not be removed from its designated opening nor plugged.

The temperature-pressure relief valve must be installed directly into the fitting of the water heater designed for the relief valve. Position the valve downward and provide tubing so that any discharge will exit only within 6 inches (15.2 cm) above, or at any distance below the structural floor. Be certain that no contact is made with any live electrical part. The discharge opening must not be blocked or reduced in size under any circumstances. Excessive length, over 30 feet (9.14 m), or use of more than four elbows can cause restriction and reduce the discharge capacity of the valve, see Figures 10.

No valve or other obstruction is to be placed between the relief valve and the tank. Do not connect tubing directly to discharge drain unless a 6" (15.2 cm) air gap is provided. To prevent bodily injury, hazard to life, or property damage, the relief valve must be allowed to discharge water in quantities should circumstances demand. If the discharge pipe is not connected to a drain or other suitable means, the water flow may cause property damage.

<b>CAUTION</b>
<b>Water Damage Hazard</b>
<ul style="list-style-type: none"> <li>• Temperature-pressure relief valve discharge pipe must terminate at adequate drain.</li> </ul>

	<b>⚠ WARNING</b>
	<b>Explosion Hazard</b>
	<ul style="list-style-type: none"> <li>• Temperature-pressure relief valve must comply with ANSI Z21.22- CSA 4.4 and ASME code.</li> <li>• Properly sized temperature-relief valve must be installed in opening provided.</li> <li>• Can result in overheating and excessive tank pressure.</li> <li>• Can cause serious injury or death.</li> </ul>

This heater is provided with a properly certified combination temperature - pressure relief valve by the manufacturer.

The valve is certified by a nationally recognized testing laboratory that maintains periodic inspection of production of listed equipment of materials as meeting the requirements for Relief Valves for Hot Water Supply Systems, ANSI Z21.22 • CSA 4.4, and the code requirements of ASME.

**The Discharge Pipe:**

- Should not be smaller in size than the outlet pipe size of the valve, or have any reducing couplings or other restrictions.
- Should not be plugged or blocked.
- Should be of material listed for hot water distribution.
- Should be installed so as to allow complete drainage of both the temperature-pressure relief valve, and the discharge pipe.
- Should terminate at an adequate drain or external to the building.
- Should not have any valve between the relief valve and tank.

<b>⚠ DANGER</b>	<p>Water temperature over 125°F (52°C) can cause severe burns instantly resulting in severe injury or death.</p> <p>Children, the elderly, and the physically or mentally disabled are at highest risk for scald injury.</p> <p>Feel water before bathing or showering.</p> <p>Temperature limiting valves are available.</p> <p>Read instruction manual for safe temperature setting.</p>

The temperature-pressure relief valve must be manually operated at least once a year, see Figure 28. Caution should be taken to ensure that (1) no one is in front of or around the outlet of the temperature-pressure relief valve discharge line, and (2) the water manually discharged will not cause any bodily injury or property damage because the water may be extremely hot.

If after manually operating the valve, it fails to completely reset and continues to release water, immediately close the cold water inlet to the water heater, follow the draining instructions, and replace the temperature-pressure relief valve with a new one.

## GAS PIPING

	<b>⚠ WARNING</b>
	<b>Fire and Explosion Hazard</b>

- Do not use water heater with any gas other than the gas shown on the rating plate.
- Excessive pressure to gas control valve can cause serious injury or death.
- Turn off gas lines during installation.
- Contact qualified installer or service agency.

Make sure gas supplied is same type listed on model rating plate. The inlet gas pressure must not exceed 14 inch water column (3.5 kPa) for natural and propane gas (L.P.). The minimum inlet gas pressure shown on rating plate is that which will permit firing at rated input.

All gas piping must comply with local codes and ordinances or with the National Fuel Gas Code (ANSI Z223.1/ NFPA-54) or the Natural Gas and Propane Installation Code (CAN/CSA B149.1) whichever applies. Copper or brass tubing and fittings (except tin lined copper tubing) should not be used.

If the gas control valve is subjected to pressures exceeding 1/2 psi (3.5 kPa), the damage to the gas control valve could result in a fire or explosion from leaking gas.

If the main gas line Shut-off serving all gas appliances is used, also turn "off" the gas at each appliance. Leave all gas appliances shut "off" until the water heater installation is complete.

A gas line of sufficient size must be run to the water heater. Consult the current edition of National Fuel Gas Code (ANSI Z223.1/NFPA 54) or the Natural Gas and Propane Installation Code (CAN/CSA B149.1) and your gas supplier concerning pipe size.

There must be:

- A readily accessible manual shut off valve in the gas supply line serving the water heater, and
- A drip leg (sediment trap) ahead of the gas control valve to help prevent dirt and foreign materials from entering the gas control valve.
- A flexible gas connector or a ground joint union between the shut off valve and control valve to permit servicing of the unit.

Be sure to check all the gas piping for leaks before lighting the water heater. Use a soapy water solution, not a match or open flame. Rinse off soapy solution and wipe dry.

## HIGH ALTITUDE INSTALLATIONS

<b>⚠ WARNING</b>	
<b>Breathing Hazard - Carbon Monoxide Gas</b>	
	<ul style="list-style-type: none"> <li>• Special consideration must be taken with installations above 10,100 feet (3,079m).</li> <li>• Please contact an AO Smith qualified service agent to obtain the proper setup and instructions before lighting.</li> <li>• Failure to implement the proper setup will result in improper and inefficient operation of the appliance resulting in production of increased levels of carbon monoxide gas in excess of the safe limits which could result in serious personal injury or death.</li> </ul>
Breathing carbon monoxide can cause brain damage or death. Always read and understand instruction manual.	

Rated inputs are suitable up to 10,100 feet (3,079m) elevation. Consult the factory for installation at altitudes over 10,100 feet (3,079m).

**WARNING: THIS HIGH EFFICIENCY WATER HEATER IS CERTIFIED FOR USE WITHOUT MODIFICATION FOR AN ALTITUDE OF 10,100 FEET (3,079 METERS). INSTALLATIONS ABOVE THESE ALTITUDES MAY REQUIRE REPLACEMENT OF BURNER ORIFICE. CALL THE TECHNICAL CENTER AT (800) 365-0024 FOR REQUIREMENTS.**

Some gas utility companies derate their gas for altitude, making it unnecessary to install high altitude orifices. Call the local gas or utility company to verify BTU content.

Due to the input ration reduction at high altitudes, the output rating of the appliance is also reduced and should be compensated for in the sizing of the equipment for applications.

	<b>⚠ WARNING</b>
	<b>Fire and Explosion Hazard</b>

- Use joint compound or tape compatible with propane.
- Leak test before operating heater.
- Disconnect gas piping and shut-off valve before pressure testing system.

Use pipe joint compound or teflon tape marked as being resistant to the action of petroleum [Propane (L.P.)] gases.

The appliance and its gas connection must be leak tested before placing the appliance in operation.

The appliance and its individual Shut-off valve should be disconnected from the gas supply piping system during any pressure testing of that system at test pressures in excess of 1/2 pound per square inch (3.5 kPa). It should be isolated from the gas supply piping system by closing its individual manual Shut-off valve during any pressure testing of the gas supply piping system at test pressures equal to or less than 1/2 pound per square inch (3.5 kPa).

**IMPORTANT: MAKE SURE THE GAS LINE IS PIPED IN WITH HARD PIPE. AVOID FLEX LINE CONSTRUCTION FOR GAS DUE TO POSSIBLE GAS FLOW PROBLEMS.**

## SEDIMENT TRAPS

	<b>⚠ WARNING</b>
	<b>Fire and Explosion Hazard</b>
	<ul style="list-style-type: none"><li>• Contaminants in gas lines can cause fire or explosion.</li><li>• Clean all gas piping before installation.</li><li>• Install drip leg in accordance with NFPA54 or CAN/CSA-B149.1.</li></ul>

A sediment trap should be installed as close to the gas inlet of the water heater as practical at the time of water heater installation. The sediment trap should be either a tee fitting with a capped nipple in the bottom outlet or other device recognized as an effective sediment trap.

Contaminants in the gas lines may cause improper operation of the gas control valve that may result in fire or explosion. Before attaching the gas line be sure that all gas pipe is clean on the inside. To trap any dirt or foreign material in the gas supply line, a drip leg (sometimes called a sediment trap) must be incorporated in the piping. The drip leg must be readily accessible. Install in accordance with the "Gas Piping" section. Refer to the current edition of the National Fuel Gas Code (ANSI Z223.1/NFPA 54) or the Natural Gas and Propane Installation Code (CAN/CSA B149.1).

## FILLING THE WATER HEATER

<b>CAUTION</b>
<b>Property Damage Hazard</b>
<ul style="list-style-type: none"><li>• Avoid water heater damage.</li><li>• Fill tank with water before operating.</li></ul>

Never use this water heater unless it is completely full of water. To prevent damage to the tank, the tank must be filled with water. Water must flow from the hot water faucet before turning "ON" gas to the water heater.

To fill the water heater with water:

1. Close the water heater drain valve by turning the handle to the right (clockwise). The drain valve is on the lower front of the water heater.
2. Open the cold water supply valve to the water heater.  
**NOTE: The cold water supply valve must be left open when the water heater is in use.**
3. To insure complete filling of the tank, allow air to exit by opening the nearest hot water faucet. Allow water to run until a constant flow is obtained. This will let air out of the water heater and the piping.
4. Check all water piping and connections for leaks. Repair as needed.

## VENTING

	<b>⚠ WARNING</b>
	<b>Breathing Hazard - Carbon Monoxide Gas</b>
	<ul style="list-style-type: none"><li>• Install vent system in accordance with codes.</li><li>• Do not operate water heater if flood damaged.</li><li>• Special Consideration must be taken with installations above 10,100' (3,078m) for standard models.</li><li>• Do not operate if soot buildup.</li><li>• Do not obstruct water heater air intake with insulating jacket.</li><li>• Do not place chemical vapor emitting products near water heater.</li><li>• Gas and carbon monoxide detectors are available.</li><li>• Never operate the heater unless it is vented to the outdoors and has adequate air supply to avoid risks of improper operation, fire, explosion or asphyxiation.</li><li>• Analyze the entire vent system to make sure that condensate will not become trapped in a section of vent pipe and therefore reduce the open cross sectional area of the vent.</li></ul>
<b>Breathing carbon monoxide can cause brain damage or death. Always read and understand instruction manual.</b>	

## VENT PIPE TERMINATION

The first step is to determine where the vent pipe will terminate. See Figures 19, 20, and 21. The vent may terminate through a sidewall as shown in Figure 19 or through the roof as shown in Figures 20 and 21.

The vent system must terminate so that proper clearances are maintained as cited in local codes or the current edition of the National Fuel Gas Code, (ANSI Z223.1, 12.9.1 through 12.9.4) or the Natural Gas and Propane Installation Code (CAN/CSA-B149.1).

Instructions on proper installation through a sidewall are provided in Figures 15A, 15B, 15C, and 15D.

Plan the vent system layout so that proper clearances are maintained from plumbing and wiring.

Vent pipes serving power vented appliances are classified by building codes as "vent connectors". Required clearances from combustible materials must be provided in accordance with information in this manual under FACTS TO CONSIDER ABOUT LOCATION and INSTALLING THE WATER HEATER, and with the National Fuel Gas Code and local codes.



## U.S. POWER VENT

**⚠ WARNING**  
**VENT HOOD(S) MAY BE**  
**EXTREMELY HOT**  
**DURING OPERATION.**

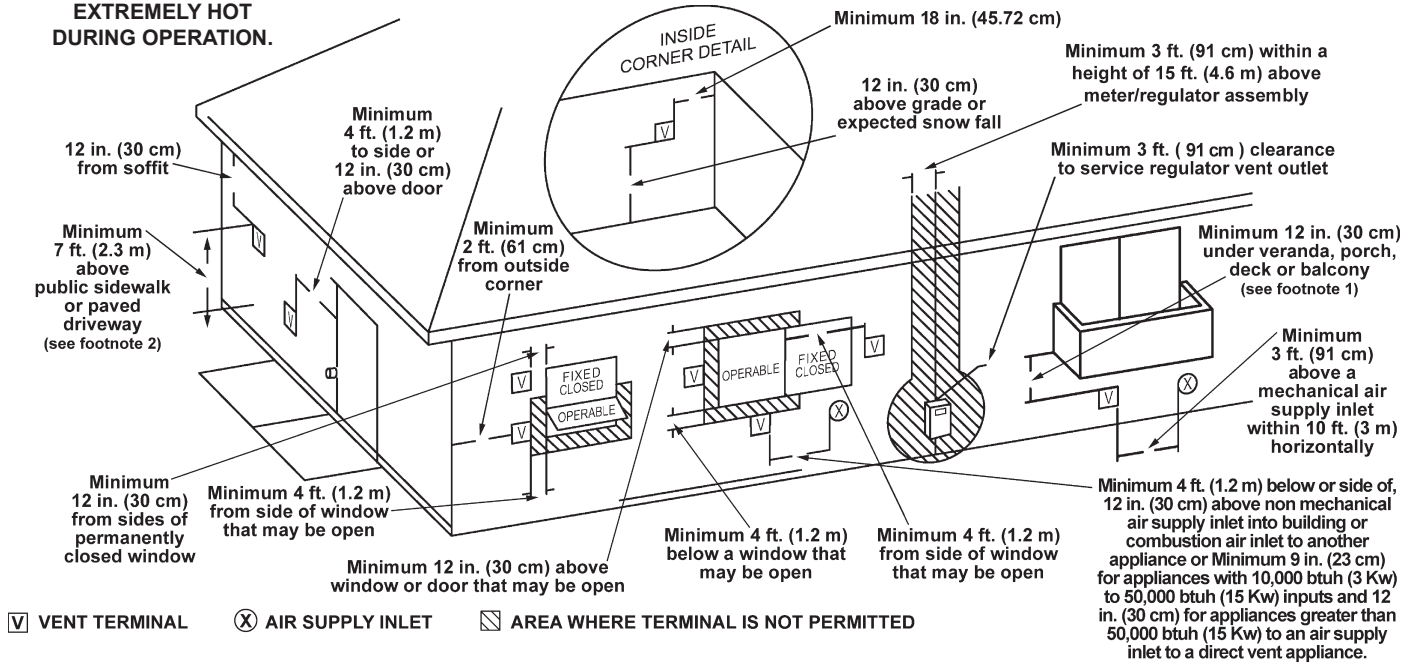

1. Permitted only if veranda, porch, deck or balcony is fully opened on a minimum of two sides beneath the floor.
2. A vent shall not terminate above a sidewalk or paved driveway that is located between two single family dwellings and serves both dwellings.

FIGURE 15A.

**⚠ CAUTION**  
**TO PREVENT EXHAUSTING PRODUCTS FROM CIRCULATING TO THE AIR INTAKE IN**  
**WINDY/COLD AREAS, THE MAXIMUM PRACTICAL DISTANCE BETWEEN THESE TWO**  
**TERMINALS IS RECOMMENDED.**

## CANADIAN POWER VENT

**⚠ WARNING**  
**VENT HOOD(S) MAY BE**  
**EXTREMELY HOT**  
**DURING OPERATION.**

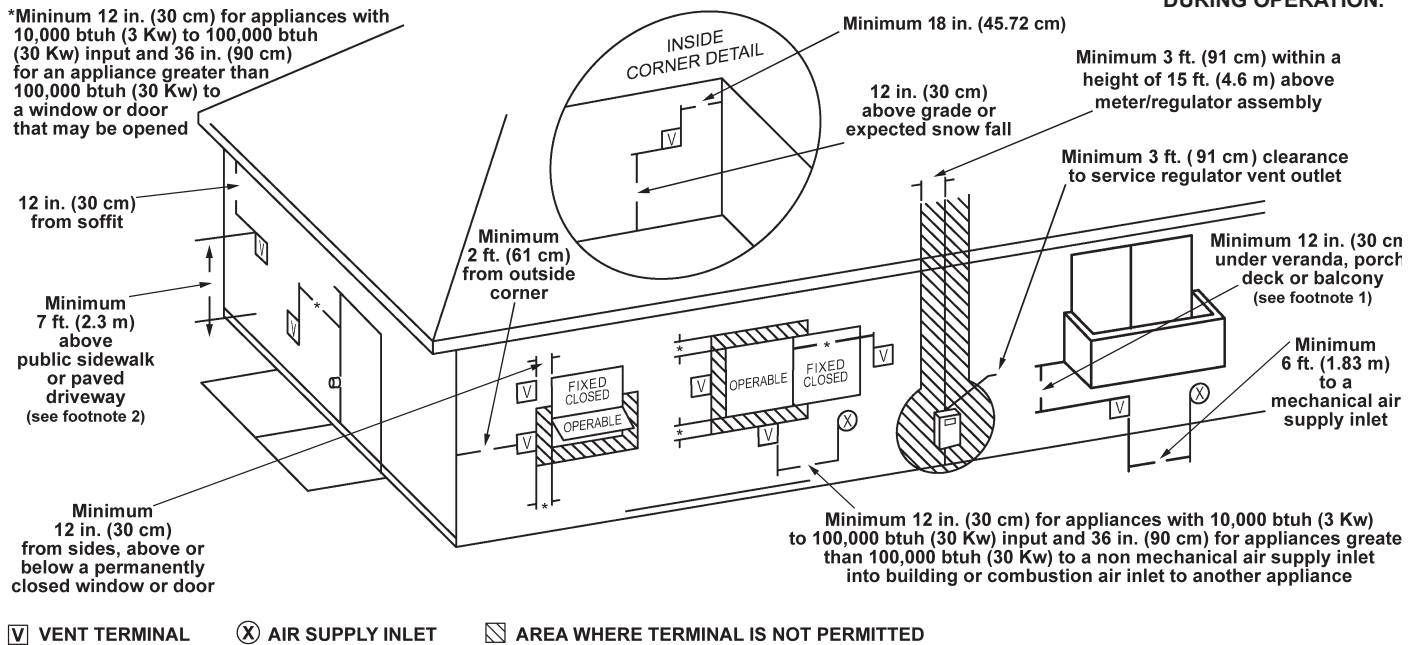

1. Permitted only if veranda, porch, deck or balcony is fully opened on a minimum of two sides beneath the floor.
2. A vent shall not terminate above a sidewalk or paved driveway that is located between two single family dwellings and serves both dwellings.

FIGURE 15B.

## U.S. DIRECT VENT

**⚠ WARNING**  
VENT HOOD(S) MAY BE  
EXTREMELY HOT  
DURING OPERATION.

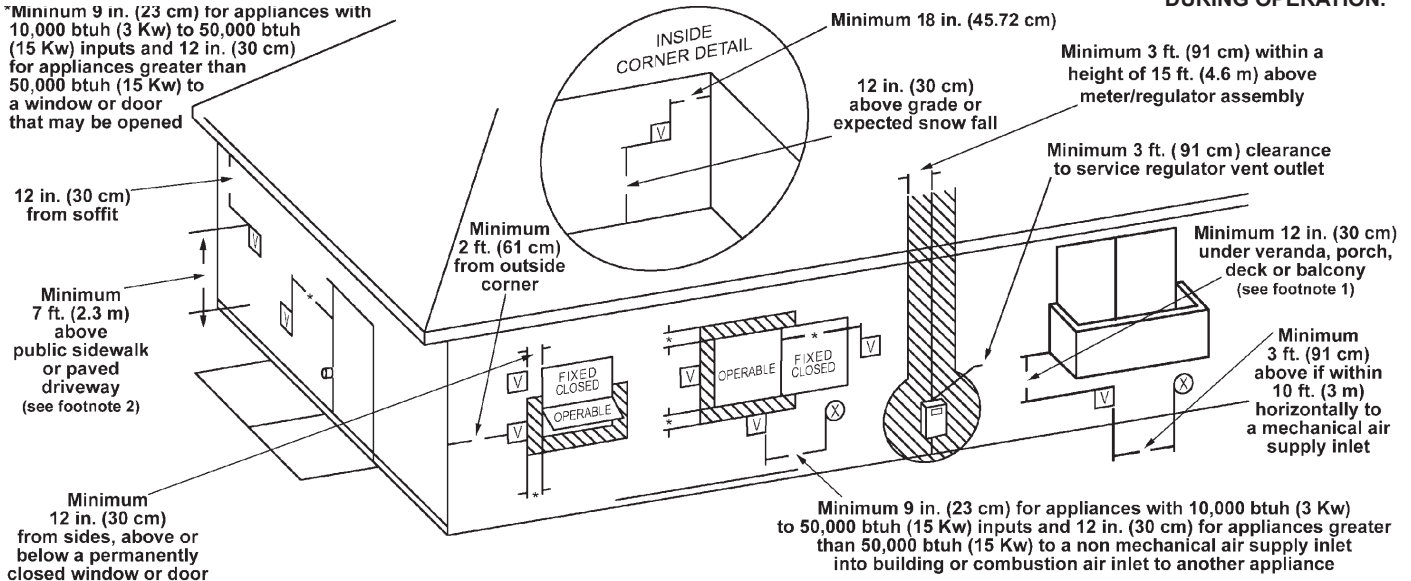

V VENT TERMINAL    
 X AIR SUPPLY INLET    
 / AREA WHERE TERMINAL IS NOT PERMITTED

1. Permitted only if veranda, porch, deck or balcony is fully opened on a minimum of two sides beneath the floor.
2. A vent shall not terminate above a sidewalk or paved driveway that is located between two single family dwellings and serves both dwellings.

FIGURE 15C.

**⚠ CAUTION**  
TO PREVENT EXHAUSTING PRODUCTS FROM CIRCULATING TO THE AIR INTAKE IN WINDY/COLD AREAS, THE MAXIMUM PRACTICAL DISTANCE BETWEEN THESE TWO TERMINALS IS RECOMMENDED.

## CANADIAN DIRECT VENT

**⚠ WARNING**  
VENT HOOD(S) MAY BE  
EXTREMELY HOT  
DURING OPERATION.

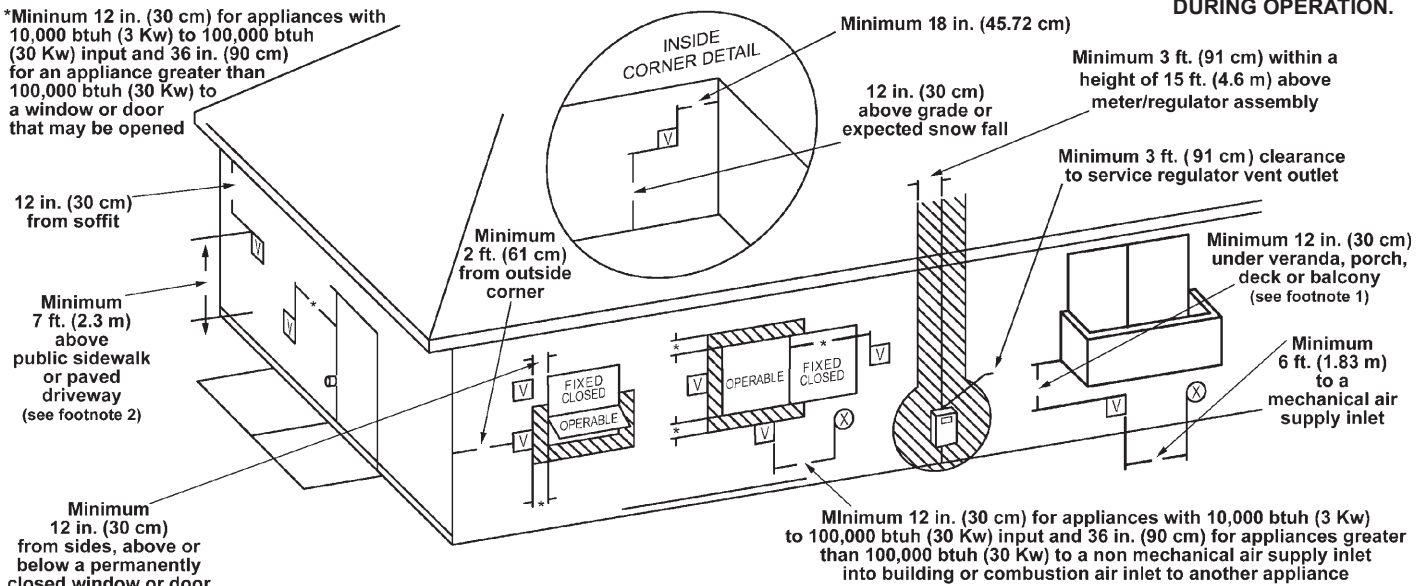

V VENT TERMINAL    
 X AIR SUPPLY INLET    
 / AREA WHERE TERMINAL IS NOT PERMITTED

1. Permitted only if veranda, porch, deck or balcony is fully opened on a minimum of two sides beneath the floor.
2. A vent shall not terminate above a sidewalk or paved driveway that is located between two single family dwellings and serves both dwellings.

FIGURE 15D.

## PLANNING THE VENT SYSTEM

Plan the route of the vent system from the exhaust elbow to the planned location of the vent terminal.

1. Layout total vent system to use a minimum of vent pipe and elbows.
2. This water heater is capable of venting flue gases equivalent to 25' (7.6 m) of 2" pipe, 65' (19.8 m) of 3" pipe, or 128' (39.0 m) of 4" pipe as listed in Table 1.

TABLE 1

Number of 90° Elbows	2" Maximum Pipe - ft. (m)	3" Maximum Pipe - ft. (m)	4" Maximum Pipe - ft. (m)
1	20 (6.1)	60 (18.3)	120 (36.6)
2	15 (4.6)	55 (16.8)	112 (34.1)
3	10 (3.0)	50 (15.2)	104 (31.7)
4	--	45 (13.7)	96 (29.3)
5	--	40 (12.2)	88 (26.8)
6	--	35 (10.7)	80 (24.3)

The minimum vent lengths for each of the pipe sizes is one 90° plus 2' (61 cm) of straight pipe and the appropriate termination.

**NOTE:** The equivalent feet (m) of pipe listed above are exclusive of the termination. That is, the termination, with an installed screen, is assumed to be in the system and the remainder of the system must not exceed the lengths discussed above.

3. The exhaust elbow assembly is designed to accept only straight sections of 2" pipe. To start, a minimum of 2" (5.1cm) of 2" pipe must be inserted and glued to the exhaust elbow assembly if utilizing 3" or 4" vent pipe. Use the same method with the blower inlet if a direct vent configuration is utilized.

### If using 2" inch vent pipe:

A minimum of 2" (5.1cm) diameter vent pipe must be attached to the exhaust elbow assembly. The total system cannot exceed the lengths discussed above, where each elbow is equal to 5 equivalent feet (1.5m) of straight pipe.

### If using 3" or 4" inch vent pipe:

Two inches (5.1cm) of 2" pipe must be attached to the exhaust elbow assembly before adding a reducer to acquire the desired pipe diameter. An appropriately sized 45 degree elbow (supplied locally-a schedule 40 DWV) vent terminal must be obtained with an equivalent screen (supplied in vent kit). The total system cannot exceed the equivalent pipe lengths discussed above where each elbow is equal to 5 feet (1.5m) of straight pipe (3" vent pipe) or 8 feet (2.4m) of straight pipe (4" vent pipe).

### U.S. INSTALLATIONS:

**NOTE:** This unit can be vented with PVC pipe materials (Cellular Core ASTM-F891; DWV ASTM-D2665 or CSA B181.2; Schedule 40, 80, 120 ASTM-D1785 or CSA B137.3; or SDR Series ASTM-D2241 or CSA B137.3), CPVC pipe materials (CPVC41 ASTM-D2846 or CSA B137.6; Schedule 40, 80 ASTM-F441 or CSA B137.6; or SDR Series ASTM-F442), ABS pipe materials (Schedule 40 DWV ASTM-D2661 or CSA B181.1 or Schedule 40 DWV Cellular Core ASTM-F628). The fittings, other than the **TERMINATION** should be equivalent to PVC-DWV fittings meeting ASTM D-2665 (Use CPVC fittings, ASTM F-438 for CPVC pipe and ABS fittings, ASTM D-2661/3311 for ABS pipe). If CPVC or ABS pipe and fittings are used, then proper cement must be used for all joints, including joining the pipe to Termination (PVC Material). If local codes do not allow the use of the PVC termination when a material other than PVC is used for venting, then an equivalent fitting of that material may be substituted if the screen in the PVC terminal is removed and inserted into the new fitting.

**Canadian Installation of this water heater must comply with CAN/CSA B149.1 - Natural Gas and Propane Installation Code which requires the vent system components be certified to ULC S636.**

This water heater has been design certified to be vented with PVC pipe certified and marked as complying with ULC S636. This water heater is supplied with a 2 inch 22.5 degree termination elbow that is a special fitting that must be used with the appliance. Any **outlet** piping, fittings and glue used to vent this appliance that is not supplied by the manufacturer must comply with the ULC S636 requirements.

PVC Materials should use ASTM D-2564 Grade Cement; CPVC Materials should use ASTM F-493 Grade Cement and ABS Materials should use ASTM D-2235 Grade Cement.

If the water heater is being installed as a replacement for an existing power vented heater in pre-existing venting, a thorough inspection

of existing venting system must be performed prior to any installation work. Verify that correct material as detailed above has been used, and that the minimum or maximum vent lengths and terminal location as detailed in this manual have been met. Carefully inspect the entire venting system for any signs of cracks or fractures, particularly at joints between elbows and other fittings and straight runs of vent pipe. Check system for signs of sagging or other stresses in joints as a result of misalignment of any components in the system. If any of these conditions are found, they must be corrected in accordance with the venting instructions in this manual before completing installation and putting the water heater into service.

**NOTE: A.** For water heaters in locations with high ambient temperatures (above 100°F) it is recommended that CPVC or ABS pipe and fittings be used. **B.** A 22.5 degree elbow (2" vent pipe) or a 45 degree elbow (3" and 4" vent pipe) with an installed screen **VENT TERMINAL** must be used in all cases.

4. There will be some installations where condensate will be formed in the horizontal runs of the vent system. This condensate will run into the condensate elbow. The water heater is shipped with a condensate hose that attaches to the condensate elbow. No other tee or fitting is required.

## CONDENSATE

This water heater is a condensing unit and requires a drain to be located in close proximity to allow the condensate to drain safely. The condensate drains from the unit at the exhaust tee located at the bottom of the unit (see figure 16). Condensate from this water heater is mildly acidic. Please note that some local codes require that condensate is treated by using a pH neutralizing filter prior to disposal.

Caution must be used to ensure that the drain is free and clear of debris and will not allow backflow through the condensate hose. Consideration must be given to avoid freezing of the condensate lines which could result in excessive build up of condensate inside the water heater. Waterproof heat tape may be required to prevent freezing of the condensate lines. Please ensure that the outlet of the condensate drain does not create a slippery condition which could lead to personal injury.

# ⚠ WARNING

## Breathing Hazard - Carbon Monoxide Gas



- Form an approximately 8" diameter loop in the condensate hoses on top of the water heater to trap water and prevent the escape of combustion by-products.
- Do not elevate the condensate hose on the bottom of the water heater above the bracket attached to the side of the unit. This must be true for the entire length of the hose including the exit into an appropriate drain.
- Condensate lines must be free and clear of debris and must not allow back flow through the hose. The condensate lines must be able to flow freely to an appropriate drain.
- Do not allow condensate lines to become crimped closed.
- Analyze the entire vent system to make sure that condensate will not become trapped in a section of vent pipe and therefore reduce the open cross sectional area of the vent.

Breathing carbon monoxide can cause brain damage or death.  
Always read and understand instruction manual.

**CONDENSATION WARNING: THIS WATER HEATER IS A CONDENSING UNIT AND REQUIRES A DRAIN TO BE LOCATED IN CLOSE PROXIMITY TO ALLOW CONDENSATE TO DRAIN SAFELY. THE CONDENSATE DRAINS FROM UNIT AT THE EXHAUST ELBOW LOCATED AT BOTTOM OF UNIT. NOTE: IT IS IMPORTANT THAT THE CONDENSATE HOSE NOT BE ELEVATED ABOVE THE EXHAUST ELBOW, SEE FIGURE 16. CONDENSATE BUILD-UP WILL BLOCK THE EXHAUST OUTLET, WHICH WILL CAUSE IMPROPER OPERATION.**

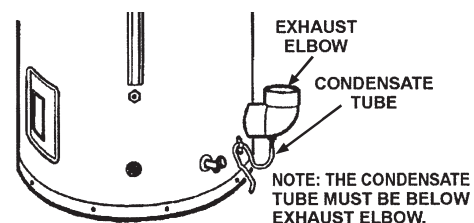

FIGURE 16.

## INSTALLATION OF VENT SYSTEM

Before beginning installation of piping system thoroughly read the section of this manual VENT PIPE PREPARATION.

If you are installing your system so that it vents through roof, please refer to section titled INSTALLATION OF VERTICAL VENT SYSTEM.

### VENT TERMINAL INSTALLATION, SIDEWALL

1. Install the vent terminal by using the cover plate as a template to mark the hole for the vent pipe to pass through the wall. BEWARE OF CONCEALED WIRING AND PIPING INSIDE THE WALL.
2. If the Vent Terminal is being installed on the outside of a finished wall, it may be easier to mark both the inside and outside wall. Align the holes by drilling a hole through the center of the template from the inside through to the outside. The template can now be positioned on the outside wall using the drilled hole as a centering point for the template.
3. A) MASONRY SIDE WALLS  
Chisel an opening approximately one half inch (1.3 cm) larger than the marked circle.  
  
B) WOODEN SIDE WALLS  
Drill a pilot hole approximately one quarter inch (0.64 cm) outside of the marked circle. This pilot hole is used as a starting point for a saws-all or sabre saw blade. Cut around the marked circle staying approximately one quarter inch (0.64 cm) outside of the line. (This will allow the vent to easily slide through the opening. The resulting gap will be covered up by the Vent Terminal cover plate.) Repeat this step on inside wall if necessary.

### SEQUENCE OF INSTALLATIONS, FIGURE 17

Cut a length of PVC pipe about 3.5 inches (8.9 cm) longer than the wall thickness at the opening. Glue the vent terminal to this section of pipe. Slide the wall plate over the pipe to stop against the vent terminal. Place a bead of caulking (not supplied) around the gap between the pipe and cover plate. Apply enough to fill some of the gap between the pipe and wall. Place some of the caulking on the back of the plate to hold it against the wall after installation. If the vent pipe is installed up to the wall, with a coupling on the end against the wall opening, the pipe with the vent terminal can be prepared for gluing before inserting through the wall. Slide the pipe through the wall and insert into the coupling on the other side of the wall, making sure that the vent terminal ends up pointed in the correct position, see Figure 17.

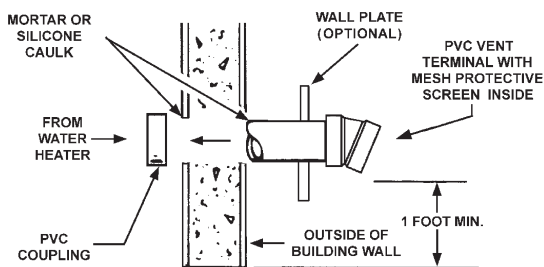

VENT TERMINATION - FIGURE 17.

## DIRECT VENTING

The air intake provided on the unit contains a mesh screen to prevent large particles from entering the unit.

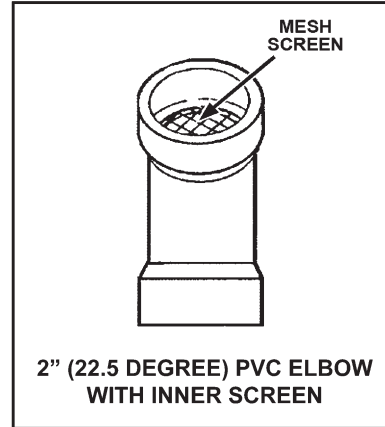

FIGURE 18A.

WHEN THE UNIT IS TO BE SETUP AS A DIRECT VENT, THE MESH SCREEN MUST BE REMOVED. THE INLET VENT PIPE MAY THEN BE GLUED TO THE AIR INTAKE (See Figure 18A) PROVIDED ON THE UNIT. THE SCREEN REMOVED FROM THE INTAKE NEEDS TO BE INSERTED INTO THE 2" - 22.5 DEGREE VENT TERMINAL SUPPLIED IN THE VENT TERMINAL KIT.

### DIRECT VENT TERMINAL INSTALLATION IMPORTANT

THIS UNIT CONSISTS OF TWO VENT TERMINALS - AN INTAKE VENT TERMINAL AND AN EXHAUST VENT TERMINAL. THE INTAKE VENT TERMINAL IS A 2" 22.5° PVC ELBOW(-) WITH A MESH WIRE SCREEN AND THE EXHAUST VENT TERMINAL IS A 2" 22.5° PVC ELBOW WITH A MESH WIRE SCREEN.

NOTE: TO PREVENT EXHAUSTING PRODUCTS FROM CIRCULATING TO THE AIR INTAKE IN WINDY/COLD AREAS, THE MAXIMUM PRACTICAL DISTANCE BETWEEN THESE TWO TERMINALS IS RECOMMENDED.

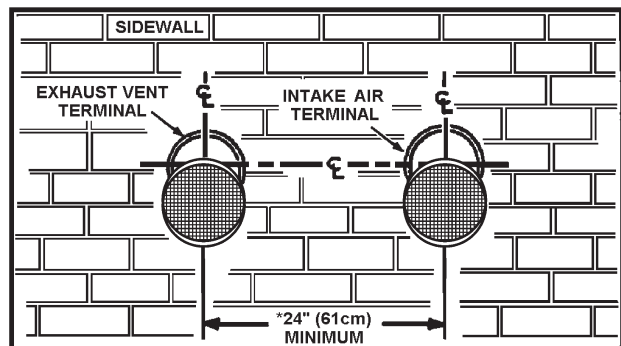

FIGURE 18B.

WHEN LOCATING THE TERMINALS ON A SIDEWALL, THE FOLLOWING SPECIFICATIONS PERTAINING TO TERMINAL LOCATION MUST BE FOLLOWED.

1. The intake air terminal and the exhaust vent terminal must terminate on the same exterior wall and must be separated by a minimum of 24" (61cm) on vertical centerline (see Figure 18B). In colder climates increasing the 24" (61cm) minimum will reduce possibility of frost over from side winds blowing exhaust vapors to the air intake of the direct vent.
2. The horizontal centerline of the intake air terminal may not be located lower than the horizontal centerline of the exhaust vent terminal (see Figure 18B).

## INSTALLATION SEQUENCE

For installations in the City of Los Angeles, California Category IV PVC Pipe such as that manufactured by Brownline Pipe Company, must be used as vent pipe material.

### ⚠ CAUTION

**VENT TERMINALS SUPPLIED WITH HEATER MUST BE USED.**

NOTE: BEFORE BEGINNING INSTALLATION OF ANY VENT PIPE READ THE VENT PIPE MANUFACTURER'S INSTALLATION INSTRUCTIONS.

- After the points of termination have been determined, use the cover plates as templates to mark the holes for the vent pipes to be inserted through the wall. BEWARE OF CONCEALED WIRING AND PIPING INSIDE OF WALL. If the vent terminals are being installed on the outside of a finished wall, it may be easier to mark both the inside and outside wall. Align the holes by drilling a hole through the center of the template from the inside through to the outside. The template can now be positioned on the outside wall using the drilled holes as a centering point for the template.

- MASONRY SIDE WALLS** Chisel an opening approximately 1/2" (1.3 cm) larger than the marked circle.
- WOODEN SIDE WALLS** Drill a pilot hole approximately one quarter inch outside of the marked circle. This pilot hole is used as a starting point for a saws-all or sabre saw blade. Cut around the marked circle staying approximately one quarter inch outside of the line. (This will allow the vent pipe to easily slide through the opening. The resulting gap will be covered by the vent terminal cover plates.) Repeat this step on the inside wall if necessary.

- Cut a length of 3" PVC pipe about 3.5" (8.9 cm) longer than the wall thickness at the opening.
- Glue the intake vent terminal to the section of the pipe.
- Slide the wall plate over pipe to stop against intake vent terminal.
- Place a bead of caulking (not supplied) around the gap between the pipe and the wall. Place some of the caulking on the back of the plate to hold it against the wall after installation.
- If the vent pipe is installed up to the wall, with a coupling on the end against the wall opening, the pipe with the vent terminal can be prepared for gluing before inserting through the wall. Slide the pipe through the wall and insert into coupling on the other side of the wall, making sure that the vent terminal ends up pointed in the correct position (Figure 19).

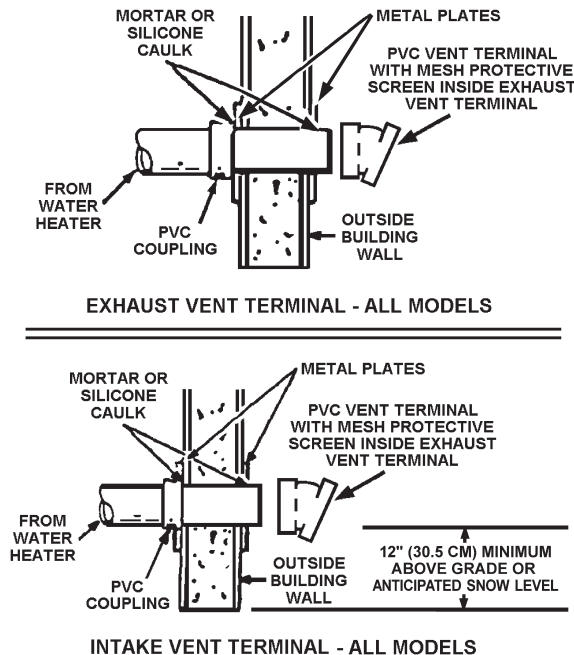

FIGURE 19.

## VERTICAL VENT TERMINAL INSTALLATION

### ⚠ IMPORTANT

**WHEN TERMINATING THROUGH A ROOF, THE FOLLOWING SPECIFICATIONS PERTAINING TO TERMINAL LOCATION MUST BE FOLLOWED.**

- Proper support must be provided for all pipe protruding through the roof.
- The vertical roof terminations should be sealed with a plumbing roof boot or equivalent flashing.
- The intake vent termination and the exhaust vent termination must penetrate the same side of roof.
- The center line of the intake vent termination and the center line of the exhaust vent termination must be no closer than 24" (61cm).
- The intake vent terminal and the exhaust vent terminal must be oriented facing downward and the same direction.

The specifications are displayed in Figures 20 & 21.

NOTE: Exhaust vent terminal is installed using the same procedure.

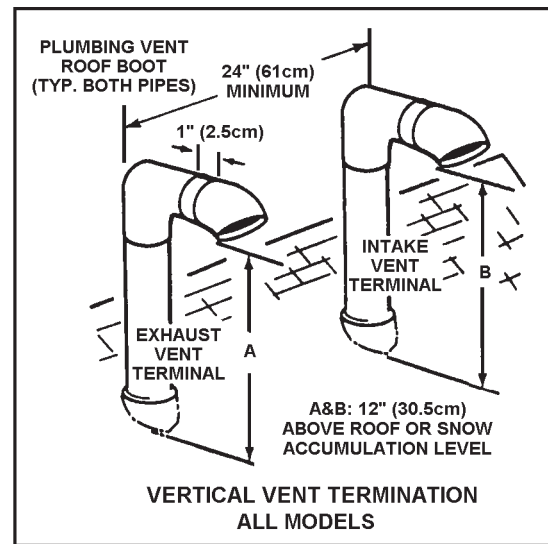

FIGURE 20.

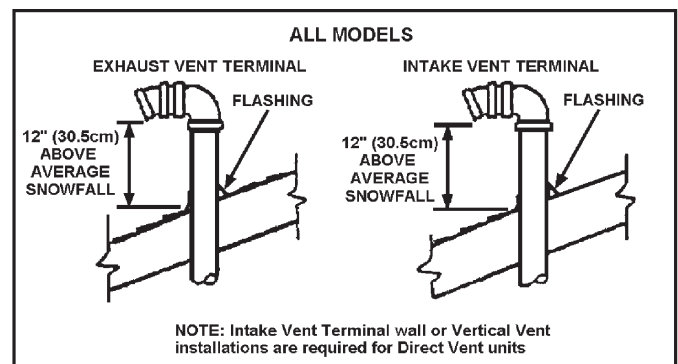

FIGURE 21.

## INSTALLATION OF VENT SYSTEM, SIDEWALL

With the route of the venting system and selection of materials completed, as discussed in the section of this manual titled PLANNING THE VENT SYSTEM, the through the wall vent terminal in place and the first section of piping, up to first elbow, installed at the blower it is time to complete the installation of the venting system for the sidewall installation.

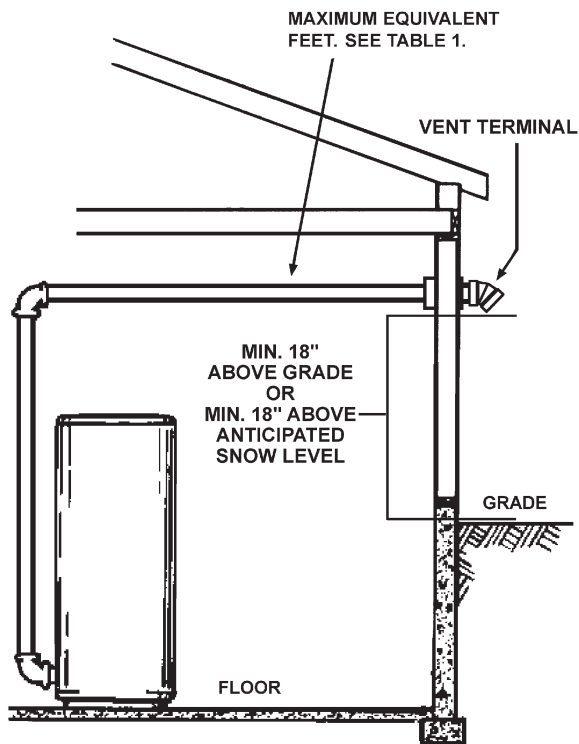

FIGURE 22.

Before completing the installation of the venting system be sure to read the sections of this manual discussing the proper method of cutting and cementing PVC pipe and fittings: VENT PIPE PREPARATION.

It is recommended that the completion of the venting system start at the blower assembly and run to the coupling on the inside wall of the vent terminal, Figure 18A.

The vent system piping should be supported every 5 feet (1.5 m) of vertical run and every 3 feet (91 cm) of horizontal run. All piping and fittings must be joined by the proper procedures as described under: VENT PIPE PREPARATION.

## INSTALLATION OF VERTICAL VENT SYSTEM

A proper flashing or "BOOT" should be used to seal the pipe where it exits the roof. The total vent system should not exceed the equivalent feet of pipe as listed in Table 1.

Provide support for all pipe protruding through the roof. All piping should be properly secured. The vent system piping should be supported every 5 feet (1.5 m) of vertical run and every 3 feet (91 cm) of horizontal run. All piping and fittings must be joined by the proper procedures as described under: VENT PIPE PREPARATION.

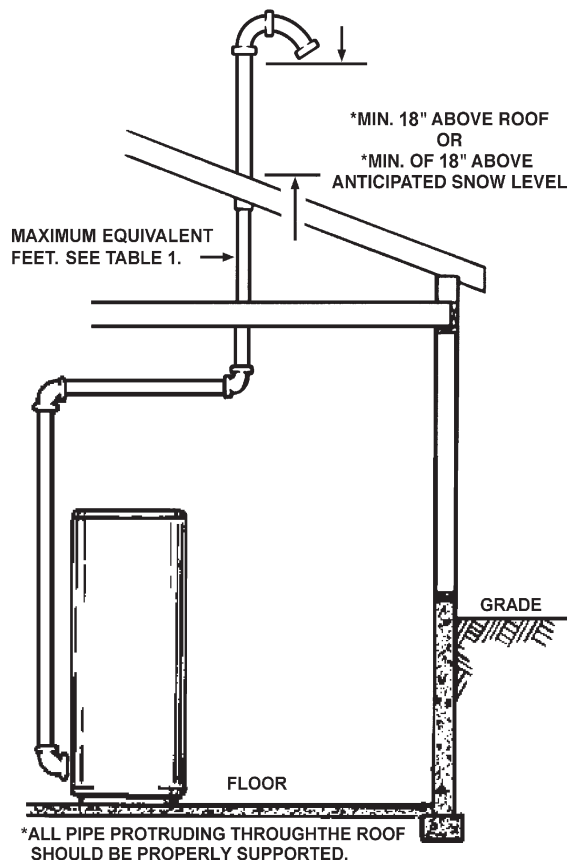

FIGURE 23.

### IMPORTANT

The vent system must terminate so that proper clearances are maintained as cited in local codes or the current edition of the National Fuel Gas Code (ANSI Z223.1) or the Natural Gas and Propane Installation Code (CAN/CSA-B149.1) and as listed below:

1. Vent Termination must extend a minimum of 18 inches (46 cm) above roof or 18 inches (46 cm) above the anticipated snow level to prevent blockage of the vent termination, as shown in Figures 20 and 21.

## CONCENTRIC VENT INSTALLATION

This appliance is certified for concentric venting with concentric vent kit #9003910105. Follow instructions below for proper installations.

### KIT COMPONENTS

Each kit is comprised of the following:

Item	Description	Qty.
Rain Cap	3 in.	1
SDR-26 pipe	4 in. dia.	1
SDR-26 pipe	2½ in. dia.	1
Y Concentric Fitting	3 in.	1
Installation Instructions	196149	1

Field supplied pipe and fittings are required to complete the installation.

This concentric vent termination kit may be used with 3 or 4 inch diameter pipe systems. When connecting to a 4 in. diameter pipe system a 3 x 4 inch field supplied reducer is to be installed at the intake and exhaust connection of the concentric vent termination kit.

### SAFETY CONSIDERATIONS

Installing and servicing water heating equipment can be hazardous due to gas and electrical components. Installation and service of the concentric vent termination requires ability equivalent to that of a qualified installer or service agent, see page 2. All precautions in the literature, on tags, and labels attached to the unit must be observed.

Follow all safety codes. Wear safety glasses and work gloves.

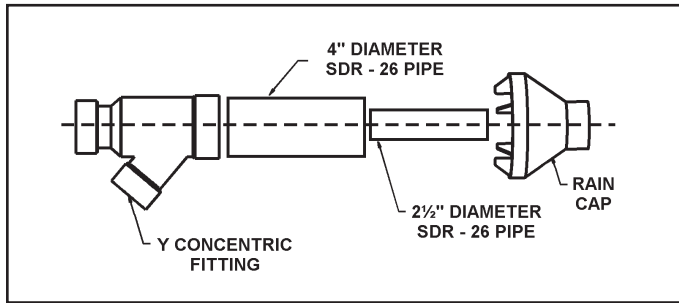

FIGURE A.

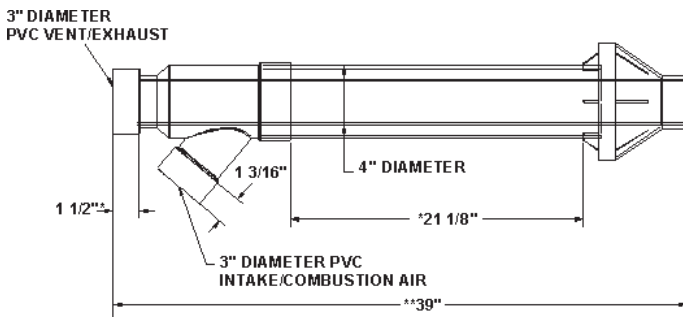

FIGURE B.

\* Dimension 21 1/8 in. may be lengthened to 60 in. maximum. Dimension 21 1/8 in. may also be shortened by cutting the pipes, provided in the kit, to 12 in. minimum.

\*\* Dimension 39 will change accordingly as dimension 21 1/8 in. is lengthened or shortened.

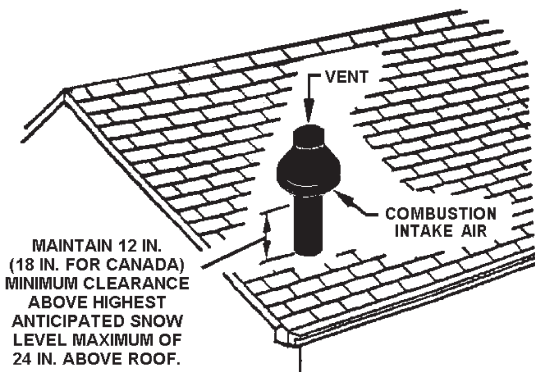

FIGURE C.

**INSTALLATION PROCEDURE 1 ROOF TERMINATION, see Figure C.**

1. Determine best location for termination kit.  
**NOTE: Roof termination is preferred since it is less susceptible to damage, has reduced chances to intake contaminants, and less visible vent vapors.**

2. Cut 1 hole (5 in. diameter)

3. Partially assemble concentric vent termination kit.

- a) Cement Y concentric fitting to larger diameter kit pipe, see Figure A.
- b) Cement rain cap to smaller diameter kit pipe, see Figure A.

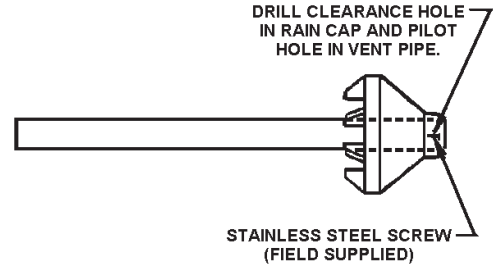

FIGURE D.

**NOTE: Instead of cementing the smaller pipe to the rain cap, a field-supplied stainless steel screw may be used to secure the 2 components together when field disassembly is desired for cleaning, see Figure D.**

### ⚠ WARNING

When using alternate screw method, drill clearance hole in rain cap and pilot hole in vent pipe for screw size being used. Failure to drill adequate holes may cause cracking of PVC components, allowing combustion products to be recirculated. Failure to follow this warning could result in personal injury or death.

### ⚠ WARNING

Do not operate the heater with rain cap removed or recirculation of combustion products may occur. Water may also collect inside larger combustion-air pipe and flow to the burner enclosure. Failure to follow this warning could result in product damage or improper operation, personal injury or death.

4. Install Y concentric fitting and pipe assembly through structure's hole and field supplied roof boot/flashing.

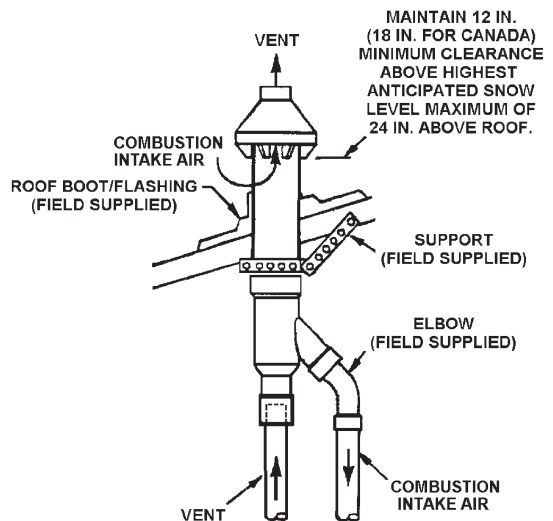

FIGURE E.

**NOTE: Do not allow insulation or other materials to accumulate inside pipe assembly when installing through hole.**

5. Secure assembly to roof structure as shown in Figure E using field supplied metal strapping or equivalent support material.

**NOTE: Ensure termination height is above the roof surface or anticipated snow level (1 ft. in U.S.A. or 1-1/2 ft. in Canada) as shown in Figure C.**

6. Install rain cap and small diameter pipe assembly in roof penetration assembly, Ensure small diameter pipe is cemented and bottomed in Y concentric fitting.

7. Cement water heater combustion air intake and vent pipes to concentric vent termination assembly. See Figure E for proper pipe attachment.

8. Operate heater through 1 heat cycle to ensure combustion air and vent pipes are properly connected to concentric vent termination connections.

**NOTE: All vent terminations must be the same height when installing multiple unit venting. If assembly is too short to meet height requirement, the 2 pipes supplied in the kit may be replaced by using same diameter, field supplied SDR-26 PVC (D2241) pipe. Do not extend the 21-1/8" dimension outer pipe to be more than 60 inches, see Figure B.**

**⚠ CAUTION**

Do not use field-supplied couplings to extend pipes. Airflow restriction will occur and the heater pressure switch may cause intermittent operation.

**PROCEDURE 2 SIDE WALL TERMINATION, see Figure F.**

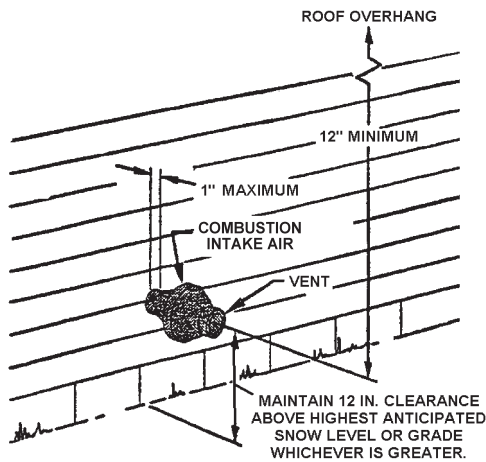

**FIGURE F.**

1. Determine best location for termination kit.

**NOTE:** Consideration for the following should be used when determining an appropriate location for the termination kit:

- Termination kit positioned where the vent vapors will not damage plants/shrubs or air conditioning equipment.
- Termination kit positioned so it will not be affected by wind eddy that may allow recirculation of combustion products, or airborne leaves, or light snow.
- Termination kit positioned where it will not get damaged or be subjected to foreign objects, such as stones, balls, etc.
- Termination kit positioned where the vent vapors will not be objectionable.

**NOTE: See the venting information (pages 16-20) in this manual for additional vent location requirements.**

2. Cut 1 hole (5 in. diameter)

3. Partially assemble concentric vent termination kit.

- a) Cement the Y concentric fitting to larger diameter kit pipe, see Figure A.
- b) Cement the rain cap to the smaller diameter kit pipe, see Figure A.

**NOTE: Instead of cementing the smaller pipe to the rain cap, a field-supplied stainless steel screw may be used to secure the 2 components together when field disassembly is desired for cleaning, see Figure D.**

**⚠ WARNING**

When using alternate screw assembly method, drill clearance hole in rain cap and pilot hole in vent pipe for screw being used. Failure to drill adequate holes may cause cracking of PVC components, allowing combustion products to be recirculated. Failure to follow this warning could result in personal injury or death.

**⚠ WARNING**

Do not operate the heater with rain cap removed or recirculation of combustion products may occur. Water may also collect inside larger combustion-air pipe and flow to the burner enclosure. Failure to follow this warning could result in product damage or improper operation, personal injury or death.

4. Install Y concentric fitting and pipe assembly through structure's hole.

**NOTE: Do not allow insulation or other materials to accumulate inside pipe assembly when installing through hole.**

5. Install rain cap and small diameter pipe assembly in Y concentric fitting and large pipe assembly. Ensure small diameter pipe is bottomed and cemented in Y concentric fitting.

6. Secure assembly to structure as shown in Figure G using field-supplied metal strapping or equivalent support material.

**NOTE: Ensure termination location clearance dimensions are as shown in the diagrams found in Figure 15 A through D. When extending the length of the 4" pipe, the added length beyond 21-1/8" must be deducted from the maximum equivalent feet of vent pipe.**

**NOTE: If assembly needs to be extended to allow side wall thickness requirement, the 2 pipes supplied in the kit may be replaced by using same diameter, field-supplied SDR-26 PVC (D2241) pipe. Do not extend 21 1/8" dimension more than 60 in. (See Figure B.)**

**⚠ CAUTION**

Do not use field-supplied couplings to extend pipes. Airflow restriction will occur and the heater pressure switch may cause intermittent operation.

7. Cement heater combustion-air and vent pipes to concentric vent termination assembly. See Figure G for proper pipe attachment.



- Operate heater through 1 heat cycle to ensure combustion-air and vent pipes are properly connected to concentric vent termination connections.

NOTE: SECURING STRAP MUST BE FIELD INSTALLED TO PREVENT MOVEMENT OF TERMINATION KIT IN SIDEWALL.

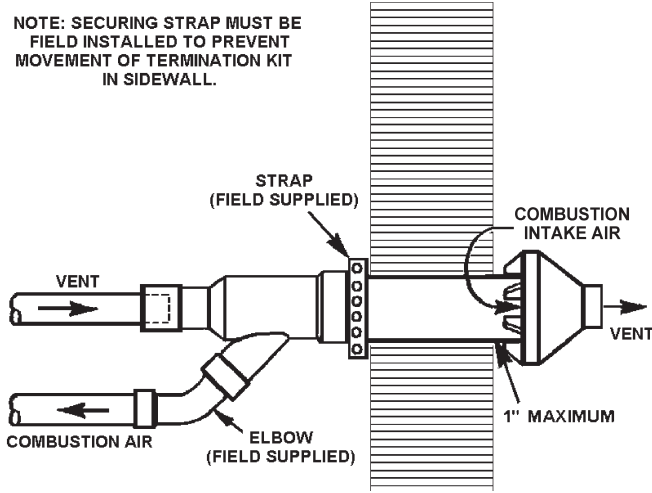

FIGURE G.

### MULTI-CONCENTRIC VENT TERMINATIONS

When two or more appliances are directed vented with concentric vent terminations near each other, each appliance must be individually vented. NEVER common vent this appliance. When two or more appliances are direct vented using concentric vent terminations, the appliances may be vented as shown in Figure H and Figure I.

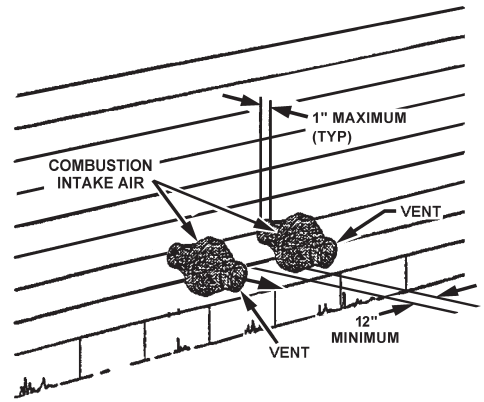

Figure H.  
Concentric Vent Terminations for Horizontal Direct Venting.

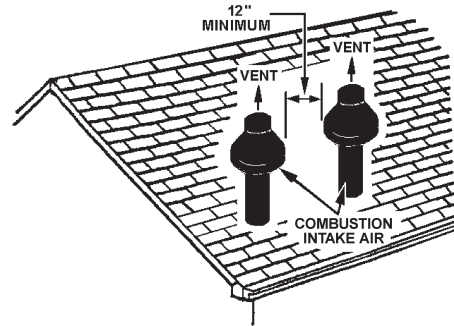

Figure I.  
Concentric Vent Terminations for Vertical Direct Venting through a roof.

## VENT PIPE PREPARATION

### 1. INITIAL PREPARATION.

- A.) Make sure the solvent cement you are planning to use is designed for the specific application you are attempting.
- B.) Know the physical and chemical characteristics and limitations of the PVC and CPVC piping materials that you are about to use.
- C.) Know the reputation of your manufacturer and their products.
- D.) Know your own qualifications or those of your contractor. The solvent welding technique of joining PVC and CPVC pipe is a specialized skill just as any other pipe fitting technique.
- E.) Closely supervise the installation and inspect the finished job before start-up.
- F.) Contact the manufacturer, supplier, or competent consulting agency if you have any questions about the application or installation of PVC and CPVC pipe.
- G.) Take the time and effort to do a professional job. Shortcuts will only cause you problems and delays in start-up. By far, the majority of failures in PVC and CPVC systems are the result of shortcuts and/or improper joining techniques.

### 2. SELECTION OF MATERIALS.

- Cutting Device - Saw or Pipe Cutter.
- Deburring Tool, Knife, File, or Beveling Machine (2" and above).
- Brush - Pure Bristle.
- Rag - Cotton (Not Synthetic).
- Primer and Cleaner.
- Solvent Cement - PVC for PVC Components and CPVC for CPVC Components.
- Containers - Metal or Glass to hold Primer and Cement. Select the type of PVC or CPVC materials to be used on the basis of their application with respect to chemical resistance, pressure rating, temperature characteristics, etc.
- Insertion Tool - Helpful for larger diameter pipe and fittings 6 inches (15.2cm) and above.

## ⚠ WARNING

### Fire or Explosion Hazard

- Do not store or use gasoline or other flammable vapors and liquids in the vicinity of this or any other appliance.
- Avoid all ignition sources if you smell LP gas.
- Do not expose water heater control to excessive gas pressure.
- Use only gas shown on rating plate.
- Maintain required clearances to combustibles.
- Keep ignition sources away from faucets after extended period of non-use.



Read instruction manual before installing, using or servicing water heater.



## PRIMER

It is recommended that Tetrahydrofuran (THF) be used to prepare the surfaces of pipe and fittings for solvent welding. Do not use water, rags, gasoline or any other substitutes for cleaning PVC or CPVC surfaces. A chemical cleaner such as MEK may be used.

## CEMENT

The cement should be a bodied cement of approximately 500 to 1600 centipoise viscosity containing 10-20% (by weight) virgin PVC material solvated with tetrahydrofuran (THF). Small quantities of dimethyl formamide (DMF) may be included to act as a retarding agent to extend curing time. Select the proper cement; Schedule 40 cement should be used for Schedule 40 pipe. Never use all-purpose cements, commercial glues and adhesives or ABS cement to join PVC or CPVC pipe and fittings.



## ⚠ WARNING

### Fire Hazard

- Primers and cements are extremely flammable, and must not be stored or used near heat or open flame.
- Also, use only in a well ventilated area.

## APPLICATORS

Select a suitable pure bristle type paint brush. Use a proper width brush or roller to apply the primer and cement (see chart below). Speedy application of cement is important due to its fast drying characteristics. IMPORTANT NOTE: A dauber type applicator should only be used on pipe sizes 2" and below. For larger diameter pipe, a brush or roller must be used.

RECOMMENDED BRUSH* SIZE FOR PRIMER AND CEMENT APPLICATIONS	
Nominal Pipe (IPS)	Size Brush Width
2	1.5" (3.8cm)
3	1.5"-2.5" (3.8cm - 6.4cm)

**\*USE ONLY NATURAL BRISTLE**

### 3. MAKING THE JOINT.

- A.) Cutting Pipe must be squarely cut to allow for the proper interfacing of the pipe end and the fitting socket bottom. This can be accomplished with a miter box saw or wheel type cutter. Wheel type cutters are not generally recommended for larger diameters since they tend to flare the corner of the pipe end. If this type of cutter is used, the flare on the end must be completely removed.

NOTE: Power saws should be specifically designed to cut plastic pipe.

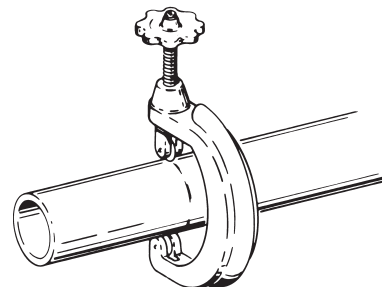

**STEP A**

## B. Deburring

Use a knife, plastic pipe deburring tool, or file to remove burrs from the end of small diameter pipe. Be sure to remove all burrs from around the inside as well as the outside of the pipe. A slight chamfer (bevel) of about 10°-15° should be added to the end to permit easier insertion of the pipe into the end of the fitting. Failure to chamfer the edge of the pipe may remove cement from the fitting socket, causing the joint to leak.

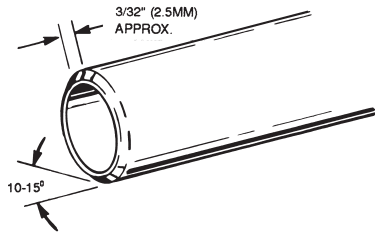

STEP B

## C. Test dry fit of the joint

Tapered fitting sockets are designed so that an interfaced fit should occur when the pipe is inserted about 1/3 to 2/3 of the way into the socket. Occasionally, when pipe fitting dimensions are at the tolerance extremes, it will be possible to fully insert dry pipe to the bottom of the fitting socket. When this happens, a sufficient quantity of cement must be applied to the joint to fill the gap between the pipe and fitting. The gap must be filled to obtain a strong, leak-free joint.

## D. Inspection, cleaning, priming

Visually inspect the inside of the pipe and fitting sockets and remove all dirt, grease or moisture with a clean dry rag. If wiping fails to clean the surfaces, a chemical cleaner must be used. Check for possible damage such as splits or cracks and replace if necessary.

### Depth-of-entry

Marking the depth of entry is a way to check if the pipe has reached the bottom of the fitting socket in Step F. Measure the fitting depth and mark this distance on the pipe O.D. You may want to add several inches to the distance and make a second mark as the primer and cement will most likely destroy your first one.

Apply primer to the surface of the pipe and fitting socket with a natural bristle brush. This process softens and prepares the PVC or CPVC for the solvent cementing step. Move quickly and without hesitation to the cementing procedure while the surfaces are still wet with primer.

## E. Application of solvent cement

- Apply the solvent cement evenly and quickly around the outside of the pipe at a width a little greater than the depth of the fitting socket.
- Apply a light coat of cement evenly around the inside of the fitting socket. Avoid puddling.
- Apply a second coat of cement to the pipe end.

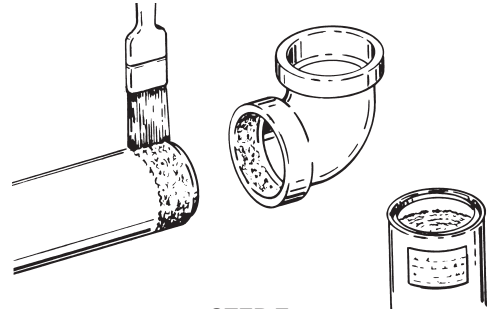
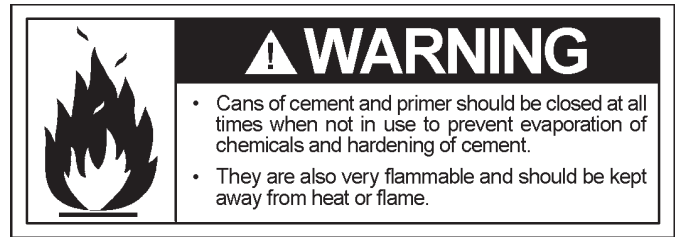

STEP E

## F. Joint assembly

Working quickly, insert the pipe into the fitting socket bottom and give the pipe or fitting a 1/4 turn to evenly distribute the cement. Do not continue to rotate the pipe after it has hit the bottom of the fitting socket. A good joint will have sufficient cement to make a bead all the way around the outside of the fitting hub. The fitting will have a tendency to slide back while the cement is still wet so hold the joint together for about 15 seconds.

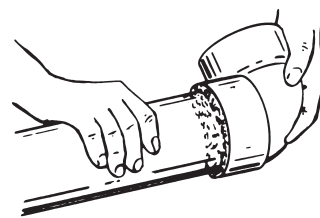

STEP F

## G. Cleanup and joint movement

Remove all excess cement from around the pipe and fitting with a dry cotton rag. This must be done while the cement is still soft.

The joint should not be disturbed immediately after the cementing procedure, and sufficient time should be allowed for proper curing of the joint. Exact drying time is difficult to predict because it depends on variables such as temperature, humidity and cement integrity. For more specific information, you should contact your solvent cement manufacturer.

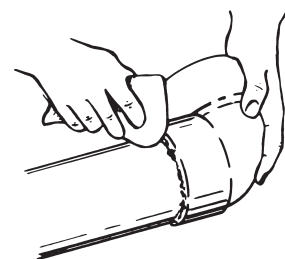

STEP G

## CONTROLS AND SWITCHES

This model is provided with three pressure switches. These switches are essential to the safe and proper operation of the unit. All switches are wired in series. The controller is set up to shut the unit down whenever there is a failure of any of the switches. It is important to understand the purpose of each switch.

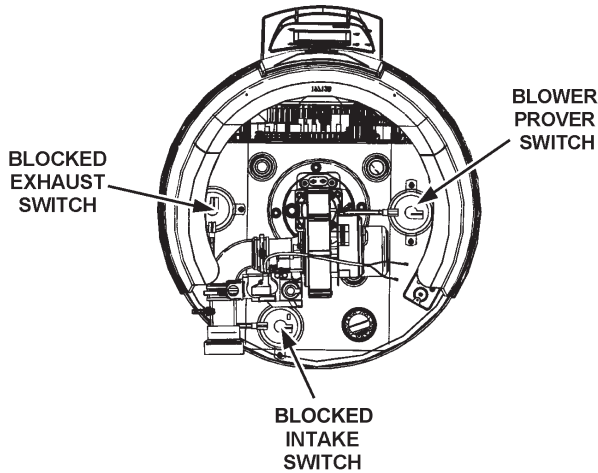

FIGURE J.

### BLOWER PROVER SWITCH

(SEE FIGURE J)

The Blower Prover Switch is provided on the heater to verify that the fan is operating. It is a positive pressure switch whose electrical contacts are normally open. When the fan increases the pressure in the burner, the pressure switch will allow the electrical contacts to close. The pressure switch is connected to the burner tap by a piece of tygon tubing. This tubing must be connected in order for the switch to change the electrical contacts. The controller requires that the electrical contacts on this air flow switch be open before it will allow the blower to come on.

### BLOCKED EXHAUST SWITCH

(SEE FIGURE J)

The Blocked Exhaust Switch is set up to shut the unit off when a build-up of positive pressure in the exhaust vent pipe occurs. This switch is a positive pressure switch that requires an increase in pressure to change the electrical contacts from normally closed to

open. When this switch prevents the unit from igniting, most likely the exhaust is blocked by some means. Check to see if the condensate is allowed to flow freely from the exhaust elbow and for obstructions in the exhaust venting and exhaust vent terminal. Also verify that the vent length does not exceed the maximum allowed as shown in the Vent Section of this manual.

### BLOCKED INTAKE SWITCH

(SEE FIGURE J)

The Blocked Intake Switch is set up to shut the unit off when a build-up of negative pressure in the intake air pipe occurs. This switch is a negative pressure switch that requires an increase in negative pressure to change the electrical contacts from normally closed to open. The switch is connected to the pressure tap on the PVC pipe connected to the inlet of the blower. When this switch prevents the unit from igniting, most likely the intake is blocked. Verify that the screen on the intake air connection (conventional vent), the intake air pipe and termination (direct vent installations) are free of obstructions that may prevent air from entering the unit. Insure the screen on intake air connection has been removed on direct vent installations, see Figure 18B. Also verify the intake air pipe length does not exceed the maximum allowed as shown in the Vent Section of this manual.

### ON/OFF SWITCH

The ON/OFF Switch is a single-pole, single-throw rocker switch. This switch provides 120V from the line source to the heater.



**THE WATER HEATER IS POLARITY SENSITIVE. BEFORE APPLYING ELECTRICITY TO THIS HEATER BE CERTAIN THAT SUPPLY NEUTRAL WIRE TO GROUND CHECK INDICATES ZERO VOLTAGE.**

### HOT SURFACE IGNITER

The Hot Surface Igniter is a device that ignites the main burner by high temperature (>1800°F or >982°C). When 120VAC is applied to the igniter, sufficient heat is generated to ignite the main burner. Although improvements have been made to strengthen the igniter, it is still fragile and care must be taken when handling the igniter to prevent breakage.



**CAUTION**  
 LABEL ALL WIRES PRIOR TO DISCONNECTION WHEN SERVICING CONTROLS. WIRING ERRORS CAN CAUSE IMPROPER AND DANGEROUS OPERATION. VERIFY PROPER OPERATION AFTER SERVICING.

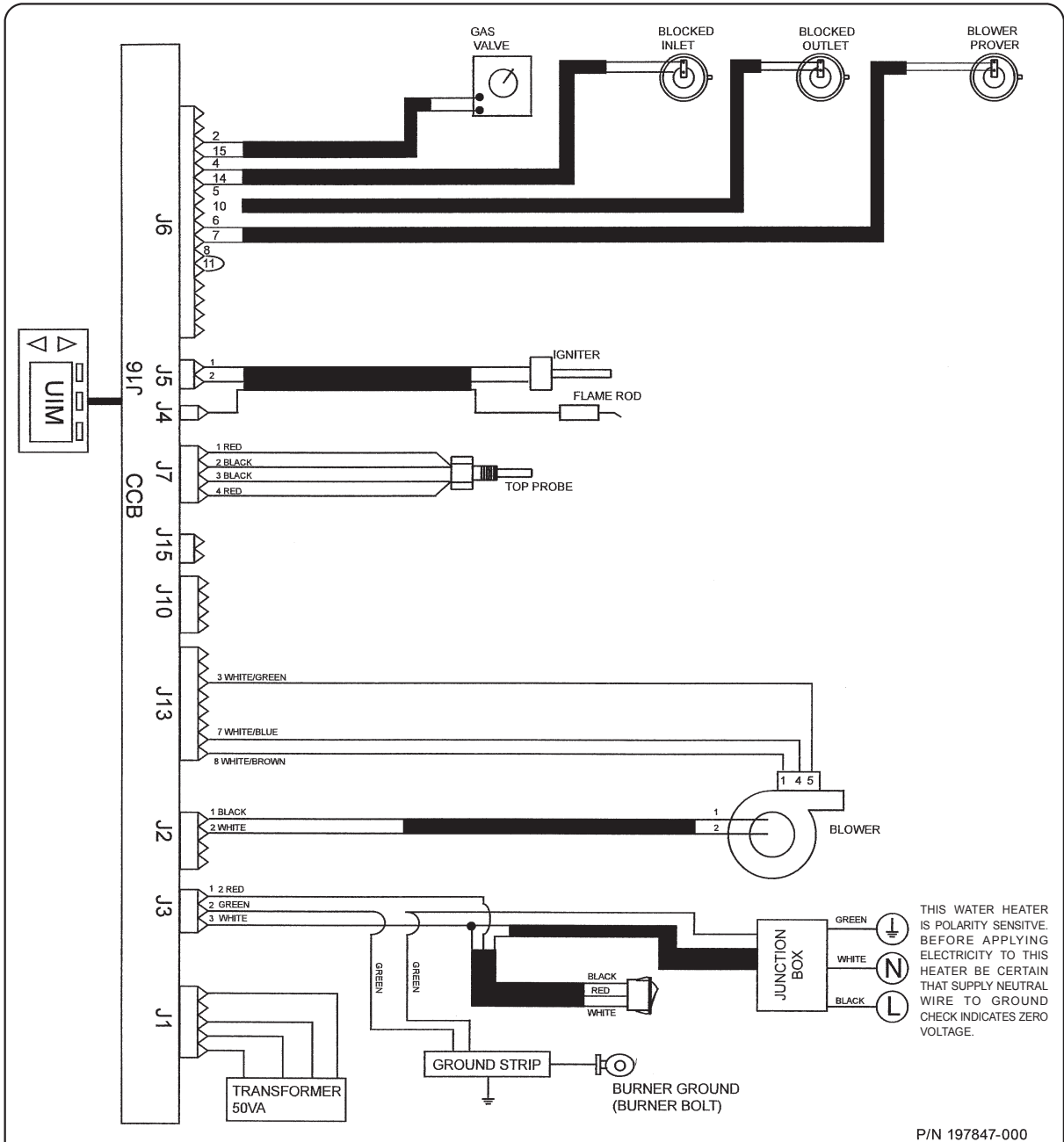

P/N 197847-000

**WARNING**

DISCONNECT FROM ELECTRICAL SUPPLY BEFORE SERVICING UNIT.  
 REPLACE ALL DOORS AND PANELS BEFORE OPERATING HEATER.

IF ANY OF THE ORIGINAL WIRES SUPPLIED WITH THE APPLIANCE MUST BE REPLACED, IT MUST BE REPLACED WITH APPLIANCE WIRE MATERIAL WITH MINIMUM TEMPERATURE RATING OF 105°C AND A MINIMUM SIZE OF NO. 18 AWG.

**POWER VENT WIRING SCHEMATIC - FIGURE 24.**

## FOR YOUR SAFETY READ BEFORE LIGHTING



**WARNING:** If you do not follow these instructions exactly, a fire or explosion may result causing property damage, personal injury or loss of life.



**BEFORE OPERATING: ENTIRE SYSTEM MUST BE FILLED WITH WATER AND AIR PURGED FROM ALL LINES.**

- A. This appliance does not have a pilot. It is equipped with an ignition device which automatically lights the burner. **Do NOT try to light the burner by hand.**
- B. **BEFORE OPERATING** smell all around the appliance area for gas. Be sure to smell next to the floor because some gas is heavier than air and will settle on the floor.
- WHAT TO DO IF YOU SMELL GAS:**
- Do not try to light any appliance.
  - Do not touch any electric switch; Do not use any phone in your building.
  - Immediately call your gas supplier from a neighbor's phone. Follow the gas supplier's instructions.
  - If you cannot reach your gas supplier, call the fire department.
- C. Use only your hand to push in the gas control buttons. Never use tools. If the control buttons will not push in, don't try to repair them, call a qualified service technician. Force or attempted repair may result in a fire or explosion.
- D. Do not use this appliance if any part has been under water. Immediately contact a qualified installer or service agency to replace a flooded water heater. Do not attempt to repair the unit! It must be replaced!

## OPERATING INSTRUCTIONS

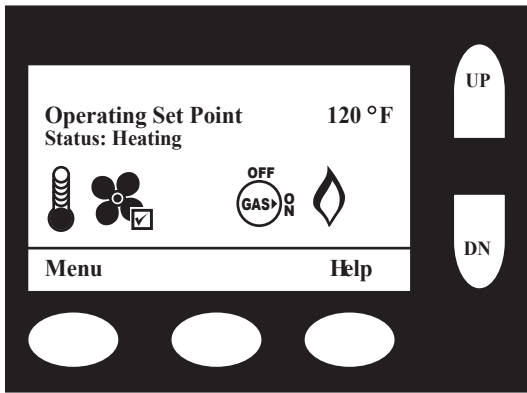

ON/OFF SWITCH

1. STOP! Read the safety information above, on this label.
2. Set the ON/OFF switch on the control panel to the "ON" position.
3. Set the thermostat to the lowest setting.
4. Set the ON/OFF switch on the control box to the "OFF" position.
5. This appliance is equipped with a device which automatically lights the burner.  
**DO NOT TRY TO LIGHT THE BURNER BY HAND.**
6. Wait five (5) minutes to clear out any gas. If you smell gas, STOP! Follow "B" in the safety information above on this label. If you don't smell gas.
7. Turn on all electrical power to the appliance.
8. Set the ON/OFF switch on the control box to the "ON" position.
9. Set the thermostat to the desired setting.  
 **CAUTION: Hotter water increases the risk of scald injury. Consult the instruction manual before changing temperature.**
10. If the appliance will not operate, follow the instructions "TO TURN OFF GAS TO APPLIANCE" and call your technician or gas supplier.  
 **WARNING: TURN OFF ALL ELECTRIC POWER BEFORE SERVICING**

## TO TURN OFF GAS TO APPLIANCE

1. Set the thermostat to the lowest setting.
2. Set the ON/OFF switch on the control panel to the "OFF" position.
3. Turn off all electrical power to the appliance if service is to be performed.

# TEMPERATURE REGULATION

It is recommended that lower water temperatures be used to avoid the risk of scalding. It is further recommended, in all cases, that the water temperatures be set for the lowest temperature which satisfies your hot water needs. This will also provide the most energy efficient operation of the water heater.

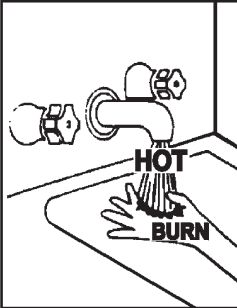

**⚠ DANGER** Water temperature over 125°F (52°C) can cause severe burns instantly resulting in severe injury or death.

Children, the elderly, and the physically or mentally disabled are at highest risk for scald injury.

Feel water before bathing or showering.

Temperature limiting valves are available.

Read instruction manual for safe temperature setting.

**HOT WATER CAN SCALD:** Water heaters are intended to produce hot water. Water heated to a temperature which will satisfy space heating, clothes washing, dish washing, and other sanitizing needs can scald and permanently injure you upon contact. Some people are more likely to be permanently injured by hot water than others. These include the elderly, children, the infirm, or physically/mentally handicapped. If anyone using hot water from this heater fits into one of these groups or if there is a local code or state law requiring a certain temperature water at the hot water tap, then you must take special precautions. In addition to using the lowest possible temperature setting that satisfies your hot water needs, a means such as a mixing valve, should be used at the hot water taps used by these people or at the water heater. Mixing valves are available at plumbing supply or hardware stores, see Figure 2. Follow manufacturer's instructions for installation of the valves. Before changing the factory setting on the thermostat, read the "Temperature Regulation" section in this manual.

Never allow small children to use a hot water tap, or to draw their own bath water. Never leave a child or handicapped person unattended in a bathtub or shower.

The water heater should be located in an area where the general public does not have access. If a suitable area is not available, a cover should be installed over the thermostat to prevent tampering. The water temperature setting was factory set at the lowest temperature; **THIS WATER HEATER IS EQUIPPED WITH AN ADJUSTABLE THERMOSTAT TO CONTROL WATER TEMPERATURE. HOT WATER TEMPERATURES REQUIRED FOR AUTOMATIC DISHWASHER AND LAUNDRY USE CAN CAUSE SCALD BURNS RESULTING IN SERIOUS PERSONAL INJURY AND/OR DEATH. THE TEMPERATURE AT WHICH INJURY OCCURS VARIES WITH THE PERSON'S AGE AND THE TIME OF THE EXPOSURE. THE SLOWER RESPONSE TIME OF CHILDREN, AGED OR DISABLED PERSONS INCREASES THE HAZARDS TO THEM. NEVER ALLOW SMALL CHILDREN TO USE A HOT WATER TAP, OR TO DRAW THEIR OWN BATH WATER. NEVER LEAVE A CHILD OR DISABLED PERSON UNATTENDED IN A BATHTUB OR SHOWER.**

**THE WATER HEATER SHOULD BE LOCATED IN AN AREA WHERE THE GENERAL PUBLIC DOES NOT HAVE ACCESS TO SET TEMPERATURES.**

**SETTING THE WATER HEATER TEMPERATURE AT 120°F/49°C WILL REDUCE THE RISK OF SCALDS.** Some states require settings at specific lower temperatures.

The water temperature is controlled using the Temperature Control on the Display at the front of the unit (See Figure 1). This control utilizes a temperature probe to determine the tank temperature. The primary temperature probe is located at the top of the tank.

The temperature may be adjusted from 90°F/32°C to 160°F/71°C. The thermostat was adjusted to 120°F/49°C before the heater was shipped from the factory. It is recommended that lower water temperature be used to avoid the risk of scalding. It is further recommended, in all cases, that the water temperature be set for the lowest temperature which satisfies your hot water needs. This will also provide the most energy efficient operation of the water heater and minimize scale formation.

Valves for reducing the point-of-use temperature by mixing cold and hot water are available, see Figure 2. Also available are inexpensive devices that attach to faucets to limit hot water temperatures. Contact a licensed plumber or the local plumbing authority.

The table below shows the approximate time-to-burn relationship for normal adult skin. Short repeated heating cycles caused by small hot water uses can cause temperatures at the point of use to exceed the thermostat setting by up to 20°F/11°C. If you experience this type of use, you should consider using lower temperature settings to reduce scald hazards.

Temperature Setting	Time to Produce 2nd & 3rd Degree Burns on Adult Skin
160°F (71°C)	About 1/2 Second
150°F (65°C)	About 1 1/2 Seconds
140°F (60°C)	Less than 5 Seconds
130°F (54°C)	More than 30 Seconds
120°F (49°C)	More than 5 minutes

## HI LIMIT SWITCH (E.C.O.)

The top immersion well of the dual bulb controller also contains the high limit (energy cutoff) sensor. The high limit switch interrupts main burner gas flow should water temperature reach approximately 202°F/94°C.

Should the high limit switch activate, the control system will automatically reset the unit once the water temperature in the tank falls below 140°F/60°C. If the unit is manually shut down and restarted, as long as the temperature in the tank is lower than 160°F/71°C, the unit will reset and initiate operation.

If you experience higher than usual water temperature along with frequent automatic resetting of the system, this is evidence of high limit switch operation. The following are possible reasons for high limit switch operation.

- A malfunction in the thermostatic controls would allow the gas control valve thermostat to remain open causing water temperature to exceed the thermostat setting. The water temperature would continue to rise until high limit switch operation.

Contact your dealer or servicer if continued high limit switch operation occurs.

## USING THE ELECTRONIC CONTROLLER

### 1. Overview

Interaction with the water heater controller is done through an up, a down, and three operation buttons. These buttons are illustrated to the right. Operation of the three lower buttons is defined immediately above them on the screen. The [UP] and [DN] buttons are used to navigate through the menus and make adjustments to the water heater.

While the water heater is operating, the user interface will display the desktop screen (if there are no active faults or warnings). An example of this screen is shown to the right. The temperature on this screen is the Operating Set Point. The Operating Set Point is the temperature at which the water heater will maintain the water inside the tank. The second line on the screen is a text description of the Operational State of the water heater (please see Operating States for more details).

The following status icons describe graphically operational details of the heater. The legend of all the status icons is listed below.

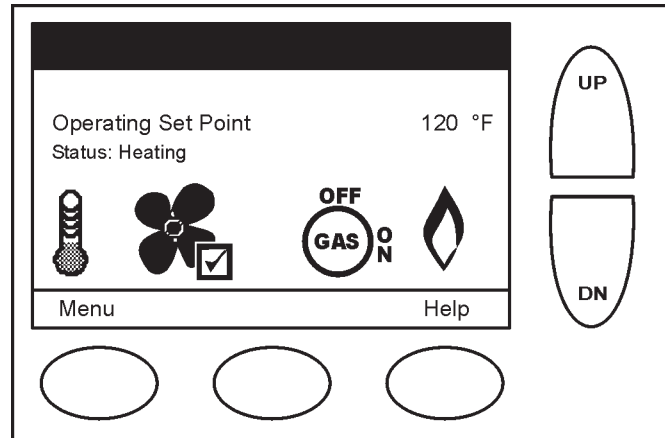

STAUS ICON	DESCRIPTION
	The temperature of the water in the tank has fallen and the water heater will now initialize a new heating cycle.
	The temperature of the water in the tank has reached the <i>Operating Set Point</i> .
	The control is unable to initiate any further heating cycles. This is usually caused by a fault condition detected by the control, but can also occur when an external system (like an energy management system) has asked the water heater to discontinue any further heat cycles.
	The blower is being energized.
	The blower pressure switch has been made.

STAUS ICON	DESCRIPTION
	The igniter has been energized
	The igniter has been energized and sufficient current for ignition has been detected.
	The control has requested that the gas valve be turned on.
	The control has sensed flame in the burner
	The control has detected a fault condition
	The control has detected a warning condition. These conditions will not cause the water heater to discontinue further heating cycles, but does merit attention.



## 2. Operating States

In the main desktop screen, there are some specific Operating States that are indicated on the status line. These are summarized below:

STATE	DESCRIPTION
Standby	The water heater is not in an active heating cycle. Usually this means the temperature in the tank has reached a sufficient temperature and has not dropped low enough to initiate a call for heat.
Input Verification	The electronic controls are waiting for specific conditions to occur (primarily pressure switch states) before the unit can continue to heat water.
Short Cycle Delay	The electronic controls are waiting a defined period of time before initiating another call for heat just after the last on has ended. This prevents the water heater from "Short Cycling."
Pre-Purge	The blower has been energized and excess gas in the heater exchanger is being flushed to start a new heating cycle.
Igniter Warmup	The igniter has been energized and is currently

STATE	DESCRIPTION
Ignition Activation	The controls are allowing for a steady flame to be established in the burner
Ignition Verification	Assurance of proper flame sense is being determined
Inter-Purge	After a failure to ignite the burner, the control is attempting to purge any excess gas from the heater exchanger before another attempt to light.
Heating	The water heater has been properly lit, and the water in the tank is being heated
Post-Purge	Excess gas is being pushed out of the heater exchanger after a successful heating cycle.
Fault	The water heater control has detected a fault. No further heating of the water will be done.

## 3. Adjusting the Operating Set Point

The *Operating Set Point* of this water heater determines the regulated temperature for the water in the tank. This parameter is adjusted in the Temperature menu. Items in this menu allow you to monitor different temperature readings in the tank along with adjusting the *Operating Set Point*.

### ACTION:

From the desktop screen, press **Menu**.

### DISPLAY:

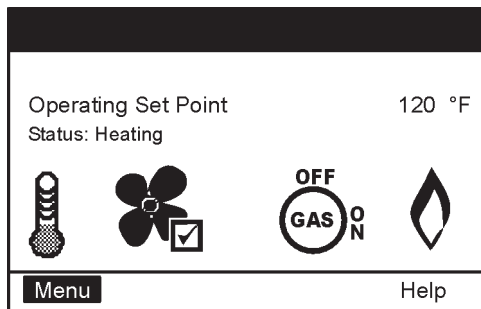

### ACTION:

From the Main Menu, press **Select** to enter the "Temperatures" screen.

### DISPLAY:

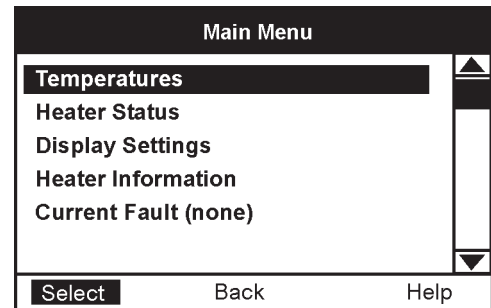

### ACTION:

Press **Change** then use the **UP** and **DOWN** buttons to change the Set Point.

### 3. Changing the Display Units

The display interface to the heater has the option of selecting between degrees Fahrenheit and degrees Celsius for temperature displays. This can be found in the "Display Settings" menu. Also in this menu, you may adjust how the backlight operates and the contrast of the LCD screen.

**ACTION:**

From the Main Menu, press the Down button to highlight "Display Settings" then press Select.

**DISPLAY:**

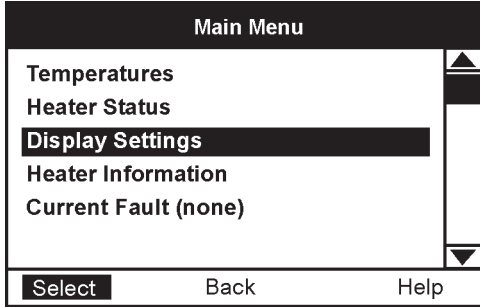

**ACTION:**

Use the UP and DOWN buttons to highlight the desired setting. Then press Change. Again, use the UP and DOWN buttons to scroll through the options for that setting.

**DISPLAY:**

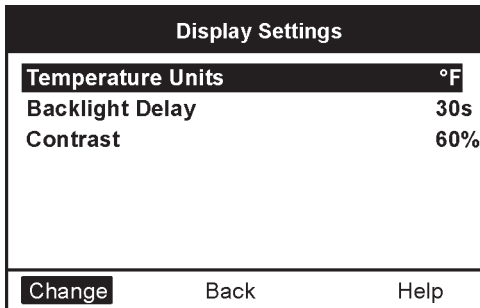

**ACTION:**

Press **Update** to accept the change or **Cancel** to reject it.

**DISPLAY:**

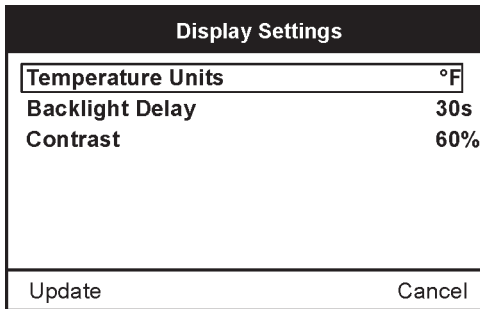

### 4. Fault Conditions

This water heater is equipped with electronic controls that have the ability to monitor almost all aspects of the water heater operation. In the case that there is an undesirable or unsafe condition that occurs, the water heater controls will detect this condition and determine the appropriate action. Part of this is displaying the information on the LCD in plain text that accurately describes the condition and diagnostics information that can be used to correct the issue.

• **Faults: This** is a safety related condition that has been detected by the heater.

NOTE: When these conditions occur, the water heater will not continue any further heating cycles and the water will no longer be heated until the condition is corrected and, in most cases, power has been cycled.

**Example of a Fault:**

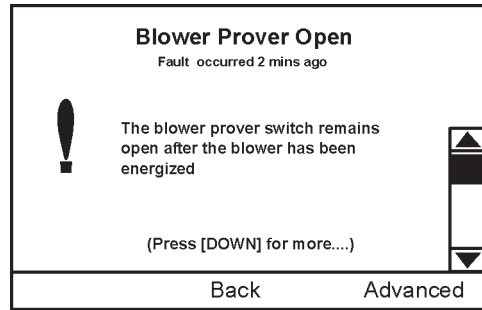

**Advanced Diagnostics Information**

When a fault has been declared, advanced information can be found in the control. By pressing the Advanced button, detailed information can be found regarding diagnosing and resolving the problem.

**WARNING: Usage of the Advanced information requires ability equivalent to that of a licensed tradesmen in the field involved.**

### 5. Access to the Current Fault

When a fault has been detected by the control, it will automatically be displayed on the screen and the back light will blink. If you choose to leave the current fault by pressing the Back key, you can always return to the fault screen through the menu.

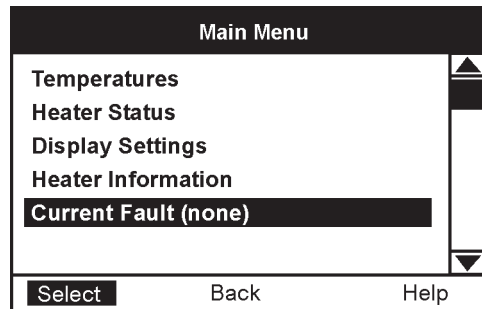

**ACTION:**

To get to the current fault information screen, press **Menu**.

**DISPLAY:**

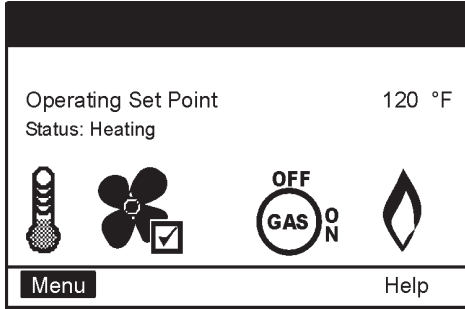

**ACTION:**

Press the **DOWN** button to highlight "current Fault" and press **Select**.

**DISPLAY:**

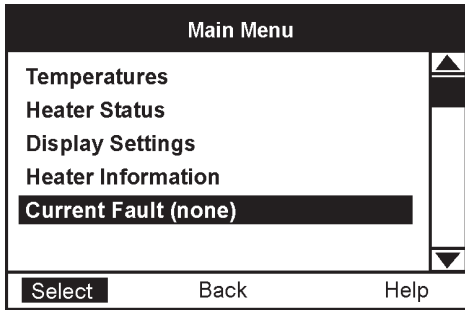

**ACTION:**

Press the **DOWN** button for more information.

**DISPLAY:**

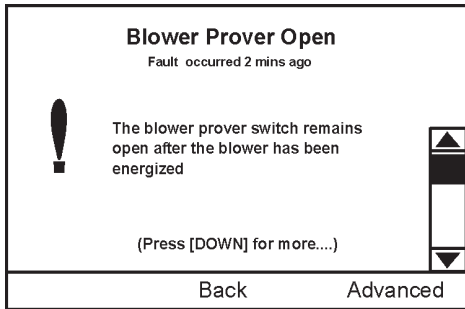

### 6. Viewing the Fault History

The controller for this water heater will store a history of ten of the last Fault conditions that occurred. This is stored in the Fault History. Along with all the information about the fault, including a estimate time of when the fault occurred, information regarding the advanced diagnostics for that fault can be accessed at any time.

**ACTION:**

Press the **DOWN** button for more information.

**DISPLAY:**

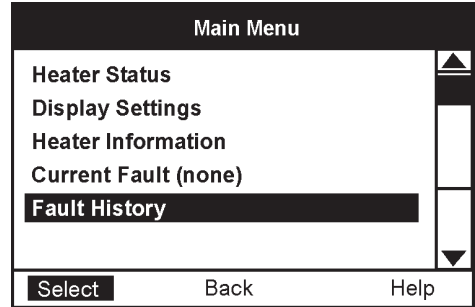

**ACTION:**

Press the **DOWN** key to scroll through the fault history. If you select a specific fault, you may press the **VIEW** button to view details regarding this fault.

**DISPLAY:**

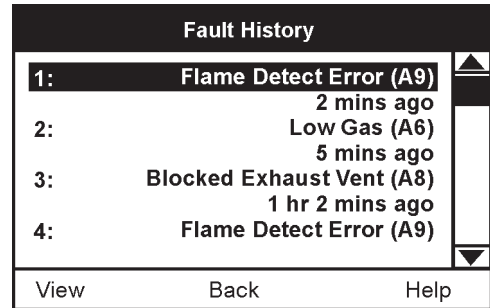

### 7. Viewing Information About the Heater

The electronic control for this water heater monitors many different aspects of the water to ensure safe and optimal operation. Much of the information monitored is available to view in two areas of the control. The first is the "Heater Status" and; the second is "Heater Information." These items can be selected through the main menu in the same fashion as described above. In these menus, detailed information about the water heater and the current status of specific conditions can be found.

# FOR YOUR INFORMATION

## START UP CONDITIONS

### SMOKE/ODOR

It is not uncommon to experience a small amount of smoke and odor during the initial start-up. This is due to burning off of oil from metal parts, and will disappear in a short while.

### THERMAL EXPANSION

## CAUTION

**Improper installation and use may result in property damage.**

- Avoid water heater damage.
- Install thermal expansion tank or device if necessary.
- Contact qualified installer or service agency.

Water supply systems may, because of such events as high line pressure, frequent cut-offs, the effects of water hammer among others, have installed devices such as pressure reducing valves, check valves, back flow preventers, etc. to control these types of problems. When these devices are not equipped with an internal bypass, and no other measures are taken, the devices cause the water system to be closed.

As water is heated, it expands (thermal expansion). In a closed system the volume of water will grow when it is heated. As the volume of water grows there will be a corresponding increase in water pressure due to thermal expansion. Thermal expansion can cause premature tank failure (leakage). This type of failure is not covered under the limited warranty. Thermal expansion can also cause intermittent temperature-pressure relief valve operation: water discharged from the valve due to excessive pressure build up. The temperature-pressure relief valve is not intended for the constant relief of thermal expansion. This condition is not covered under the limited warranty.

A properly sized thermal expansion tank should be installed on all closed systems to control the harmful effects of thermal expansion. Contact a local plumbing service agency to have a thermal expansion tank installed.

### STRANGE SOUNDS

Possible noises due to expansion and contraction of some metal parts during periods of heat-up and cool-down do not necessarily represent harmful or dangerous conditions.

Condensation causes sizzling and popping within the burner area during heating and cooling periods and should be considered normal. See "Condensate" in this section.

## OPERATIONAL CONDITIONS

### SMELLY WATER

In each water heater there is installed at least one anode rod (see parts section) for corrosion protection of the tank. Certain water conditions will cause a reaction between this rod and the water. The most common complaint associated with the anode rod is one of a "rotten egg smell" in the hot water. The smell is a result of four factors which must all be present for the odor to develop:

- a. A concentration of sulfate in the supply water.
- b. Little or no dissolved oxygen in the water.
- c. A sulfate reducing bacteria which has accumulated within the water heater (this harmless bacteria is nontoxic to humans).
- d. An excess of active hydrogen in the tank. This is caused by the corrosion protective action of the anode.

Smelly water may be eliminated or reduced in some water heater models by replacing the anode(s) with one of less active material, and then chlorinating the water heater tank and all water lines. Contact the local water heater supplier or a qualified service agency for further information concerning an Anode Replacement Kit and this chlorination treatment.

If the smelly water persists after the anode replacement and chlorination treatment, we can only suggest that chlorination or aeration of the water supply be considered to eliminate the water problem.

**Do not remove the anode leaving the tank unprotected. By doing so, all warranty on the water heater tank is voided.**

### "AIR" IN HOT WATER FAUCETS

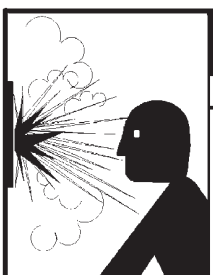

**WARNING**  
**Explosion Hazard**

- Flammable hydrogen gases may be present.
- Keep all ignition sources away from faucet when turning on hot water.

**HYDROGEN GAS:** Hydrogen gas can be produced in a hot water system that has not been used for a long period of time (generally two weeks or more). Hydrogen gas is extremely flammable and explosive. To prevent the possibility of injury under these conditions, we recommend the hot water faucet, located farthest away, be opened for several minutes before any electrical appliances which are connected to the hot water system are used (such as a dishwasher or washing machine). If hydrogen gas is present, there will probably be an unusual sound similar to air escaping through the pipe as the hot water faucet is opened. There must be no smoking or open flame near the faucet at the time it is open.

# PERIODIC MAINTENANCE

## VENTING SYSTEM INSPECTION

<b>⚠ WARNING</b>	
<b>Breathing Hazard - Carbon Monoxide Gas</b>	
	<ul style="list-style-type: none"><li>• Flue gases may escape if vent pipe is not connected.</li><li>• Be alert for obstructed, sooted or deteriorated vent system to avoid serious injury or death.</li><li>• Do not store corrosive chemicals in vicinity of water heater.</li><li>• Chemical corrosion of flue and vent system can cause serious injury or death.</li><li>• Analyze the entire vent system to make sure that condensate will not become trapped in a section of vent pipe and therefore reduce the open cross sectional area of the vent.</li></ul>
Breathing carbon monoxide can cause brain damage or death. Always read and understand instruction manual.	

At least once a year a visual inspection should be made of the venting system. You should look for:

1. Obstructions which could cause improper venting. The combustion and ventilation air flow must not be obstructed.
2. Damage or deterioration which could cause improper venting or leakage of combustion products.

Be sure the vent piping is properly connected to prevent escape of dangerous flue gasses which could cause deadly asphyxiation.

Obstructions and deteriorated vent systems may present serious health risk or asphyxiation.

Chemical vapor corrosion of the flue and vent system may occur if air for combustion contains certain chemical vapors. Spray can propellants, cleaning solvents, refrigerator and air conditioner refrigerants, swimming pool chemicals, calcium and sodium chloride, waxes, bleach and process chemicals are typical compounds which are potentially corrosive.

If after inspection of the vent system you found sooting or deterioration, something is wrong. Call the local gas utility to correct the problem and clean or replace the flue and venting before resuming operation of the water heater.

## BURNER OPERATION AND INSPECTION

Flood damage to a water heater may not be readily visible or immediately detectable. However, over a period of time a flooded

water heater will create dangerous conditions which can cause DEATH, SERIOUS BODILY INJURY, OR PROPERTY DAMAGE. Contact a qualified installer or service agency to replace a flooded water heater. Do not attempt to repair the unit! It must be replaced!

At least once a year a visual inspection should be made of the main burner and the hot surface igniter assembly for proper flame characteristics and ignition sequences. You should also check for sooting. Soot is not normal and will impair proper combustion. A visual inspection of the main burner and HSI igniter assembly should also be done at least once a year.

Soot build-up indicates a problem that requires correction before further use. Turn "OFF" gas to water heater and leave off until repairs are made, because failure to correct the cause of the sooting can result in a fire causing death, serious injury, or property damage.

## BURNER CLEANING

In the event your burner or burner air openings require cleaning, turn the on/off switch to the "OFF" position and allow the unit to cool. Call a qualified service agency to remove and clean the burner and correct the problem that required the burner to be cleaned.

## HOUSEKEEPING

Vacuum around base of water heater for dust, dirt, and lint on a regular basis.

<b>⚠ DANGER</b>	
<b>Fire and Explosion Hazard</b>	
	<ul style="list-style-type: none"><li>• Do not obstruct combustion air openings at the bottom of the water heater.</li><li>• Do not use or store flammable vapor products such as gasoline, solvents or adhesives in the same room or area near water heater or other appliance.</li><li>• Can cause serious injury or death.</li></ul>

INSTALLED IN SUITABLE AREA: To insure sufficient ventilation and combustion air supply, proper clearances from the water heater must be maintained. See "Facts to Consider About Location" section. Combustible materials such as clothing, cleaning materials, or flammable liquids, etc. must not be placed against or adjacent to the water heater which can cause a fire.

## ANODE ROD INSPECTION

<b>CAUTION</b>
<b>Property Damage Hazard</b>
<ul style="list-style-type: none"> <li>• Avoid water heater damage.</li> <li>• Inspection and replacement of anode rod required.</li> </ul>

The anode rod is used to protect the tank from corrosion. Most hot water tanks are equipped with an anode rod. The submerged rod sacrifices itself to protect the tank. Instead of corroding the tank, water ions attack and eat away the anode rod. This does not affect the water's taste or color. The rod must be maintained to keep the tank in operating condition.

Anode deterioration depends on water conductivity, not necessarily water condition. A corroded or pitted anode rod indicates high water conductivity and should be checked and/or replaced more often than an anode rod that appears to be intact. Replacement of a depleted anode rod can extend the life of your water heater. Inspection should be conducted by a qualified technician, and at a minimum should be checked annually after the warranty period.

## TEMPERATURE-PRESSURE RELIEF VALVE OPERATION

<b>▲ DANGER</b>	<ul style="list-style-type: none"> <li>• Burn hazard.</li> <li>• Hot water discharge.</li> <li>• Keep clear of relief valve discharge outlet.</li> </ul>

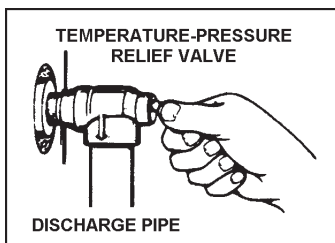

FIGURE 28.

When checking the temperature-pressure relief valve operation, make sure that (1) no one is in front of or around the outlet of the temperature-pressure relief valve discharge line, and (2) that the water discharge will not cause any property damage, as the water may be extremely hot, see Figure 28.

If after manually operating the valve, it fails to completely reset and continues to release water, immediately close the cold water inlet to the water heater, follow the draining instructions, and replace the temperature-pressure relief valve with a new one.

If the temperature-pressure relief valve on the appliance weeps or discharges periodically, this may be due to thermal expansion. You may have a check valve installed in the water line or a water meter with a check valve. Consult your local water supplier or a qualified service agency for further information. Do not plug the temperature-pressure relief valve.

## DRAINING

<b>▲ DANGER</b>	<ul style="list-style-type: none"> <li>• Burn hazard.</li> <li>• Hot water discharge.</li> <li>• Keep hands clear of drain valve discharge.</li> </ul>

The water heater should be drained if being shut down during freezing temperatures. Also periodic draining and cleaning of sediment from the tank may be necessary.

1. Set the power switch to the "OFF" position.
2. CLOSE the cold water inlet valve to the water heater.
3. OPEN a nearby hot water faucet and leave open to allow for draining.
4. Connect a hose to the drain valve and terminate to an adequate drain.
5. OPEN the water heater drain valve to allow for tank draining.

**NOTE:** If the water heater is going to be shut down and drained for an extended period, the drain valve should be left open with hose connected allowing water to terminate to an adequate drain.

6. CLOSE the drain valve.
7. Follow instructions in the "Filling The Water Heater" section.
8. Follow the lighting instructions on the label or see "Lighting Instructions" in this manual to restart the water heater.

## SERVICE

If a condition persists or you are uncertain about the operation of the water heater contact a qualified service agency.

Use this guide to check a "Leaking" water heater. Many suspected "Leakers" are not leaking tanks. Often the source of the water can be found and corrected.

If you are not thoroughly familiar with gas codes, your water heater, and safety practices, contact your gas supplier or qualified installer to check the water heater.

Read this manual first. Then before checking the water heater make sure the gas supply has been turned "OFF", and never turn the gas "ON" before the tank is completely full of water.

## LEAKAGE CHECKPOINTS

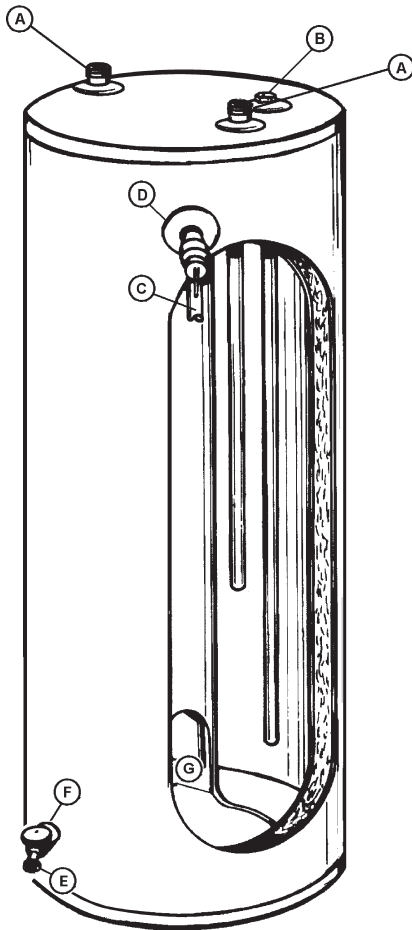

Never use this water heater unless it is completely filled with water. To prevent damage to the tank, the tank must be filled with water. Water must flow from the hot water faucet before turning "ON" gas to the water heater.

- A \*Condensation may be seen on pipes in humid weather or pipe connections may be leaking.
- B. \*The anode rod fitting may be leaking.
- C. Small amounts of water from temperature-pressure relief valve may be due to thermal expansion or high water pressure in your area.
- D. \*The temperature-pressure relief valve may be leaking at the tank fitting.
- E. Water from a drain valve may be due to the valve being slightly opened.
- F. \*The drain valve may be leaking at the tank fitting.
- G. Combustion products contain water vapor which can condense on the cooler surfaces of the tank. Droplets form and drip onto the burner or run on the floor. This is common at the time of start-up after installation and when incoming water is cold.
- H. Water in the water heater bottom or on the floor may be from condensation, loose connections, or the relief valve. DO NOT replace the water heater until a full inspection of all possible water sources is made and necessary corrective steps taken.

Leakage from other appliances, water lines, or ground seepage should also be checked.

- \* To check where threaded portion enters tank, insert cotton swab between jacket opening and fitting. If cotton is wet, follow "Draining" instructions in the "Periodic Maintenance" section and then remove fitting. Put pipe dope or teflon tape on the threads and replace. Then follow "Filling the Water Heater" instructions in the "Installing the New Water Heater" section.



### ⚠ WARNING

Read and understand instruction manual and safety messages before installing, operating or servicing this water heater.

Failure to follow instructions and safety messages could result in death or serious injury.

Instruction Manual must remain with water heater.

# TROUBLESHOOTING GUIDELINES

These guidelines should be utilized by a qualified service agent.

<b>PROBLEMS</b>		
<b>NOT ENOUGH HOT WATER</b>	1.) Blower will not run.	
	a. "ON/OFF" control switch turned off.	Turn switch to the "ON" position.
	b. Blower unplugged.	Plug blower back into 115 VAC outlet.
	c. No power at outlet.	Repair service to outlet.
	d. Thermostat defective.	Replace thermostat.
	e. Control harness defective.	Replace control harness.
	f. High limit control circuit open.	Reduce the water temperature below 140°F. Turn the power switch to the off position. Wait 10 seconds. Turn the power switch to the on position. Reduce the temperature set point to minimize likelihood of reoccurrence. If this does not solve the problem, replace the thermostat.
	g. Blower motor defective.	Replace blower assembly.
	2.) Thermostat problems	
	a. Thermostat set too low.	Adjust temperature control higher.
	b. Thermostat or ECO defective	Replace thermostat.
	3.) Others	
	a. Heater undersized..	Reduce hot water use.
	b. Low gas pressure	Contact dealer.
	c. Incoming water is usually cold.	Allow more time for heater to reheat.
	d. Leaking hot water pipes or fixtures.	Have plumber check and repair leaks.
e. Heater not lit or thermostat not on.	Refer to LIGHTING INSTRUCTIONS.	
<b>VENT PIPE TOO HOT (ABOVE 170°F [77°C])</b>	Wrong burner orifice.	Turn off heater and gas, clean burner head.
<b>YELLOW FLAME</b>	Dirt in burner ports.	Turn off heater and gas, clean burner head.
	Combustion air path restricted.	Check exhaust venting and air openings in bottom base pan for obstructions or blockage.
<b>CONDENSATION</b>	Water on the floor under heater.	See CONDENSATION section.
<b>WATER LEAKS</b>	Improperly sealed, hot or cold supply connections, relief valve, drain valve or thermostat threads.	Check for leaks. See Figure 1.
	Leakage from other appliances or water lines.	Inspect other appliances near water heater.
	Condensation of flue products.	Refer to CONDENSATION section.
<b>LEAKING T &amp; P</b>	Thermal expansion in closed water system.	Install thermal expansion tank (Do not plug T&P valve).
	Improperly sealed valve.	Check relief valve for proper operation (Do not plug T&P valve).
<b>HOT WATER ODORS (refer to cathodic protection)</b>	High sulfate or mineral content in water supply.	Drain and flush heater thoroughly then refill.
	Bacteria in water supply.	Chlorinate water supply.
<b>HOT WATER TOO HOT</b>	Thermostat set too high.	Refer to TEMPERATURE REGULATION section.
<b>WATER HEATER SOUNDS</b>	Condensation dripping on burner.	Refer to CONDENSATION above.
<b>SIZZLING - RUMBLING</b>	Sediment at bottom of heater tank.	Clean sediment from tank. Refer to DRAINING.
<b>SOOTING</b>	Improper combustion.	Refer to Air Requirements.
<b>BURNER WILL NOT STAY LIT-GOES OUT 4-5 SECONDS</b>	Outlet polarity is reversed.	Test polarity and correct.
	High ambient room temperature.	Contact a qualified service agency to determine cause.
	Defective gas control valve thermostat.	Replace gas control valve thermostat.
<b>VENT GAS ODORS</b>	Lack of air supply.	Shut off water heater immediately and contact a qualified service agency to determine cause.
	Improperly installed vent piping.	
	Downdraft	
	Poor Combustion	



# NOTES

---

# NOTES

# LIMITED RESIDENTIAL GAS WARRANTY

THIS WARRANTY IS APPLICABLE TO THE ORIGINAL OWNER ONLY. If the glass lined tank in this water heater should prove upon examination by (the warrantor) to have leaked during the warranty period in normal residential use, due to natural corrosion from potable water therein, the warrantor will furnish the ORIGINAL OWNER a replacement water heater of equivalent size and current model, or a replacement part for any component part which fails in normal use, in accordance with the warranty terms and conditions specified below. THE WATER HEATER REPLACEMENT MODEL OR PART WILL BE WARRANTED FOR ONLY THE UNEXPIRED PORTION OF THE ORIGINAL WARRANTY. The warranty period will be determined by the original installation date of the water heater. PROOF-OF-PURCHASE AND PROOF-OF-INSTALLATION ARE NECESSARY TO VALIDATE THIS WARRANTY. This warranty is not transferable.

WARRANTY PERIOD		
Product Line	TANK <sup>1</sup>	PARTS <sup>2</sup>
GP650YTPDT	6 YEARS	6 YEARS

When the water heater has been used for other than single family residential application: 1. The Tank warranty should be reduced to 3 years on 10 year models and 1 year on 6 and 8 year models. 2. The parts warranty should be reduced to 1 year for all models. Returned parts which meet any of the following conditions are not covered by this warranty: 1) improper installation or removal; 2) damaged by other than normal wear; 3) replaced for cosmetic purposes; or 4) returned with defaced date codes.

## CONDITIONS AND EXCEPTIONS

This warranty should apply only when the water heater is installed and operated in accordance with: 1) all local fire codes and plumbing codes, ordinances and regulations; 2) the printed instructions provided with it; 3) good industry practices; and 4) proper safety practices such as but not limited to a properly sized drain pan if installed in an area where leakage from connections of the tank would result in damage to the area adjacent to the heater. In addition, a new temperature and pressure relief valve, certified by the Canadian Standards Association must have been properly installed and piped to the nearest drain.

This warranty should apply only when the heater is:

- owned by the original purchaser;
- used at temperatures not exceeding the maximum calibrated setting of its thermostat;
- not subjected to excessive water pressure fluctuations and not subject to an operating pressure greater than 150 P.S.I.;
- filled with potable water, free to circulate at all times and with the tank free of damaging water sediment or scale deposits;
- used in a non-corrosive and non-contaminated atmosphere;
- used with factory approved anode(s) installed;
- in its original installation location;
- in the United States and its territories or possessions or Canada;
- sized in accordance with proper sizing techniques for residential water heaters;
- bearing a rating plate which has not been altered, defaced or removed except as required by the warrantor;
- used in an open system or in a closed system with a properly sized and installed thermal expansion tank;
- fired at the factory rated input using the fuel stated in the face of the rating plate;
- operated with the inner and outer combustion chamber doors in place;
- maintained in accordance with the instructions printed in the manual included with the heater.

Any accident to the water heater or any part thereof (including freezing, fire, floods, or lightning), any misuse, abuse or alteration of it, any operation of it in a modified form, or any attempt to repair tank leaks or parts, will void this warranty.

## SERVICE AND LABOR RESPONSIBILITY

UNDER THIS LIMITED WARRANTY, THE WARRANTOR WILL PROVIDE ONLY A REPLACEMENT WATER HEATER OR PART THEREOF. THE OWNER IS RESPONSIBLE FOR ALL OTHER COSTS. Such costs may include but are not limited to:

a. Labor charges for service, removal, or reinstallation of the water heater or part thereof.

b. Shipping and delivery charges for forwarding the new water heater or replacement part from the nearest distributor and returning the claimed defective heater or part to such distributor except in the state of California where such charges are the manufacturer's responsibility.

c. All cost necessary or incidental for handling and administrative charges, and for any materials and/or permits required for installation of the replacement heater or part.

## LIMITATION ON IMPLIED WARRANTIES

Implied warranties, including any warranty of merchantability imposed on the sale of this heater under state law are limited to one year duration for the heater or any of its parts. Some states do not allow limitations on how long an implied warranty lasts, so the above limitations may not apply to you.

## CLAIM PROCEDURE

Any claim under this warranty should be initiated with the dealer who sold the heater, or with any other dealer handling the warrantor's products.

The warrantor will only honor replacement with identical or similar water heater or parts thereof which are manufactured or distributed by the warrantor.

Dealer replacements are made subject to in-warranty validation by warrantor.

PROOF-OF-PURCHASE AND PROOF-OF-INSTALLATION DATES ARE REQUIRED TO SUPPORT WARRANTY FOR CLAIM FROM ORIGINAL OWNER. THIS FORM DOES NOT CONSTITUTE PROOF-OF-PURCHASE OR PROOF-OF-INSTALLATION.

## DISCLAIMERS

NO EXPRESS WARRANTY HAS BEEN OR WILL BE MADE IN BEHALF OF THE WARRANTOR WITH RESPECT TO THE MERCHANTABILITY OF THE HEATER OR THE INSTALLATION, OPERATION, REPAIR OR REPLACEMENT OF THE HEATER OR PARTS. THE WARRANTOR Should NOT BE RESPONSIBLE FOR WATER DAMAGE, LOSS OF USE OF THE UNIT, INCONVENIENCE, LOSS OR DAMAGE TO PERSONAL PROPERTY, OR OTHER CONSEQUENTIAL DAMAGE. THE WARRANTOR Should NOT BE LIABLE BY VIRTUE OF THIS WARRANTY OR OTHERWISE FOR DAMAGE TO ANY PERSONS OR PROPERTY, WHETHER DIRECT OR INDIRECT, AND WHETHER ARISING IN CONTRACT OR IN TORT.

Some states do not allow the limitation or exclusion of incidental or consequential damages, so the above limitation or exclusion may not apply to you.

This warranty gives you specific legal rights, and you may also have other rights which vary from state to state. Should governmental regulations or industry standards prohibit the Manufacturer from furnishing a comparable model replacement under this warranty, the Owner will be furnished with the closest comparable water heater meeting the current governmental regulations and industry standards. A supplementary fee may be assessed to cover the additional cost associated with the changes made to meet applicable regulations and standards.

Fill out and keep with water heater.

## IMPORTANT INFORMATION

Model Number _____
Serial Number _____
Installation Information: _____
Date Installed _____
City, State, and Zip Code Phone Number _____
Company's Name _____
Street or P.O. Box _____
City, State, and Zip Code _____
Phone Number _____ Plumber's Name _____



500 Tennessee Waltz Parkway, Ashland City, TN 37015  
Phone: 800-365-0024 • Fax: 800-644-9306  
Website: [www.statewaterheaters.com](http://www.statewaterheaters.com)