



ecobee

# Smart Si Thermostat Installation Manual

# CONTENTS

<b>GETTING STARTED</b>	<b>1</b>
Welcome	1
Technical Support	1
Before You Begin	2
HVAC System Compatibility Information	3
Approvals	4
FCC Compliance Statement	4
Specifications	5
Wiring Requirements	6
<b>INSTALLING THE SMART Si THERMOSTAT</b>	<b>7</b>
Step 1. Power Off HVAC Equipment	7
Step 2. Remove Existing Thermostat	7
Step 3. Install the Smart Si Thermostat	7
Step 4. Connect the Wiring	9
Step 5. Power On HVAC Equipment	20

<b>NAVIGATING THE MENUS</b>	<b>20</b>
<b>CONFIGURING THE SMART Si THERMOSTAT</b>	<b>22</b>
Equipment	22
Thresholds	24
Test Equipment	28
Reset HVAC Equipment Settings	29
Performing a Hardware Reset	29
Rebooting the Smart Si Thermostat	29
Configuring Reminders and Alerts	30
Alerts	31
List of Alerts	32
<b>3-YEAR LIMITED WARRANTY</b>	<b>33</b>



# GETTING STARTED

## *Welcome*

The ecobee Smart Si thermostat has been designed in partnership with HVAC contractors to ensure the installation process is simple and efficient. This step-by-step Installation Manual will walk you through all aspects of the installation.

To ensure an on-going service relationship with your customers, please register all of your ecobee thermostats in your Contractor Portal.

## *Technical Support*

Our technical support team is available to answer your questions at **1.877.932.6233**, or via email at **[support@ecobee.com](mailto:support@ecobee.com)**.

## ***Before You Begin***

This product is intended to be installed by trained service professionals.

This manual explains the procedures for installing the ecobee Smart Si thermostat. Please read it carefully before beginning the installation.

For information on how to operate the ecobee Smart Si thermostat, please see the Smart Si Thermostat User Manual.

The Smart Si thermostat is designed to be mounted on the homeowner's wall in a convenient location.

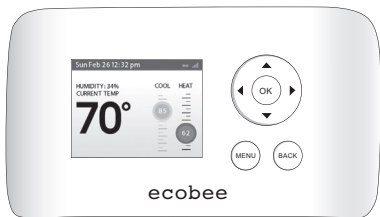

***Caution:*** Disconnect electric power to the HVAC system before installing this product. Failure to do so could result in electric shock and/or equipment damage.

*All wiring must conform to your local electrical code.*

***Mercury Notice:*** This product does not contain mercury. If you are replacing a product that does contain mercury, contact your local waste-management authority for disposal instructions. Do not discard the old product in the regular trash.

## ***HVAC System Compatibility Information***

The Smart Si thermostat is designed to operate with low-voltage heating and cooling systems. It is not designed for use with line-voltage or millivolt heating and cooling systems.

The Smart Si thermostat supports:

- Up to 2 heat and 2 cool stages on a conventional system.
- Up to 3 heat and 2 cool stages on a heat pump system.

The ecobee Smart Si thermostat supports the following equipment:

<b>Equipment</b>	<b>Supported?</b>
Gas/Oil/Electric heating (up to two stages)	Yes
Heat pump with auxiliary heat (up to three stages)	Yes
Geothermal Heat Pump	Yes
Dual fuel systems	Yes
Standard electric cooling (up to two stages)	Yes
Boilers	Yes

## ***Approvals***

This product was designed and built in accordance to RoHS directive 2002/95/EC and contains no hazardous substances as defined by this directive.

## ***FCC Compliance Statement***

This equipment has been tested and found to comply with the limits for Class B digital devices, pursuant to Part 15 of the FCC Rules. These limits are designed to provide reasonable protection against harmful interference in a residential installation. This equipment generates, uses, and can radiate radio frequency energy and, if not installed and used in accordance with the instruction manual, may cause harmful interference to radio communications. However, there is no guarantee that interference will not occur in a particular installation. If this equipment does cause harmful interference to radio or television reception, which can be determined by turning the equipment off and on, the user is encouraged to try to correct the interference by one or more of the following measures:

- Reorient or relocate the receiving antenna.
- Increase the separation between the equipment and receiver.
- Connect the equipment to an outlet on a different circuit from the receiver.
- Consult the dealer or an experienced radio/TV contractor for help.

To satisfy FCC/IC RF exposure safety requirements, a separation distance of 8 inches (20 cm) or more should be maintained between this device and persons. To ensure compliance, operation at closer than this distance is not allowed.



Warning: Changes or modifications not expressly approved by ecobee Inc. could void the user's authority to operate the equipment.

## ***Specifications***

### **Temperature ranges**

Heat: 45 to 79 °F (7 to 26 °C)  
Cool: 45 to 92 °F (14 to 33 °C)  
Display: 40 to 100 °F (5 to 37 °C)  
Sensitivity: +/- 1 °F (0.5 °C)  
Operating: 32 to 130 °F (0 to 55 °C)

### **Humidity Range**

Display: 20 to 90% R.H.  
Sensitivity: +/- 5% R.H.  
Operating: 5 to 95% R.H (non-condensing)

### **Dimensions**

Thermostat: 5.5"W x 3.25"H x 1"D  
(139.5mm H x 82.5mm W x 25mm D)

### **Power**

24 VAC (3VA minimum)

## Wiring Requirements

The following table shows the maximum wire lengths allowed:

### Thermostat to HVAC Equipment

18 AWG	20 AWG	22 AWG
128 ft/380 m	80 ft/240 m	50 ft/150 m

### Terminal Description and Electrical Ratings

Terminal	Description	Voltage	Current Max
N/C	Unused	N/A	N/A
Y	1st stage compressor	30V AC	3A
W (O/B)	1st stage heating or reversing valve changeover	30V AC	3A
G	Fan	30V AC	3A
RC	Cool transformer *	30V AC	3A
RH	Heat transformer *	30V AC	3A
C	Common	30V AC	3A
Y2	2nd stage compressor	30V AC	3A
W2 (AUX)	2nd stage heating or 1st stage auxiliary heat	30V AC	3A

*\* Factory jumper installed between RC and RH. Remove jumper for 2-transformer applications. See wiring diagrams for additional information.*

# INSTALLING THE SMART Si THERMOSTAT

There are 5 steps to install the ecobee Smart Si thermostat:

Step 1. Power Off HVAC Equipment

Step 2. Remove Existing Thermostat

Step 3. Install the Smart Si Thermostat

Step 4. Connect the Wiring

Step 5. Power On HVAC Equipment

## ***Step 1. Power Off HVAC Equipment***

Before disconnecting the existing thermostat, or installing the Smart Si thermostat, disconnect the power to the heating and air conditioning equipment.

## ***Step 2. Remove Existing Thermostat***

Disconnect the wires to the existing thermostat and remove it from the wall (if you are installing the Smart Si thermostat in the same location).

## ***Step 3. Install the Smart Si Thermostat***

The ideal location for the thermostat is approximately 5 ft (1.5 m) above floor level in the main living area.

Do not install the thermostat:

- Close to sources of heat such as incandescent lights
- Near supply heating/cooling sources
- In direct sunlight
- On exterior, non-insulated or poorly insulated walls

- In the kitchen or other areas of potentially high heat and/or humidity
- In an area that could restrict air flow

To install the thermostat:

1. Gently separate the backplate from the thermostat.
2. Place the thermostat backplate on the wall. Make sure that any existing wires can be inserted through the opening for the wiring.
3. Using the backplate as a template, mark the location of the mounting holes on the wall as shown below.

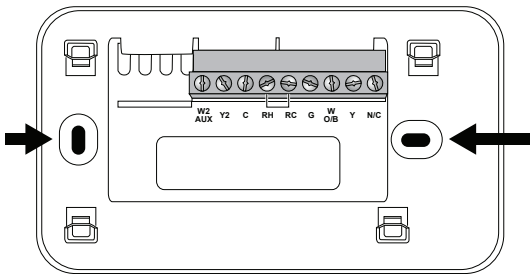

*The solid color indicates mounting holes*

4. Move the backplate out of the way and make holes where indicated in step 3. The mounting holes can accommodate a #6 pan-head screw. It is recommended to use the included fasteners to ensure proper fitting of the front housing.
5. Use the included drywall plugs (or other suitable anchors) to ensure the thermostat can be mounted securely to the wall.
6. Fasten the backplate to the wall using the screws provided (or other suitable screws).

## ***Step 4. Connect the Wiring***

You need to use low-voltage cable to connect the thermostat to the HVAC equipment. Check the wiring diagrams on pages 8 to 17 for the number of wires required.

Note: There is a factory installed jumper between R/H and R/C. Ensure any unused wires do not have exposed bare copper conductors.

To connect the thermostat to the equipment:

1. Connect the wires as shown in the wiring diagrams.
2. Attach the Smart Si thermostat to the backplate. Ensure that the pins on the thermostat align with the terminal block on the backplate.

### **Wiring Diagrams**

The following diagrams show how to connect the thermostat terminals to various HVAC equipment.

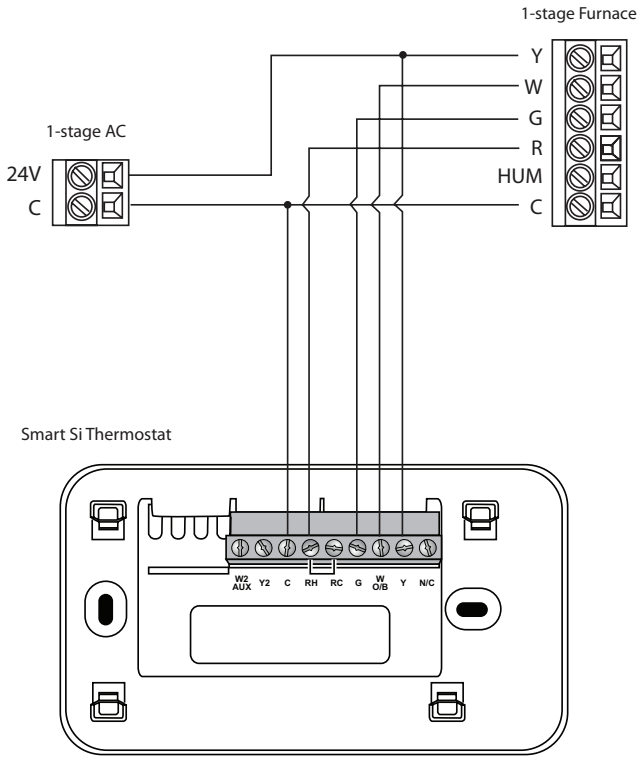

*Single stage heat/cool*

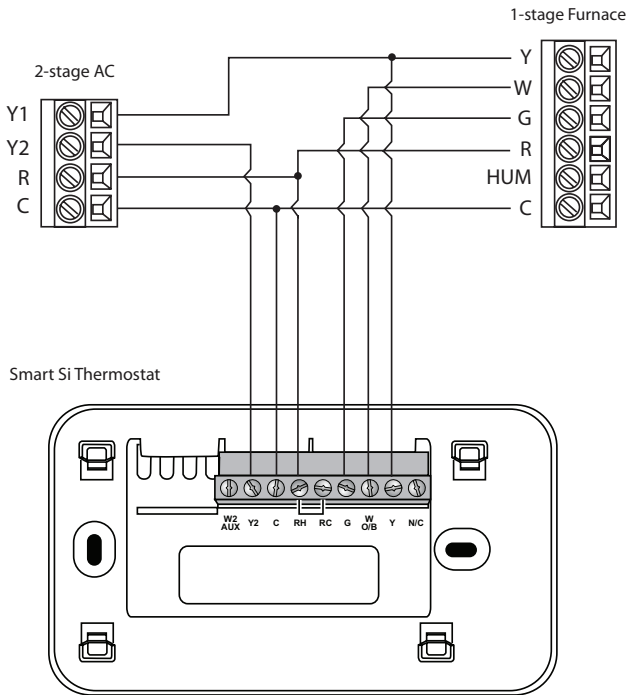

*Single stage heat, dual stage cool*

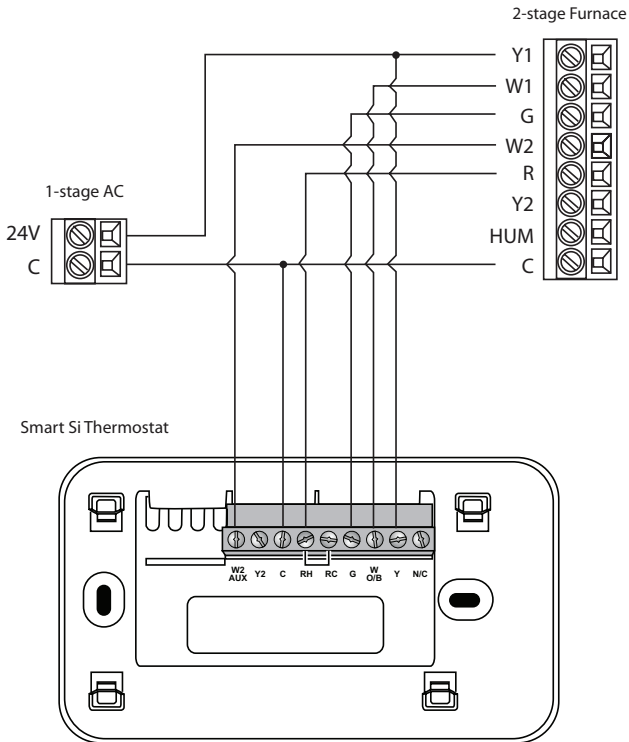

*Dual stage heat, single stage cool*



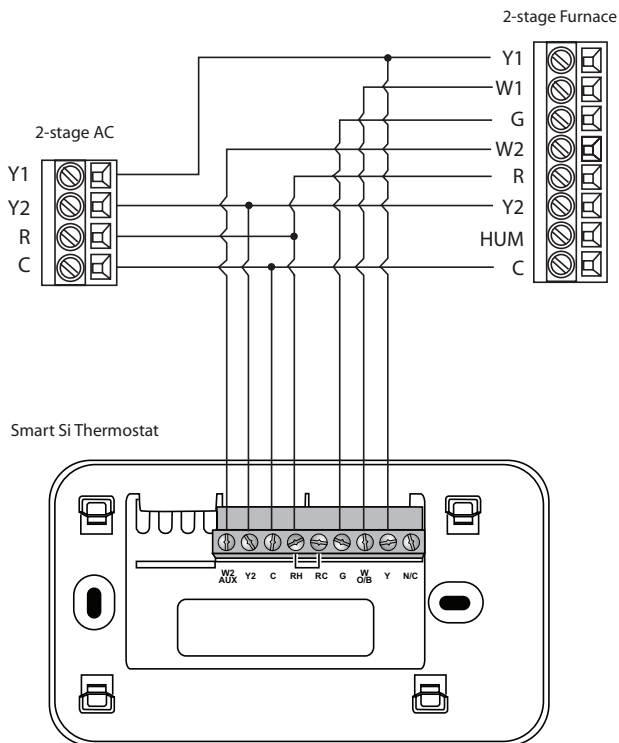

*Dual stage heat, dual stage cool*

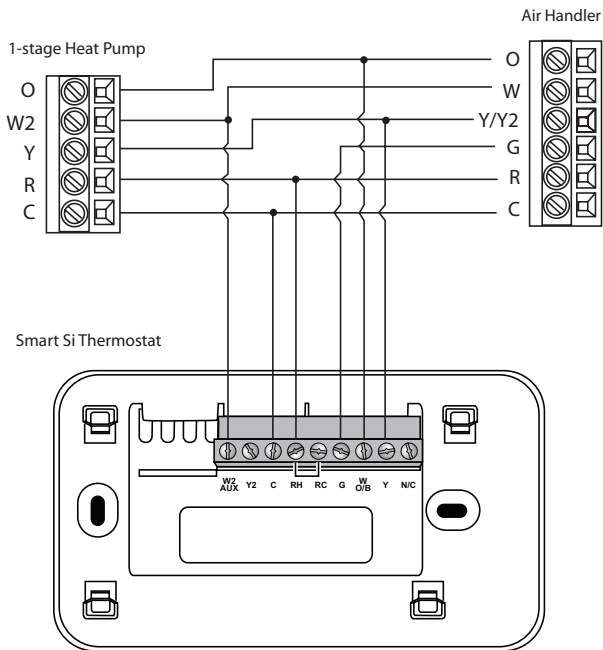

*Single stage heat pump with auxiliary heat*

2-stage Heat Pump

Air Handler

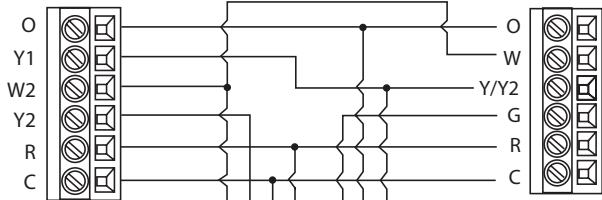

Smart Si Thermostat

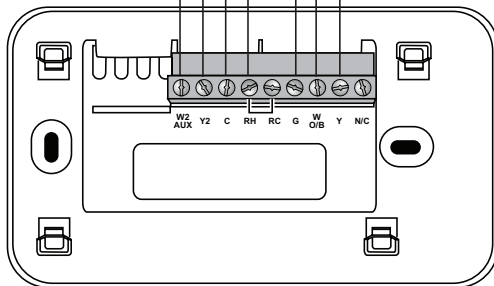

*Dual stage heat pump with auxiliary heat*

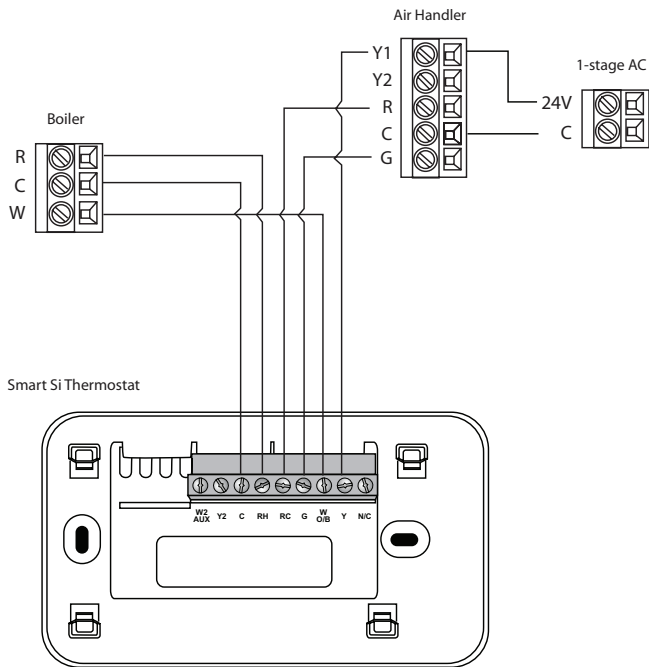

*\* Remove RH/RC factory jumper*

*C terminal to be connected to heating transformer common*

*Boiler with air handler and single-stage cool*

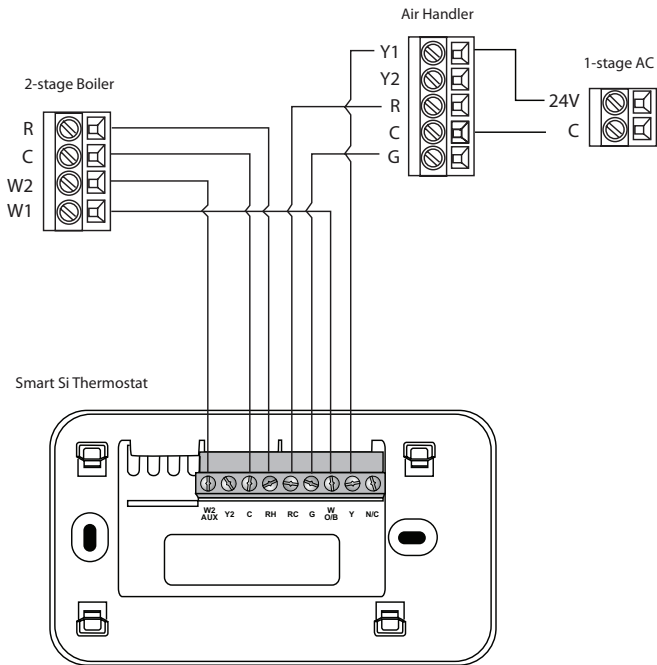

*\* Remove RH/RC factory jumper*

*C terminal to be connected to heating transformer common*

*Dual stage boiler with air handler and single stage cool*

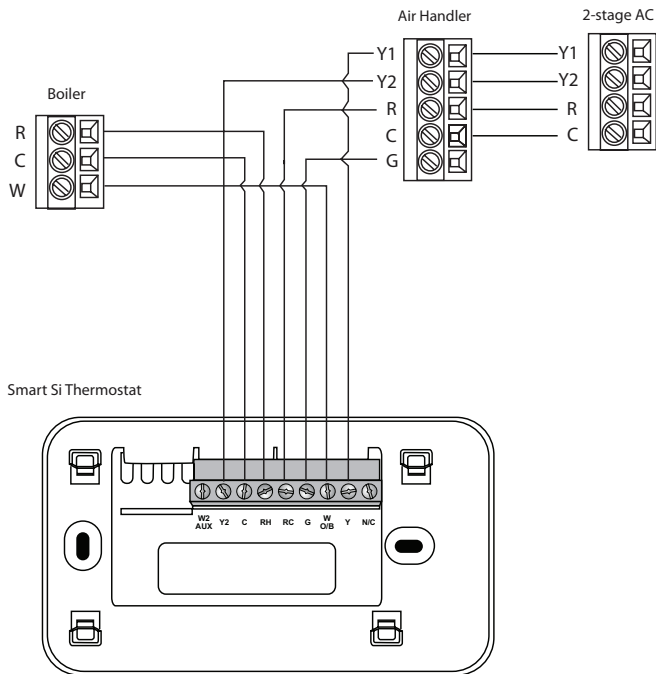

*\* Remove RH/RC factory jumper*

*C terminal to be connected to heating transformer common*

*Single stage boiler with air handler, dual stage cool*

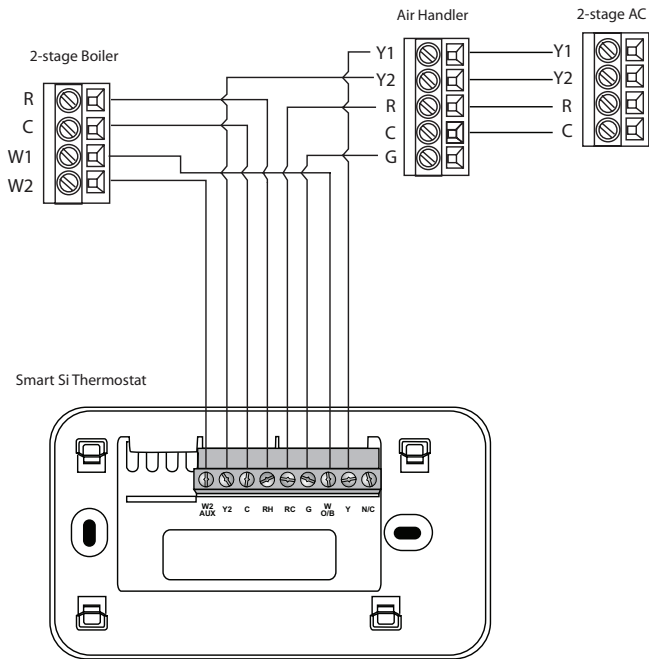

*\* Remove RH/RC factory jumper*

*C terminal to be connected to heating transformer common*

*Dual stage boiler with air handler, dual stage cool*

## ***Step 5. Power On HVAC Equipment***

After you've completed the wiring, you can apply power to the heating and air conditioning equipment. The Smart Si thermostat receives power from the equipment and will automatically power on.

## **NAVIGATING THE MENUS**

The Smart Si thermostat has an easy-to-read color screen that displays all the information you need to configure the thermostat. Use the navigation buttons on the right to quickly change the temperature, access features, and configure settings.

### ***Using the Navigation Buttons***

The navigation buttons located on the right of the Smart Si thermostat let you select options and control the Smart Si thermostat.



- **▲ (up)** On the Home screen, press ▲ to increase the temperature set point by 1°F (0.5°C). For menus, press ▲ to move up.
- **▼ (down)** On the Home screen, press ▼ to decrease the temperature set point by 1°F (0.5°C). For menus, press ▼ to move down.
- **◀ (left)** On the Home screen, if Auto mode is enabled, press ◀ to switch between heat and cool set points. For menus, press ◀ to go back to the previous screen.



- **▶ (right)** On the Home screen, if Auto mode is enabled, press ▶ to switch between heat and cool set points. For menus, press ▶ to choose the currently highlighted option.
- **OK** On a menu screen, press **OK** to choose the currently highlighted option. If a configuration option is selected, pressing **OK** will keep its new value and return back to the previous screen.
- **MENU** Pressing **MENU** displays a list of all available options. If a menu is currently displayed, pressing **MENU** will cancel any unsaved changes and return to the Home screen.
- **BACK** On a menu screen, press **BACK** to go back to the previous screen.



## On-Screen Keyboard

If you need to type in any information, an on-screen keyboard will appear. To enter a letter or number, move to the character by pressing the arrow keys and then press **OK** to select it.

Select **Caps** to enter capital letters; select **&@#** to enter commonly used symbols. If you make a mistake, press **X** to delete the text .

To keep your changes, select **Save**. To cancel your changes, press **BACK**.

# CONFIGURING THE SMART Si THERMOSTAT

The first step after installing the Smart Si thermostat is to configure the settings for the various devices (such as a furnace or air conditioner) that are being connected.

## *To configure the equipment settings:*

From the Home screen, press MENU.

Select **Settings** ► **Installation Settings**.

Select **Equipment**.

Configure the devices connected to the thermostat.

## *Equipment*

The Equipment settings let you configure the devices connected to the thermostat.

### **Heat Pump**

This section lets you configure a heat pump with up to 2 heat/2 cool stages plus an auxiliary heat source.

- **Geothermal heat pump** Select Yes if you are using a geothermal heat pump. This helps the thermostat determine optimum performance and default settings. If you select No, the system will optimize the settings for an air-to-air heat pump.
- **OB energize on cool** If you choose Yes, the reversing valve output (O/B terminal) will activate when there is a call for cooling. If you select No, the relay will activate when there is call for heat.
- **Min Cycle Off Time** Configures the minimum compressor off time between cycles (240 to 900 seconds).
- **Min Outdoor Temp** Disables the compressor when the outside air temperature reaches the configured minimum setting. This performs two functions. It prevents the compressor

from running when the outdoor temperature is too low, thus resulting in damage to the compressor. You can also set this value to determine when you want the auxiliary heat (if installed) to engage to help meet the set temperature. The temperature range is adjustable from 0 to 65 °F (-17.8 to 18.3 °C) or can be completely disabled. Note: You need an internet connection for this feature to operate properly.

- **Allow HP with Aux Heat** If you select Yes and there is a source of auxiliary heat, it will turn on in addition to the heat pump. The heat pump will be energized for the first 30 minutes. If, after 30 minutes, the set point has not been met, the auxiliary heat will be energized to assist the heat pump in meeting the load.

If you select No, the heat pump will be energized for up to 2 hours. If after 2 hours the set point has not been met, the thermostat will shutdown the heat pump and energize the auxiliary heat to meet the set point. This option should also be used for installation where the heat pump evaporator coil is downstream from the source of auxiliary heat.

This setting is only available the Comp to Aux Temp Delta and Comp to Aux Runtime settings are both set to Auto (default)

## Furnace

Allows you to enable and configure up to a 2-stage conventional heat source. If you have selected a heat pump as your primary source, this feature allows you to configure the 1st stage of auxiliary heat connected to the system.

- **Furnace Type** Allows you to configure the type of furnace. This helps the thermostat

optimize its algorithms based on the type of fuel and typical characteristics of the chosen system. Choose the option that best represents the type of heating system installed.

- **Heat Fan Control** Configures the furnace fan to be controlled by the Smart Si thermostat or the HVAC system during heat cycles. Normally the HVAC system controls the fan during heat cycles.

## Air Conditioner

Configures up to 2 stages of air conditioning. If you require a second stage, you must enable the Y2 relay.

## Thresholds

This section configures the temperature and time thresholds associated with the heating and cooling equipment.

You must configure the Equipment settings (page 10) before setting the thresholds. Only the applicable threshold settings will be displayed (i.e. if no air conditioner is configured, you will not see the options related to air conditioners).

## Allow Auto Heat/Cool

Enabling this option allows the user to select auto change-over as a system mode.

## Heat/Cool Min Delta

The minimum difference between the heat mode set temperature and the cool mode set temperature when the system mode is in auto change-over. The delta is adjustable from 2 to 10 °F (1.1 to 5.5 °C). The default value is 5 °F (2.8 °C).

### *To configure threshold settings:*

From the Home screen, press **MENU**.

Select **Settings** ►  
**Installation Settings**.

Select **Thresholds**.

Configure the temperature threshold settings.

## Compressor Settings

**Min Cycle Off Time** Configures the compressor off time between cycles. This ensures the compressor does not short cycle (which could affect the operating life of the system). This time is adjustable from 240–900 seconds.

**Min Outdoor Temp** Configures the minimum outside air temperature at which the compressor will be disabled. This performs two functions. It prevents the compressor from running when the outdoor temperature is too low, thus resulting in damage to the compressor. You can also set this value to determine when you want the auxiliary heat (if installed) to engage to help meet the set temperature. The temperature range is adjustable from 0 to 65 °F (–17.8 to 18.3 °C) or can be completely disabled. Note: You need an internet connection for this feature to operate properly.

## Aux Heat Settings

**Max Outdoor Temperature** Configures the maximum outdoor temperature threshold. Above this level, the auxiliary heat will not be activated. The temperature is adjustable from 0 to 80 °F (26.5 °C) in increments of 0.5°F (0.5°C). The default value is 70°F (21°C).

## Common Heat/Cool Settings

**Heat Differential Temp** The minimum difference between the current temperature and set temperature before the system calls for heat. A smaller difference means shorter cycle times, whereas a larger difference results in longer cycle times. The temperature range

is adjustable from 0 to 3 °F (-17.5 to 26.5 °C) in 0.5°F (0.5°C) increments.

**Heat Dissipation Time** The amount of time the fan will run after the heat set point has been reached and the call for heat has been turned off. Running the fan for a period of time allows for any heated air left in the ducts to circulate throughout the home. The time is adjustable from 0 to 900 seconds. The default value is 30 seconds.

**Cool Differential Temp** The minimum difference between the current temperature and set temperature before the system calls for cool. A smaller difference means shorter cycle times, whereas a larger difference results in longer cycle times. The temperature range is adjustable from 0 to 3 °F (0.3 to 1.7 °C) in 0.5°F (0.3°C) increments.

**Cool Dissipation Time** The amount of time the fan will run after the cool has been turned off. Running the fan for a period of time allows for any cooled air left in the ducts to circulate throughout the home. The time is adjustable from 0 to 900 seconds. The default value is 30 seconds.

## Advanced Settings

These options customize how long each stage will run before the next stage turns on. You may also program when a particular stage is turned on based on the temperature delta between the set temperature and the current temperature.

- **Reverse Staging** If enabled, the thermostat will cycle down from the higher stages so that as it approaches set point it will only be running in stage 1. The HVAC equipment will

start in stage 1. As the stage 1 temperature delta is exceeded, the second stage will engage. Once the equipment has brought the current temperature back to within the heat or cool differential setting, stage 2 will disengage and stage 1 will remain running until the set point is met.

- **Stage 2 Temp Delta** The minimum difference between the current temperature and the set temperature that will activate the auxiliary heat (regardless if the maximum run time of the previous stage was reached). Options are Auto (default) and 1 to 10 °F (0.6 to 5.6 °C).
- **Stage 1 Max Runtime** The maximum amount of time stage 1 will run before engaging the next stage. Options are Auto (default) and 10 to 120 minutes.
- **Comp to Aux Temp Delta** The maximum amount of time this stage will run before engaging the next stage. Options are Auto (default) and 1 to 10 °F (0.6 to 5.6 °C).
- **Comp to Aux Runtime** The minimum difference between the current temperature and the set temperature that will activate this stage (regardless if the maximum run time of the previous stage was reached). Options are Auto (default), Disabled, and 1 to 10 °F (0.6 to 5.6 °C).
- **Cool Min On Time** Sets the minimum equipment run time in cool mode: 1 to 20 min (default is 5 min).
- **Heat Min On Time** Sets the minimum equipment run time in heat mode: 1 to 20 min (default is 5 min).

## Temp Correction

Lets you program an offset between the real temperature at thermostat and the displayed temperature. If you find that the temperature where the thermostat is located does not represent the room temperature, change the offset to compensate for the difference. The correct temperature is adjustable from +/- 10°F in 0.5°F (0.3°C) increments.

## Installer Code

To prevent accidental modifications to the installation settings, you can enable a 4-digit installer code. This code is pre-programmed to 3262.

## Test Equipment

### **To test the equipment:**

From the Home screen, press **MENU**.

Select **Settings** ►  
**Installation Settings**.

Select **Test Equipment**.

Select **OK**.

Test the equipment connected to the thermostat by turning each component on and off.

These options let you test the wiring and connections of the devices connected to the thermostat by turning them on or off.

The equipment will turn off when you exit the menu.



*Warning: Compressor protection and minimum run-time features are not enforced while in this mode.*



## Reset HVAC Equipment Settings

You can quickly restore all HVAC equipment settings on the Smart Si thermostat back to their factory defaults. Any user setting (not related to the equipment installed) will remain unchanged.

If you need to reset the entire thermostat back to its original factory default settings, including user settings and registration, select **Reset All Settings** instead.

### *To reset the Smart Si thermostat:*

From the Home screen, press **MENU**.

Select **Settings** ► **Reset**.

Select **HVAC Equipment Settings**.

Select **Yes**.

## Performing a Hardware Reset

In rare circumstances, static electricity or power surges may interrupt the operation of the thermostat, forcing a hardware reset.

## Rebooting the Smart Si Thermostat

You can reboot the Smart Si thermostat by pressing the physical hardware reset button, located through an opening in the bottom left corner of the Smart Si thermostat. Rebooting will not alter programming or configuration options.

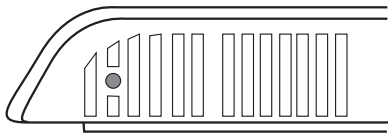

*Reset button*

## ***Configuring Reminders and Alerts***

### ***To configure Reminders and Alerts***

From the Home screen, press **MENU**.

Select **Reminders and Alerts**.

Configure the Reminder and Alert settings as required.

The Reminders and Alerts list displays the reminders and alerts described below.

### **HVAC Service**

The HVAC Service (maintenance) reminder generates an alert telling the homeowner that regularly scheduled maintenance is required.

This alert, along with technician contact information can be displayed on the screen. If homeowners register their thermostats, the reminders will be emailed to them and be displayed in the web portal.

You can set the Last Service date, turn the Reminder On or Off, and to set the Frequency of the maintenance interval in months.

### **Furnace Filter**

Generates an alert for cleaning or changing the filter. You can set the Last Filter Change date, turn the Reminder On or Off, and set the Frequency of the maintenance interval.

### **UV Lamp**

Sets the reminder period for cleaning or replacing the UV lamp. You can set the Last Lamp Change date, turn the Reminder On or Off, and set the Frequency of the maintenance interval.

## Alerts

The Smart Si thermostat can generate alerts if the temperature in the home goes over or under a pre-programmed level. This protects the home from damage due to freezing and/or excessive heat.

This alert, along with optional technician contact information will be displayed on the screen. If the homeowner registers the thermostat, the alert will be emailed to them and be displayed in the web portal.

**Low Temp Alert** Sets the temperature at which the thermostat will generate a Low Temperature Alert. The range can be:

- Off – no alert will be generated.
- Set temperature range of 35 to 68 °F (1.5 to 20 °C).

**High Temp Alert** Sets the temperature at which the thermostat will generate a High Temperature Alert. The range can be:

- Off – no alert will be generated.
- Set temperature range of 60 to 104 °F (15.5 to 40 °C).

### Display Alerts on Thermostat

Select No if you do not want any of the alerts to be displayed on the Smart Si thermostat screen. Alerts will continue to be displayed on the web portal and sent via email.

### Enable Heating/Cooling Alerts

Select No to disable alerts for heat/cool error conditions. If disabled, alerts indicating that the system failed to heat or cool will not be appear in the screen, web portal, or emails.

## ***List of Alerts***

Below is a complete list of alerts. Depending on your configuration, some of these may not apply.

Furnace Air Filter	Furnace filter needs to be cleaned or changed.
UV Lamp	UV lamp needs to be changed.
Low Temp Alert	Temperature in the home is too low.
High Temp Alert	Temperature in the home is too high.
Heat Not Responding	The system has failed to heat the home.
Cool Not Responding	The system has failed to cool the home.
Maintenance Reminder	HVAC system due for regular maintenance.
Auxiliary Heat Run Time	Auxiliary heat source is running too often.
Auxiliary Outdoor Temperature	Your Smart Si thermostat auxiliary heat has been called to run when the outdoor temperature exceeds the programmed set point.

## 3-YEAR LIMITED WARRANTY

ecobee warrants that for a period of three (3) years from the date of purchase by the consumer ("Customer"), the ecobee Smart Si thermostat (the "Product") shall be free of defects in materials and workmanship under normal use and service. During the warranty period, ecobee shall, at its option, repair or replace any defective Products, at no charge. Any replacement and/or repaired device are warranted for the remainder of the original warranty or ninety (90) days, whichever is longer.

If the product is defective, call Customer Service at 1-877-932-6233. ecobee will make the determination whether a replacement product can be sent to you or whether the product should be returned to the following address: ecobee Customer Service, 477 Richmond Street West, #210, Toronto, ON M5V 3E7, Canada. In the event of a failure of a Product, Customer may:

(a) if Customer did not purchase the Product directly from ecobee, contact the third party contractor from whom the Product was purchased to obtain an equivalent replacement product, provided the contractor determines that the returned Product is defective and Customer is otherwise eligible to receive a replacement product;

(b) contact ecobee directly for service assistance at 1-877-932-6233 and ecobee will make the determination whether an advance equivalent replacement Product can be sent to Customer with return shipping supplies (in which case a hold shall be put on Customer's credit card for the value of the replacement Product until ecobee has received the defective Product). Product should be returned to the following address: ecobee Customer Service, 477 Richmond Street West, #210, Toronto, ON M5V 3E7, Canada. If the returned Product is found by ecobee to be defective and Customer is otherwise eligible to receive a replacement product, no amount shall be charged to Customer's credit card; or

(c) ship the defective Product directly to ecobee, in which case Customer shall contact ecobee directly at 1-877-932-6233, so ecobee can make the required shipping arrangements. Upon receipt of the defective Product, ecobee will ship an equivalent replacement product to Customer, provided the returned Product is found by ecobee to be defective and Customer is otherwise eligible to receive a replacement product.

This warranty does not cover removal or reinstallation costs and shall not apply if the damages were found to be caused by something other than defects in materials or workmanship, including without limitation, if the Product:

- was operated/stored in abnormal use or maintenance conditions;
- is repaired, modified or altered, unless ecobee expressly
- authorizes such repair, modification or alteration in writing;
- was subject to abuse, neglect, electrical fault, improper handling, accident or acts

of nature;

- was not installed by a licensed Heating Ventilating and Air Conditioning (HVAC) contractor; or
- was installed improperly.

ecobee's sole responsibility shall be to repair or replace the Product within the terms stated above. ECOBEE SHALL NOT BE LIABLE FOR ANY LOSS OR DAMAGE OF ANY KIND, INCLUDING ANY SPECIAL, INCIDENTAL OR CONSEQUENTIAL DAMAGES RESULTING, DIRECTLY OR INDIRECTLY, FROM ANY BREACH OF ANY WARRANTY, EXPRESS OR IMPLIED, OR ANY OTHER FAILURE OF THIS PRODUCT. Some US states and Canadian provinces do not allow the exclusion or limitation of incidental or consequential damages, so the above limitation or exclusion may not apply to you.

ecobee's responsibility for malfunctions and defects in materials and workmanship is limited to repair and replacement as set forth in this warranty statement. All express and implied warranties for the product, including but not limited to any implied warranties and conditions of merchantability and fitness for a particular purpose, are limited to the three-year duration of this limited warranty. No warranties, whether express or implied, will apply after the limited warranty period has expired. Some US states and Canadian provinces do not allow limitations on how long an implied warranty lasts, so this limitation may not apply.

ecobee neither assumes responsibility for nor authorizes any other person purporting to act on its behalf to modify or to change this warranty, nor to assume for it any other warranty or liability concerning this product.

This warranty gives you specific rights, and you may also have other rights which vary from jurisdiction to jurisdiction. If you have any questions regarding this warranty, please write ecobee Customer Service, 477 Richmond Street West, #210, Toronto, Ontario M5V 3E7, Canada.



©2012 ecobee  
477 Richmond Street West | Suite 210  
Toronto | Ontario | M5V 3E7 | Canada  
Toll free 1.877.932.6233  
[www.ecobee.com](http://www.ecobee.com)

EB-SmartSiIM-01-rev1

