

Service Manual

Air Conditioner

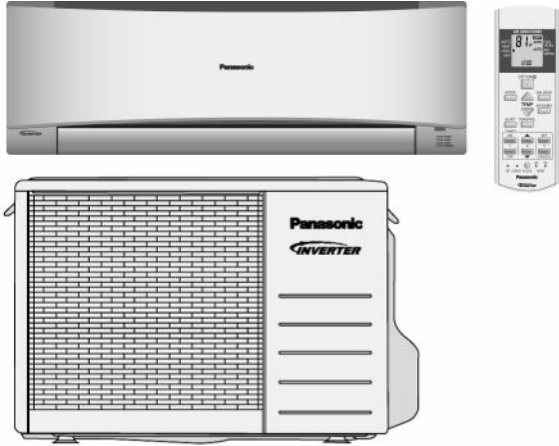

Indoor Unit
CS-E9NKUAW
CS-E12NKUAW

Outdoor Unit
CU-E9NKUA
CU-E12NKUA

Please file and use this manual together with the service manual for Model No. CU-2E18NBU, Order No. PHAAM111120A1.

WARNING

This service information is designed for experienced repair technicians only and is not designed for use by the general public. It does not contain warnings or cautions to advise non-technical individuals of potential dangers in attempting to service a product. Products powered by electricity should be serviced or repaired only by experienced professional technicians. Any attempt to service or repair the products dealt with in this service information by anyone else could result in serious injury or death.

PRECAUTION OF LOW TEMPERATURE

In order to avoid frostbite, be assured of no refrigerant leakage during the installation or repairing of refrigerant circuit.

TABLE OF CONTENTS

1. Safety Precautions	3	8.1 Indoor Unit.....	14
2. Specification	5	8.2 Outdoor Unit.....	15
3. Features	8	9. Electronic Circuit Diagram	16
4. Location of Controls and Components	9	9.1 Indoor Unit.....	16
4.1 Indoor Unit.....	9	9.2 Outdoor Unit.....	17
4.2 Outdoor Unit.....	9	10. Printed Circuit Board	18
4.3 Remote Control.....	9	10.1 Indoor Unit.....	18
5. Dimensions	10	10.2 Outdoor Unit.....	20
5.1 Indoor Unit.....	10	11. Installation Instruction	21
5.2 Outdoor Unit.....	11	11.1 Select the Best Location.....	21
6. Refrigeration Cycle Diagram	12	11.2 Indoor Unit.....	22
7. Block Diagram	13	11.3 Outdoor Unit.....	26
8. Wiring Connection Diagram	14	12. Operation Control	29
		12.1 Basic Function.....	29
		12.2 Indoor Fan Motor Operation.....	30



Panasonic®

© Panasonic HA Air-Conditioning (M) Sdn. Bhd. 2011.
 Unauthorized copying and distribution is a violation of law.

12.3	Outdoor Fan Motor Operation	31
12.4	Airflow Direction.....	31
12.5	Quiet Operation (Cooling Mode/Cooling Area of Dry Mode).....	32
12.6	Quiet Operation (Heating)	32
12.7	Powerful Mode Operation.....	33
12.8	Timer Control.....	33
12.9	Auto Restart Control	33
12.10	Indication Panel.....	34
13.	Operation Control (For Multi Split Connection).....	35
13.1	Cooling operation	35
13.2	Soft Dry Operation.....	35
13.3	Heating Operation	35
13.4	Automatic Operation.....	36
13.5	Indoor Fan Motor Operation	36
13.6	Powerful Mode Operation.....	36
13.7	Auto restart control	36
13.8	Indication Panel.....	36
14.	Protection Control.....	37
14.1	Protection Control For All Operations.....	37
14.2	Protection Control For Cooling & Soft Dry Operation.....	38
15.	Servicing Mode	41
15.1	Auto Off/On Button	41
15.2	Remote Control Button.....	42
16.	Troubleshooting Guide.....	43
16.1	Refrigeration Cycle System.....	43
16.2	Breakdown Self Diagnosis Function.....	45
16.3	Error Code Table	46
16.4	Self-diagnosis Method.....	48
17.	Disassembly and Assembly Instructions	75
17.1	Indoor Electronic Controllers, Cross Flow Fan and Indoor Fan Motor Removal Procedures	75
18.	Technical Data	79
18.1	Operation Characteristics	79
19.	Exploded View and Replacement Parts List	87
19.1	Indoor Unit.....	87
19.2	Outdoor Unit	89

1. Safety Precautions





- Read the following “SAFETY PRECAUTIONS” carefully before perform any servicing.
- Electrical work must be installed or serviced by a licensed electrician. Be sure to use the correct rating of the power plug and main circuit for the model installed.
- The caution items stated here must be followed because these important contents are related to safety. The meaning of each indication used is as below. Incorrect installation or servicing due to ignoring of the instruction will cause harm or damage, and the seriousness is classified by the following indications.

 WARNING	This indication shows the possibility of causing death or serious injury
 CAUTION	This indication shows the possibility of causing injury or damage to properties.

- The items to be followed are classified by the symbols:

	This symbol denotes item that is PROHIBITED from doing.
---	---

- Carry out test run to confirm that no abnormality occurs after the servicing. Then, explain to user the operation, care and maintenance as stated in instructions. Please remind the customer to keep the operating instructions for future reference.

 WARNING	
1. Do not modify the machine, part, material during repairing service.	
2. If wiring unit is supplied as repairing part, do not repair or connect the wire even only partial wire break. Exchange the whole wiring unit.	
3. Do not wrench the fasten terminal. Pull it out or insert it straightly.	
4. Engage authorized dealer or specialist for installation and servicing. If installation of servicing done by the user is defective, it will cause water leakage, electrical shock or fire.	
5. Install according to this installation instructions strictly. If installation is defective, it will cause water leakage, electric shock or fire.	
6. Use the attached accessories parts and specified parts for installation and servicing. Otherwise, it will cause the set to fall, water leakage, fire or electrical shock.	
7. Install at a strong and firm location which is able to withstand the set's weight. If the strength is not enough or installation is not properly done, the set will drop and cause injury.	
8. For electrical work, follow the local national wiring standard, regulation and the installation instruction. An independent circuit and single outlet must be used. If electrical circuit capacity is not enough or defect found in electrical work, it will cause electrical shock or fire.	
9. This equipment is strongly recommended to be installed with Earth Leakage Circuit Breaker (ELCB) or Residual Current Device (RCD). Otherwise, it may cause electrical shock and fire in case equipment breakdown or insulation breakdown.	
10. Do not use joint cable for indoor/outdoor connection cable. Use the specified indoor/outdoor connection cable, refer to installation instruction CONNECT THE CABLE TO THE INDOOR UNIT and connect tightly for indoor/outdoor connection. Clamp the cable so that no external force will be acted on the terminal. If connecting or fixing is not perfect, it will cause heat up or fire at the connection.	
11. Wire routing must be properly arranged so that control board cover is fixed properly. If control board cover is not fixed perfectly, it will cause heat-up or fire at the connection point of terminal, fire or electrical shock.	
12. When install or relocate air conditioner, do not let any substance other than the specified refrigerant, eg. air etc. mix into refrigeration cycle (piping). (Mixing of air etc. will cause abnormal high pressure in refrigeration cycle and result in explosion, injury etc.).	
13. Do not install outdoor unit near handrail of veranda. When installing air-conditioner unit at veranda of high rise building, child may climb up to outdoor unit and cross over the handrail and causing accident.	
14. This equipment must be properly earthed. Earth line must not be connected to gas pipe, water pipe, earth of lightning rod and telephone. Otherwise, it may cause electrical shock in case equipment breakdown or insulation breakdown.	
15. Keep away from small children, the thin film may cling to nose and mouth and prevent breathing.	
16. Do not use unspecified cord, modified cord, joint cord or extension cord for power supply cord. Do not share the single outlet with other electrical appliances. Poor contact, poor insulation or over current will cause electrical shock or fire.	
17. Tighten the flare nut with torque wrench according to specified method. If the flare nut is over-tightened, after a long period, the flare may break and cause refrigerant gas leakage.	
18. For R410A models, when connecting the piping, do not use any existing (R22) pipes and flares nuts. Using such same may cause abnormally high pressure in the refrigeration cycle (piping), and possibly result in explosion and injury. In case of using existing (R22) pipes during installation of R410A models, must carry out pump down properly to collect back the refrigerant and oil before installation new unit. Thickness of copper pipes used with R410A must be more than 1/64". Never use copper pipes thinner than 1/64". It is desirable that the amount of residual oil is less than 0.0014 oz/32.8ft.	

19. During installation, install the refrigerant piping properly before run the compressor. (Operation of compressor without fixing refrigeration piping and valves at opened condition will cause suck-in of air, abnormal high pressure in refrigeration cycle and result in explosion, injury etc.).	
20. During pump down operation, stop the compressor before remove the refrigeration piping. (Removal of refrigeration piping while compressor is operating and valves are opened condition will cause suck-in of air, abnormal high pressure in refrigeration cycle and result in explosion, injury etc.).	
21. After completion of installation or service, confirm there is no leakage of refrigerant gas. It may generate toxic gas when the refrigerant contacts with fire.	
22. Ventilate if there is refrigerant gas leakage during operation. It may cause toxic gas when the refrigerant contacts with fire.	
23. Do not insert your fingers or other objects into the unit, high speed rotating fan may cause injury.	⊘
24. Must not use other parts except original parts describe in catalog and manual.	
25. Using of refrigerant other than the specified type may cause product damage, burst and injury etc.	

 CAUTION	
1. Do not install the unit at place where leakage of flammable gas may occur. In case gas leaks and accumulates at surrounding of the unit, it may cause fire.	⊘
2. Carry out drainage piping as mentioned in installation instructions. If drainage is not perfect, water may enter the room and damage the furniture.	
3. Tighten the flare nut with torque wrench according to specified method. If the flare nut is over-tightened, after a long period, the flare may break and cause refrigerant gas leakage.	
4. Do not touch outdoor unit air inlet and aluminium fin. It may cause injury.	⊘
5. Select an installation location which is easy for maintenance.	
6. Pb free solder has a higher melting point than standard solder; typically the melting point is 50°F – 70°F (30°C – 40°C) higher. Please use a high temperature solder iron. In case of the soldering iron with temperature control, please set it to 700 ± 20°F (370 ± 10°C). Pb free solder will tend to splash when heated too high (about 1100°F / 600°C).	
7. Power supply connection to the air conditioner. Connect the power supply cord of the air conditioner to the mains using one of the following methods. Power supply point shall be the place where there is ease for access for the power disconnection in case of emergency. In some countries, permanent connection of this room air conditioner to the power supply is prohibited. i. Power supply connection to the receptacle using a power plug. Use an approved 15/16A (1.0 ~ 1.75HP) or 16A (2.0HP) or 20A (2.5HP) power plug with earth pin for the connection to the socket. ii. Power supply connection to a circuit breaker for the permanent connection. Use an approved 16A (1.0 ~ 2.0HP) or 20A (2.5HP) circuit breaker for the permanent connection. It must be a double pole switch with a minimum 3.0 mm contact gap.	
8. Do not release refrigerant during piping work for installation, servicing, reinstallation and during repairing a refrigerant parts. Take care of the liquid refrigerant, it may cause frostbite.	⊘
9. Installation or servicing work: It may need two people to carry out the installation or servicing work.	
10. Do not install this appliance in a laundry room or other location where water may drip from the ceiling, etc.	⊘
11. Do not sit or step on the unit, you may fall down accidentally.	⊘
12. Do not touch the sharp aluminium fins or edges of metal parts. If you are required to handle sharp parts during installation or servicing, please wear hand glove. Sharp parts may cause injury.	⊘

2. Specification

Model		Indoor	CS-E9NKUAW						CS-E12NKUAW						
		Outdoor	CU-E9NKUA						CU-E12NKUA						
Performance Test Condition			ARI						ARI						
Power Supply		Phase, Hz	Single, 60						Single, 60						
		V	208			230			208			230			
			Min.	Mid.	Max.	Min.	Mid.	Max.	Min.	Mid.	Max.	Min.	Mid.	Max.	
Cooling	Capacity	kW	1.20	2.49	3.00	1.20	2.49	3.00	1.20	3.51	3.90	1.20	3.51	3.90	
		BTU/h	4100	8500	10200	4100	8500	10200	4100	12000	13300	4100	12000	13300	
	Running Current	A	-	3.5	-	-	3.1	-	-	5.2	-	-	4.7	-	
	Input Power	W	250	650	850	250	650	850	250	1.00k	1.15k	250	1.00k	1.15k	
	EER	W/W	4.80	3.83	3.53	4.80	3.83	3.53	4.80	3.51	3.39	4.80	3.51	3.39	
		Btu/hW	16.40	13.05	12.00	16.40	13.05	12.00	16.40	12.00	11.55	16.40	12.00	11.55	
	Power Factor	%	-	89	-	-	91	-	-	92	-	-	93	-	
	Indoor Noise (H / L / QLo)	dB-A	40 / 25 / 20			40 / 25 / 20			43 / 28 / 20			43 / 28 / 20			
		Power Level dB	56 / - / -			56 / - / -			59 / - / -			59 / - / -			
	Outdoor Noise (H / L / QLo)	dB-A	47 / - / -			47 / - / -			48 / - / -			48 / - / -			
Power Level dB		62 / - / -			62 / - / -			63 / - / -			63 / - / -				
Heating	Capacity	kW	1.20	3.27	4.14	1.20	3.27	4.14	1.20	4.05	4.77	1.20	4.05	4.77	
		BTU/h	4100	11200	14100	4100	11200	14100	4100	13800	16300	4100	13800	16300	
	Running Current	A	-	6.1	-	-	5.4	-	-	6.5	-	-	5.8	-	
	Input Power	W	200	1.15k	1.50k	200	1.15k	1.50k	200	1.30k	1.71k	200	1.30K	1.71k	
	COP	W/W	6.00	2.84	2.76	6.00	2.84	2.76	6.00	3.12	2.79	6.00	3.12	2.79	
		Btu/hW	20.50	9.70	9.40	20.50	9.70	9.40	20.50	10.60	9.50	20.50	10.60	9.50	
	Power Factor	%	-	91	-	-	93	-	-	96	-	-	97	-	
	Indoor Noise (H / L / QLo)	dB-A	42 / 29 / 26			42 / 29 / 26			44 / 35 / 32			44 / 35 / 32			
		Power Level dB	58 / - / -			58 / - / -			60 / - / -			60 / - / -			
	Outdoor Noise (H / L / QLo)	dB-A	46 / - / -			48 / - / -			49 / - / -			49 / - / -			
Power Level dB		63 / - / -			63 / - / -			64 / - / -			64 / - / -				
Max Current (A) / Max Input Power (W)			7.0 / 1.57k						7.8 / 1.71k						
Starting Current (A)			6.1						6.5						
Min Circuit Ampacity			15.0						15.0						
Max. Current Protection			15.0						15.0						
SEER / HSPF			21.00 / 10.50						20.00 / 10.00						
Compressor	Type	Hermetic Motor						Hermetic Motor							
	Motor Type	Brushless (4 poles)						Brushless (4 poles)							
	Output Power	W	700						700						
Indoor Fan	Type	Cross-flow fan						Cross-flow fan							
	Material	ASG20K1						ASG20K1							
	Motor Type	Transistor (8 poles)						Transistor (8 poles)							
	Input Power	W	47.0 - 47.0						47.0 - 47.0						
	Output Power	W	40						40						
	Speed	QLo	rpm	Cooling : 620 Heating : 750						Cooling : 630 Heating : 970					
		Lo	rpm	Cooling : 720 Heating : 850						Cooling : 790 Heating : 1070					
		Me	rpm	Cooling : 930 Heating : 1070						Cooling : 1030 Heating : 1250					
		Hi	rpm	Cooling : 1150 Heating : 1300						Cooling : 1270 Heating : 1430					
		SHi	rpm	Cooling : 1250 Heating : 1390						Cooling : 1400 Heating : 1500					

Outdoor Fan	Type		Propeller		Propeller	
	Material		PP		PP	
	Motor Type		DC (8 poles)		DC (8 poles)	
	Input Power		W	-	-	
	Output Power		W	40	40	
	Speed	Hi	rpm	C: 830 H: 780		C: 830 H: 780
Moisture Removal		L/h (Pt/h)	0.6 (1.3)		1.2 (2.5)	
Indoor Airflow	QLo	m ³ /min (ft ³ /min)	Cooling : 5.42 (191) Heating : 6.49 (229)		Cooling : 5.30 (187) Heating : 8.75 (309)	
	Lo	m ³ /min (ft ³ /min)	Cooling : 6.51 (230) Heating : 7.53 (266)		Cooling : 6.98 (246) Heating : 9.78 (345)	
	Me	m ³ /min (ft ³ /min)	Cooling : 8.80 (311) Heating : 9.81 (346)		Cooling : 9.49 (335) Heating : 11.64 (411)	
	Hi	m ³ /min (ft ³ /min)	Cooling : 11.2 (395) Heating : 12.2 (430)		Cooling : 12.0 (425) Heating : 13.5 (475)	
	SHi	m ³ /min (ft ³ /min)	Cooling : 12.29 (434) Heating : 13.13 (464)		Cooling : 13.36 (472) Heating : 14.23 (502)	
Outdoor Airflow	Hi	m ³ /min (ft ³ /min)	Cooling : 31.0 (1095) Heating : 31.0 (1095)		Cooling : 31.0 (1095) Heating : 31.0 (1095)	
Refrigeration Cycle	Control Device		Capillary Tube		Capillary Tube	
	Refrigerant Oil	cm ³	FV50S (320)		FV50S (320)	
	Refrigerant Type	g (oz)	R410A, 965 (34.1)		R410A, 980 (34.6)	
Dimension	Height(I/D / O/D)	mm (inch)	290 (11-7/16) / 540 (21-9/32)		290 (11-7/16) / 540 (21-9/32)	
	Width(I/D / O/D)	mm (inch)	870 (34-9/32) / 780 (30-23/32)		870 (34-9/32) / 780 (30-23/32)	
	Depth(I/D / O/D)	mm (inch)	204 (8-1/16) / 289 (11-13/32)		204 (8-1/16) / 289 (11-13/32)	
Weight	Net(I/D / O/D)	kg (lb)	9 (20)	37 (82)	9 (20)	37 (82)
Piping	Pipe Diameter (Liquid / Gas)	mm (inch)	6.35 (1/4) / 9.52 (3/8)		6.35 (1/4) / 12.70 (1/2)	
	Standard length	m (ft)	7.5 (24.6)		7.5 (24.6)	
	Length range (min – max)	m (ft)	3 (9.8) ~ 20 (65.6)		3 (9.8) ~ 20 (65.6)	
	I/D & O/D Height different	m (ft)	15 (49.2)		15 (49.2)	
	Additional Gas Amount	g/m (oz/ft)	20 (0.2)		20 (0.2)	
	Length for Additional Gas	m (ft)	7.5 (24.6)		7.5 (24.6)	
Drain Hose	Inner Diameter	mm (inch)	16.7 (5/8)		16.7 (5/8)	
	Length	mm (inch)	650 (25-5/8)		650 (25-5/8)	
Indoor Heat Exchanger	Fin Material		Aluminium (Pre Coat)		Aluminium (Pre Coat)	
	Fin Type		Slit Fin		Slit Fin	
	Row x Stage x FPI		2 x 15 x 21		2 x 15 x 21	
	Size (W x H x L)	inch	1 x 12-3/8 x 24		1 x 12-3/8 x 24	
Outdoor Heat Exchanger	Fin Material		Aluminium (Blue coated)		Aluminium (Blue coated)	
	Fin Type		Corrugate Fin		Corrugate Fin	
	Row x Stage x FPI		2 x 24 x 17		2 x 24 x 17	
	Size (W x H x L)	inch	1-3/8 x 19-7/18 x 28-1/8 26-7/8		1-3/8 x 19-7/18 x 28-1/8 26-7/8	
Air Filter	Material		Polypropelene		Polypropelene	
	Type		One-touch		One-touch	
Power Supply			Outdoor		Outdoor	
Power Supply Cord		A	-		-	
Thermostat			-		-	
Protection Device			-		-	

		DRY BULB	WET BULB	DRY BULB	WET BULB
Indoor Operation Range (Cooling)	Maximum	89.6	73.4	89.6	73.4
	Minimum	60.8	51.8	60.8	51.8
Outdoor Operation Range (Cooling)	Maximum	109.4	78.8	109.4	78.8
	Minimum	5.0	-	5.0	-
Indoor Operation Range (Heating)	Maximum	86.0	-	86.0	-
	Minimum	60.8	-	60.8	-
Outdoor Operation Range (Heating)	Maximum	75.2	64.4	75.2	64.4
	Minimum	5.0	3.2	5.0	3.2

1. Cooling capacities are based on indoor temperature of 27°C DRY BULB (80.6°F DRY BULB), 19.0°C WET BULB (66°F WET BULB) and outdoor air temperature of 35°C DRY BULB (95°F DRY BULB), 24°C WET BULB (75.2°F WET BULB)
2. Heating capacities are based on indoor temperature of 20°C Dry Bulb (68°F Dry Bulb) and outdoor air temperature of 7°C Dry Bulb (44.6°F Dry Bulb), 6°C Wet Bulb (42.8°F Wet Bulb)
3. Specifications are subjected to change without prior notice for further improvement.

3. Features

- **Inverter Technology**
 - Wider output power range
 - Energy saving
 - Quick Cooling
 - More precise temperature control
- **Environment Protection**
 - Non-ozone depletion substances refrigerant (R410A)
- **Long Installation Piping**
 - CS/CU-E9/12NK, long piping up to 20 meters
- **Easy to use remote control**
- **Quality Improvement**
 - Random auto restart after power failure for safety restart operation
 - Gas leakage protection
 - Prevent compressor reverse cycle
 - Inner protector to protect Compressor
 - Noise prevention during soft dry operation
- **Operation Improvement**
 - Quiet mode to reduce the indoor unit operating sound
 - Powerful mode to reach the desired room temperature quickly
- **Serviceability Improvement**
 - Breakdown Self Diagnosis function

4. Location of Controls and Components

4.1 Indoor Unit

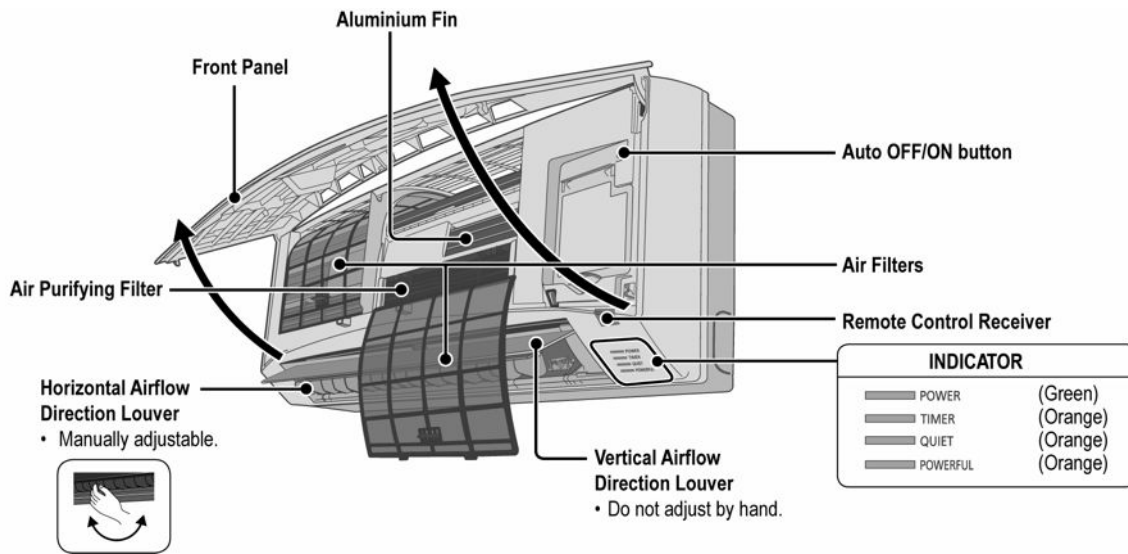

4.2 Outdoor Unit

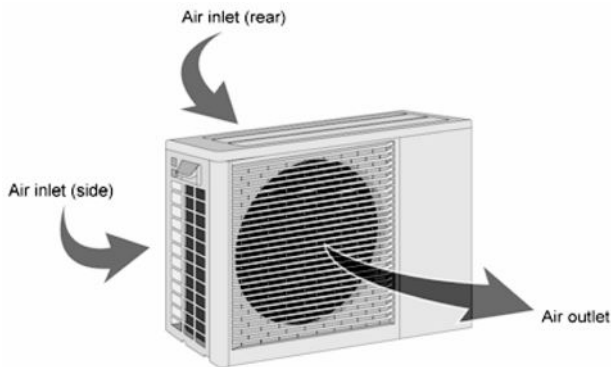

4.3 Remote Control

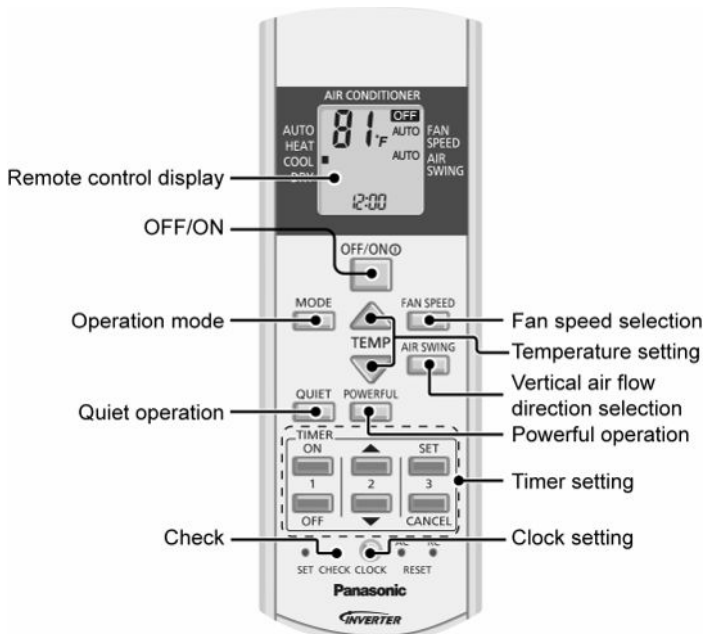

5. Dimensions

5.1 Indoor Unit

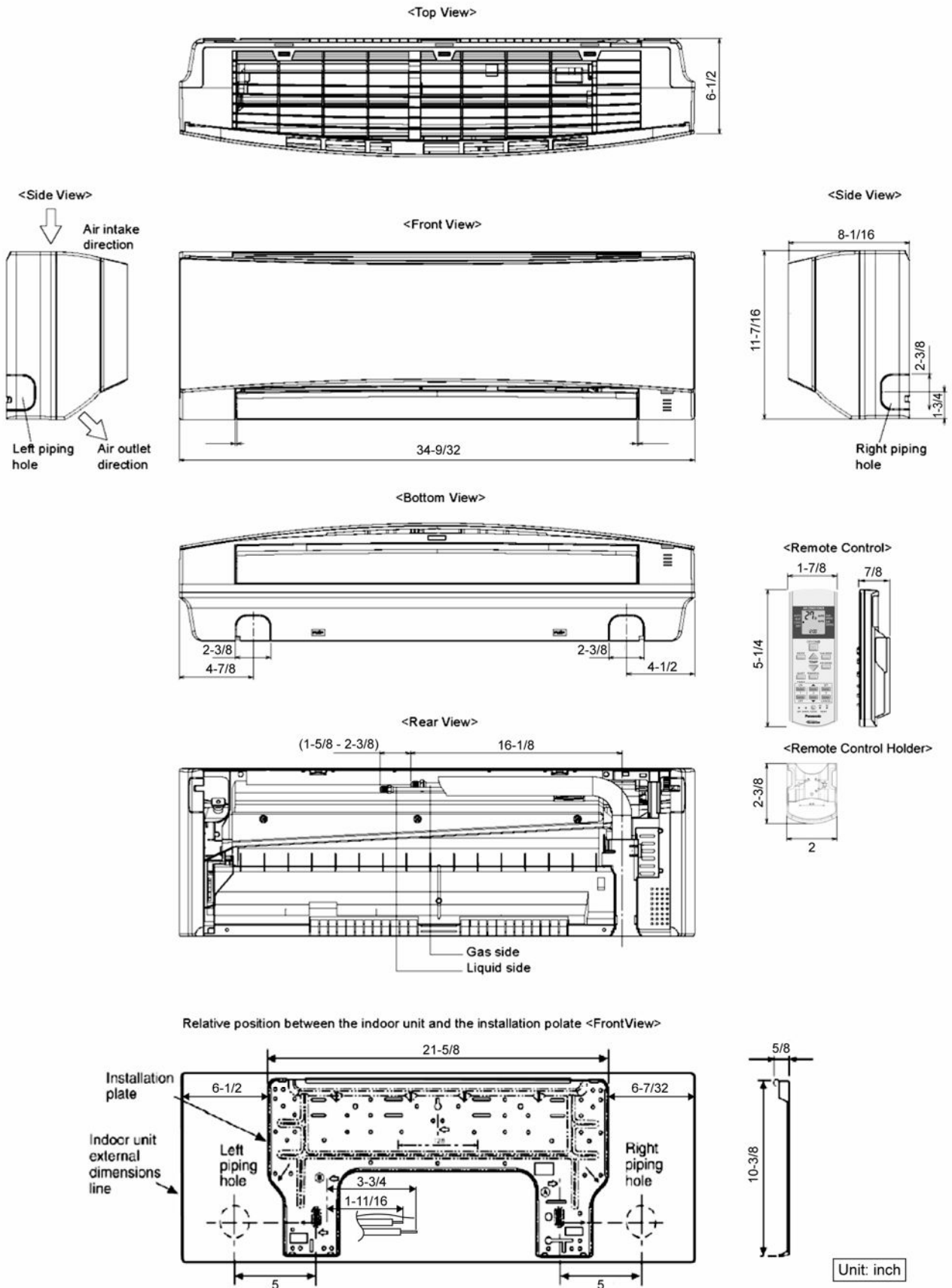

5.2 Outdoor Unit

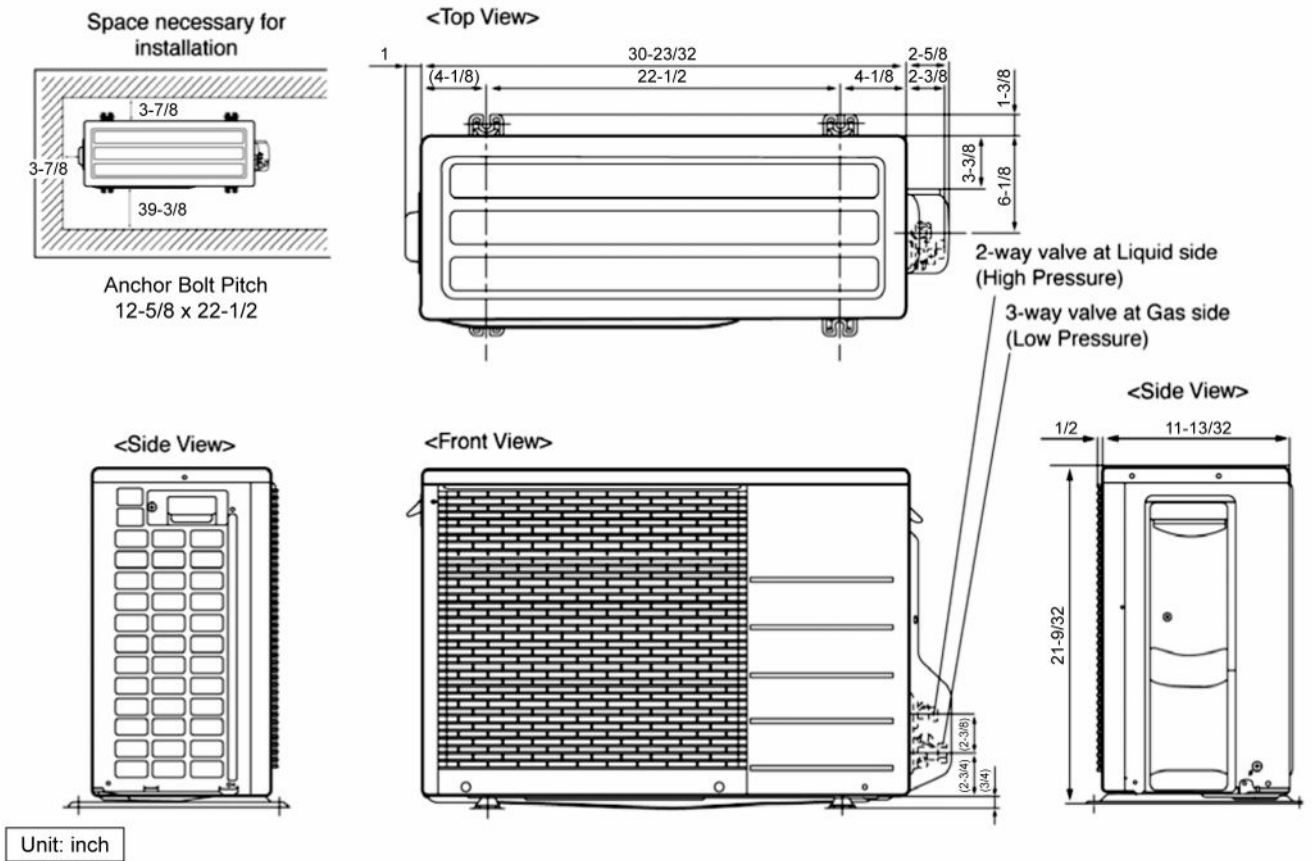

6. Refrigeration Cycle Diagram

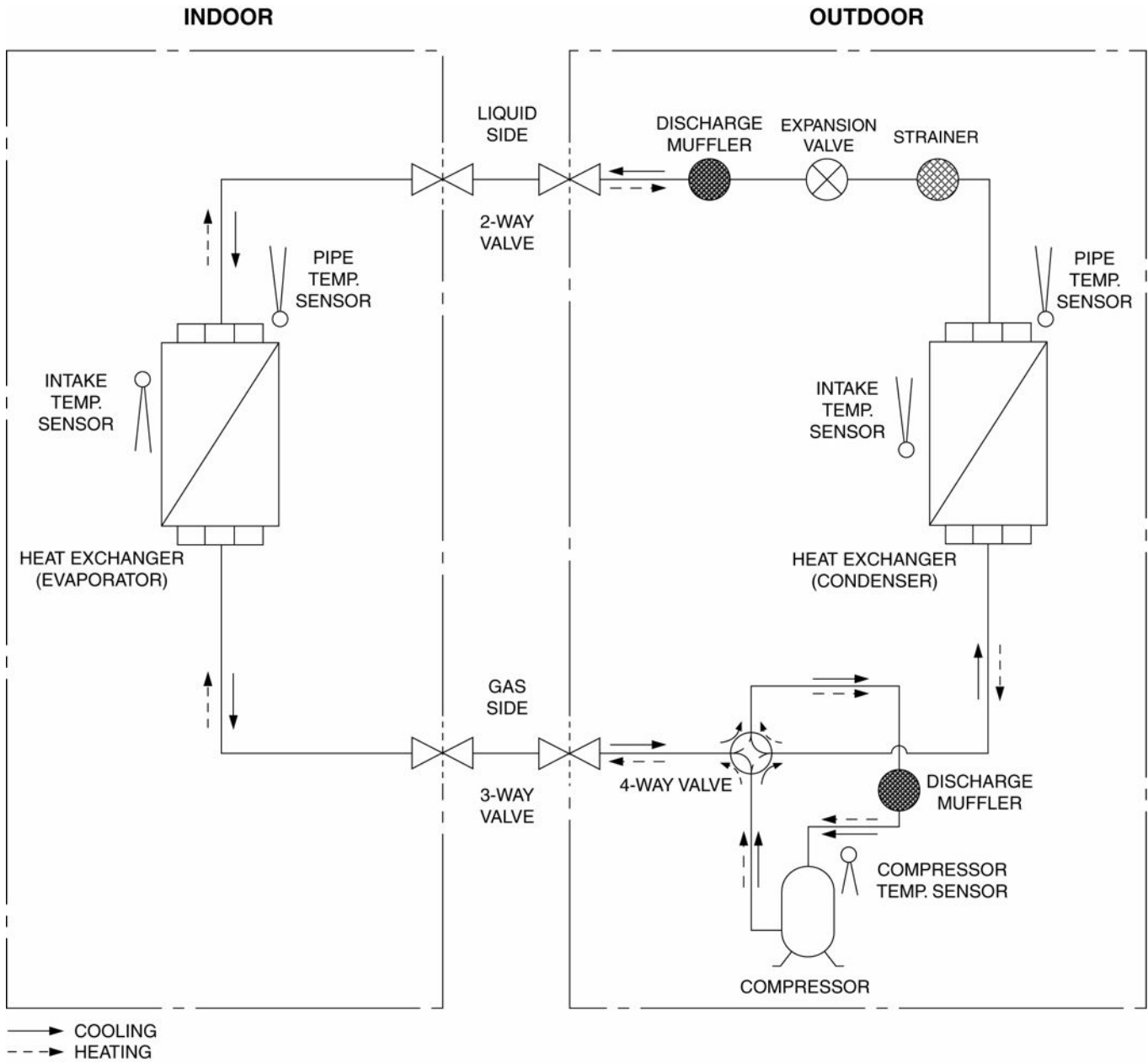

7. Block Diagram

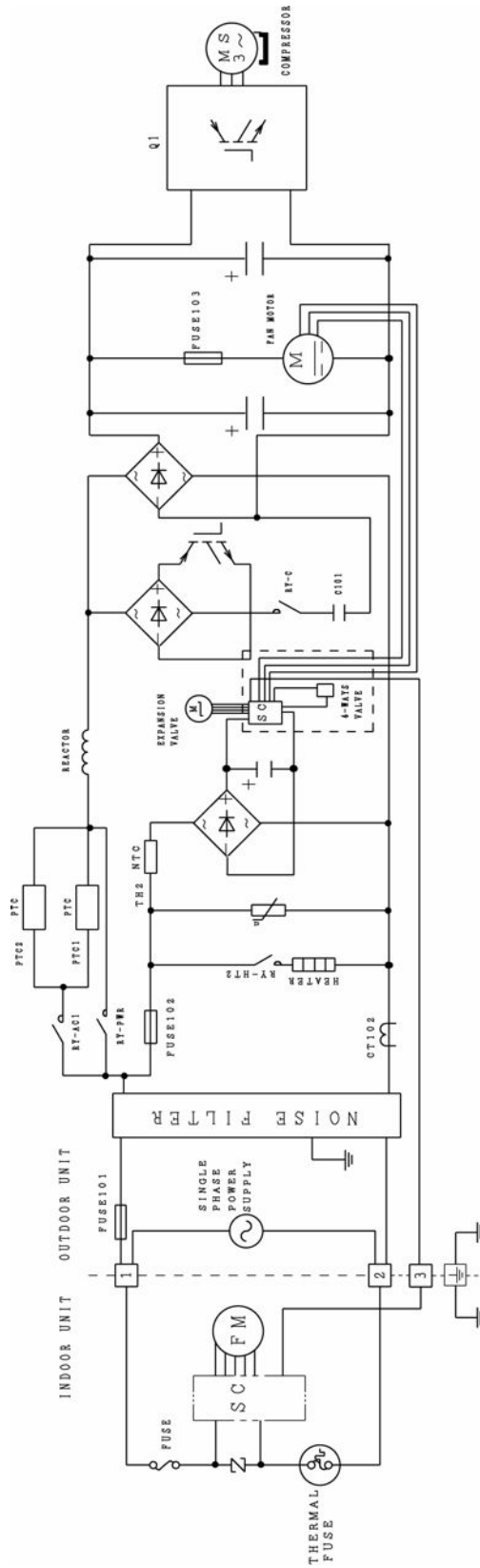

8. Wiring Connection Diagram

8.1 Indoor Unit

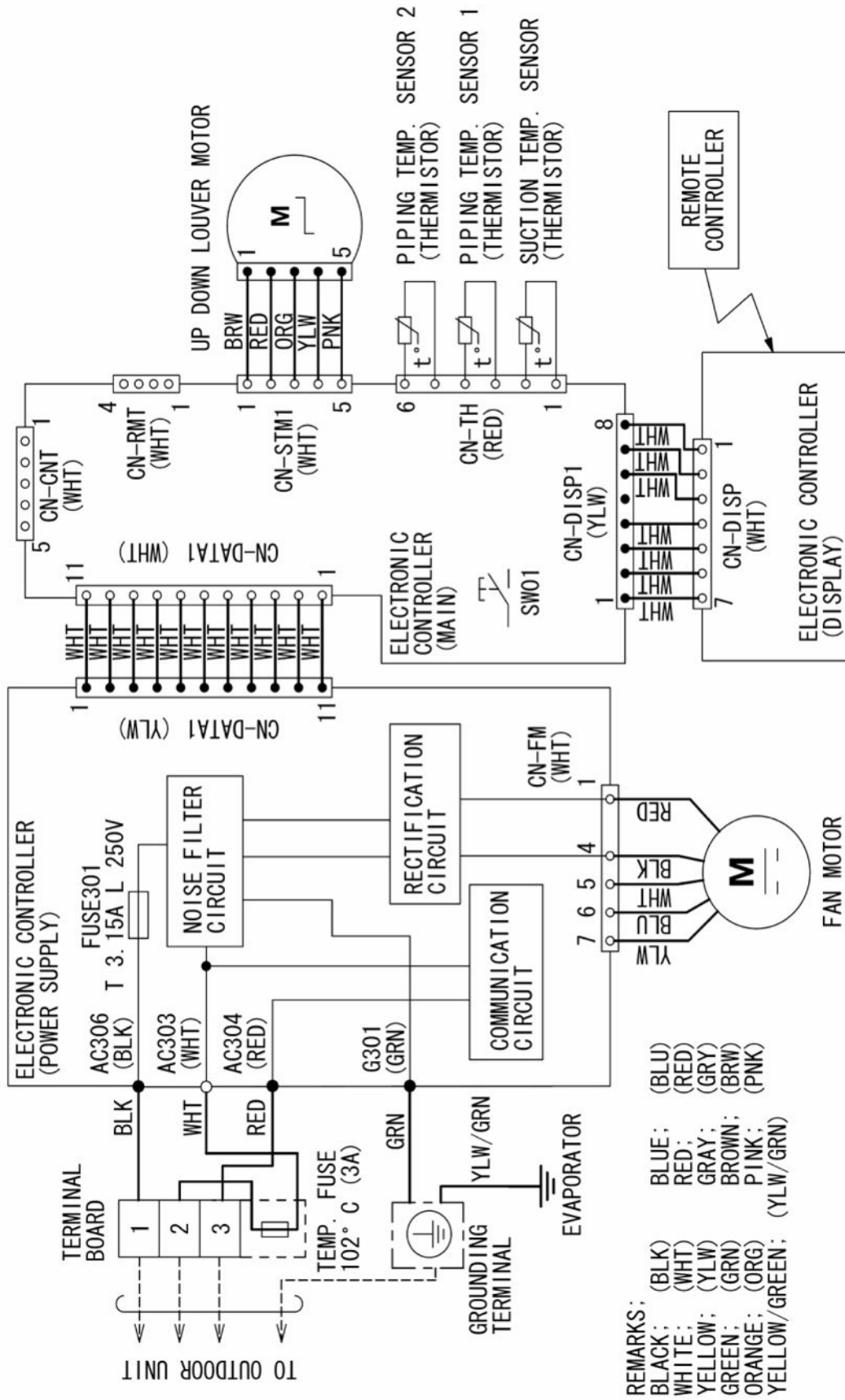

8.2 Outdoor Unit

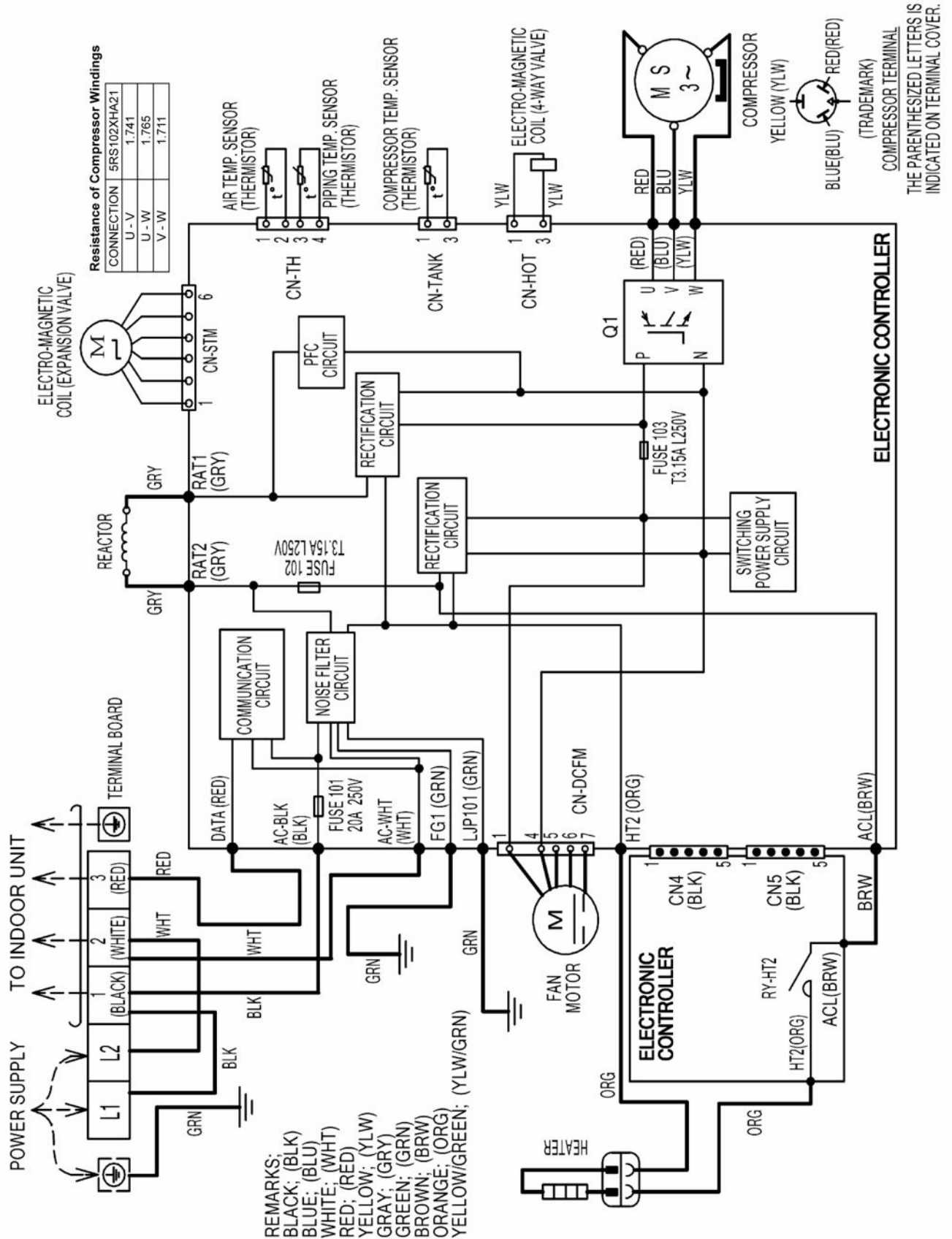

9. Electronic Circuit Diagram

9.1 Indoor Unit

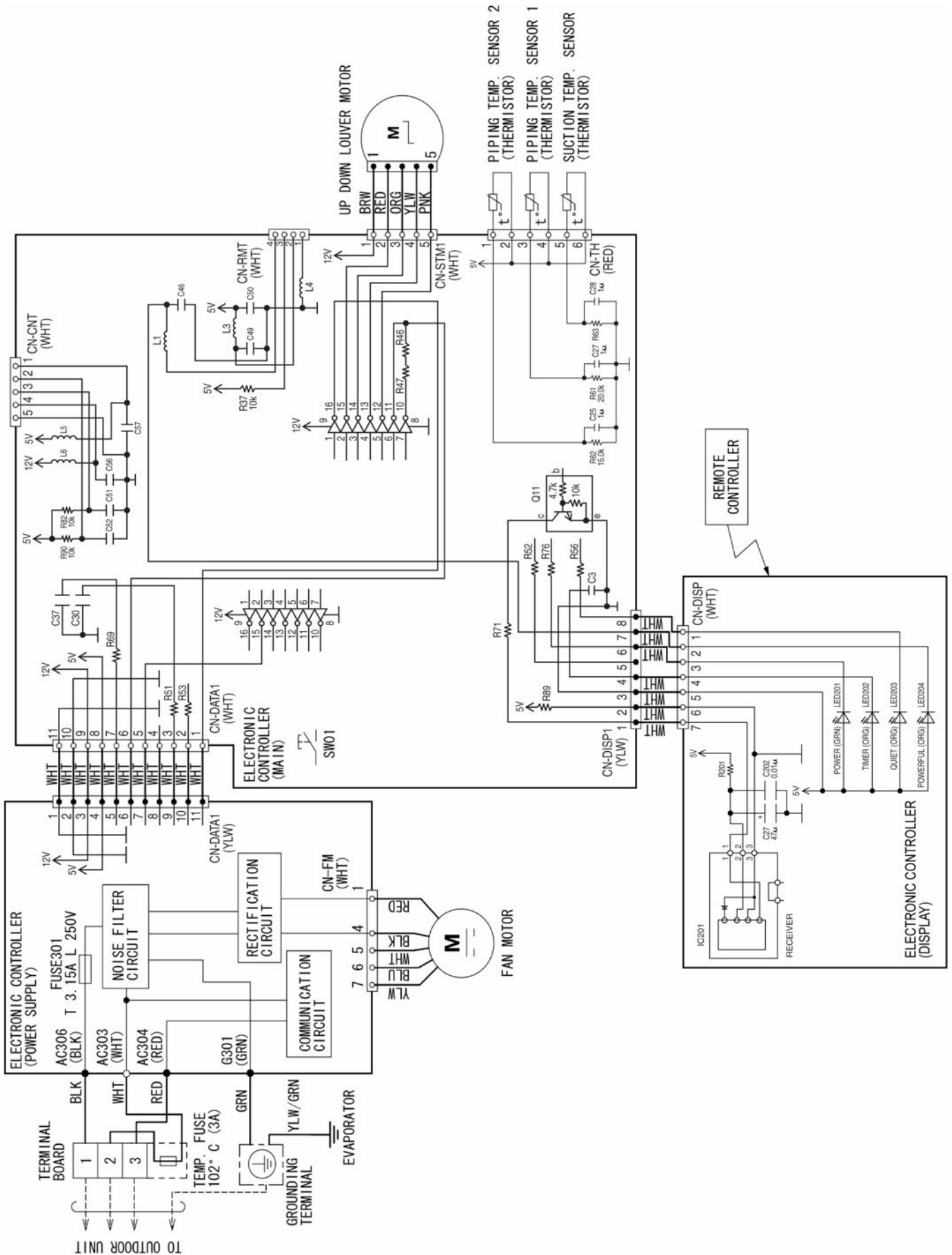

9.2 Outdoor Unit

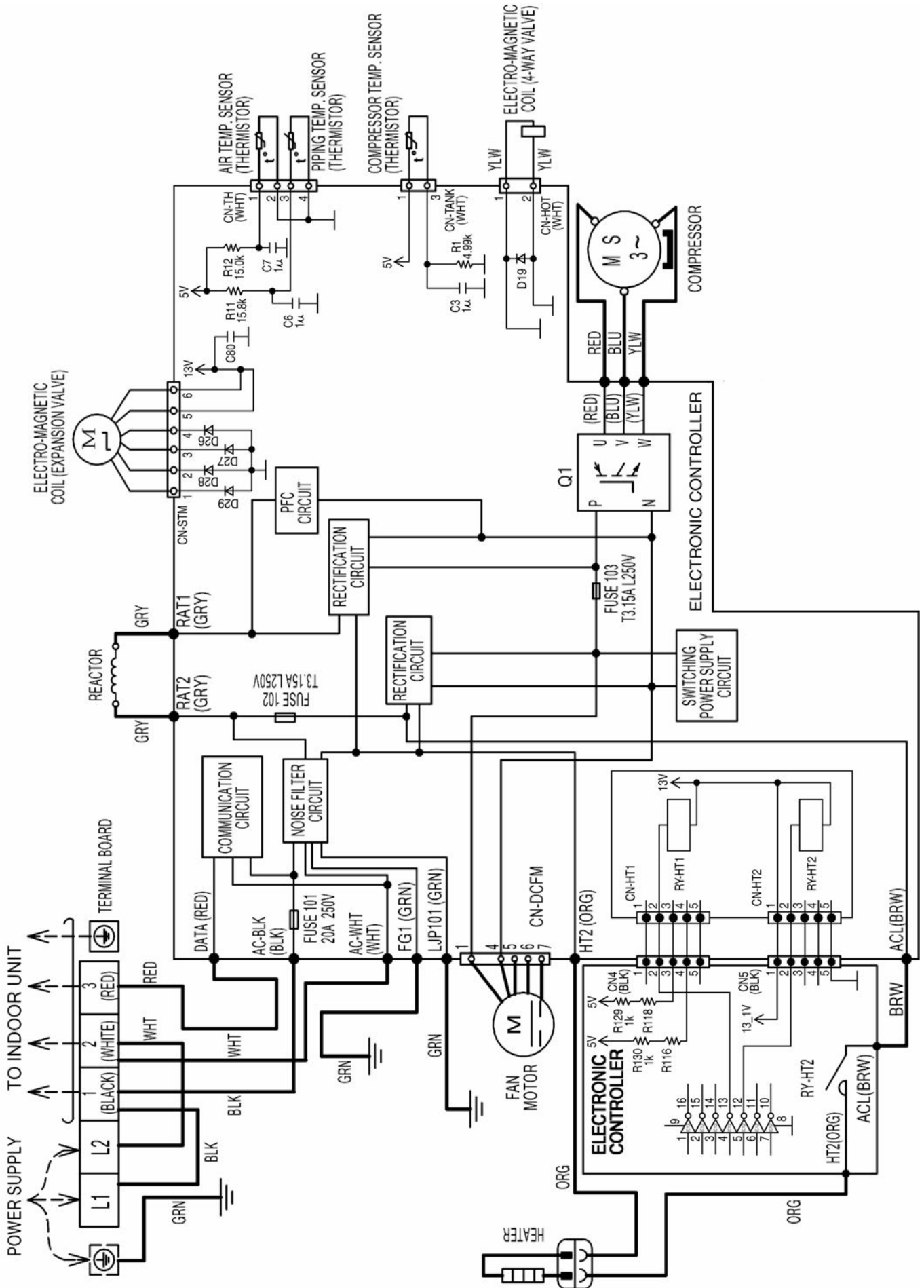

10. Printed Circuit Board

10.1 Indoor Unit

10.1.1 Main Printed Circuit Board

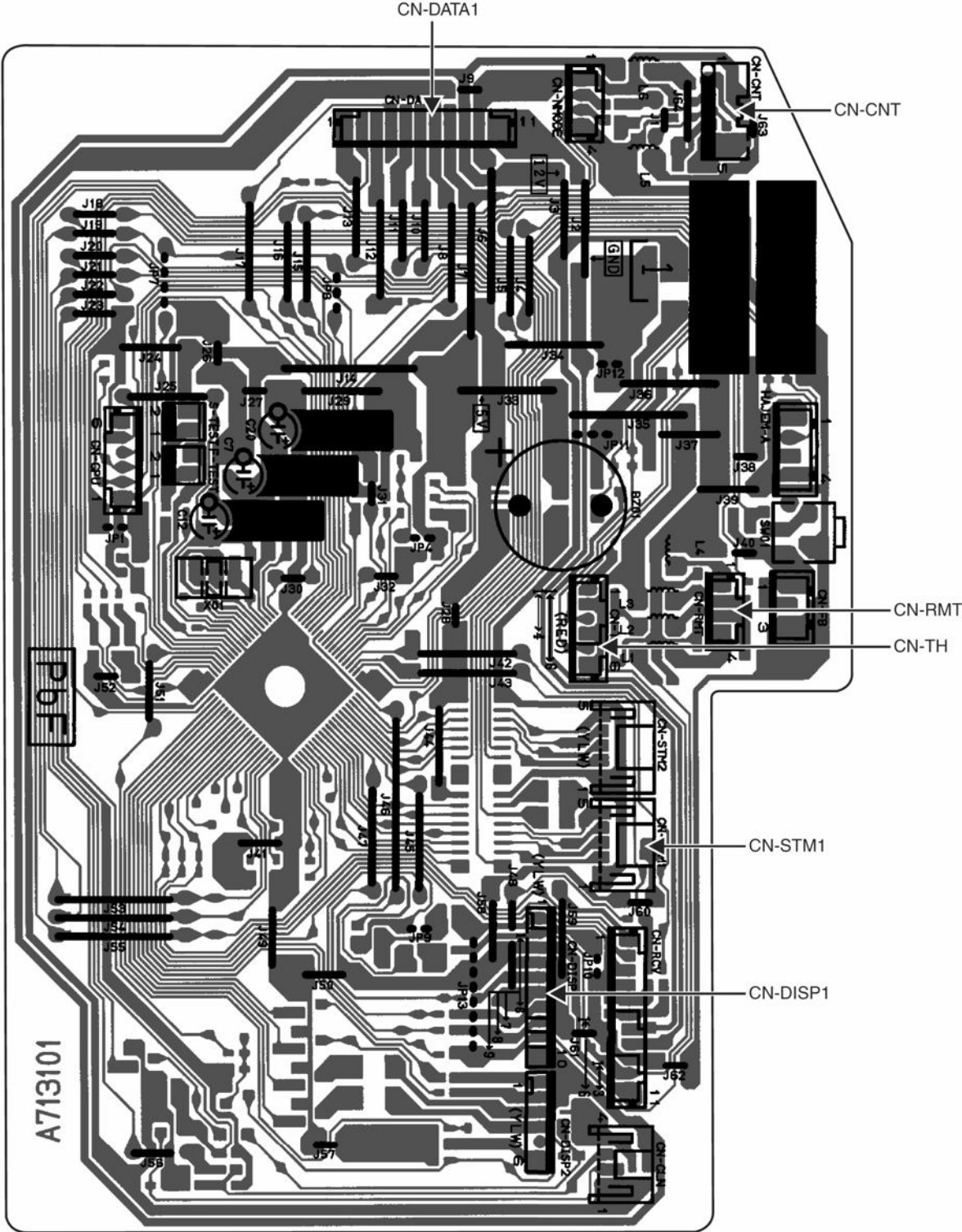

10.1.2 Power Printed Circuit Board

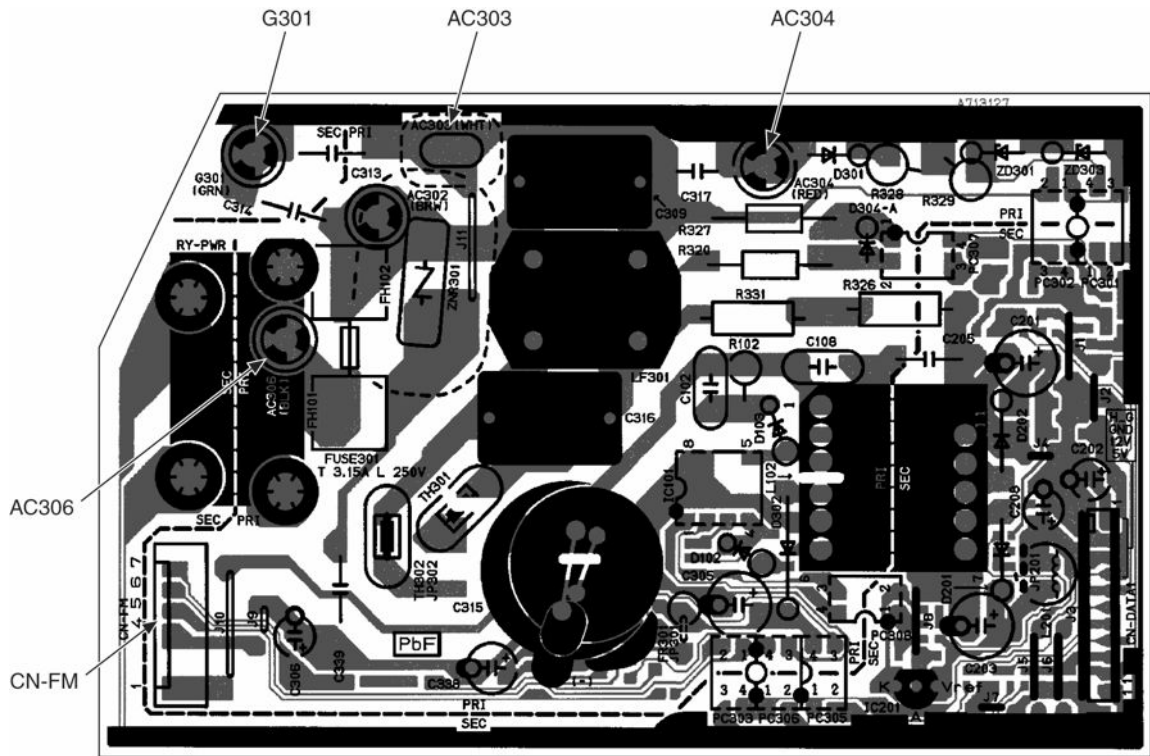

10.1.3 Indicator Printed Circuit Board

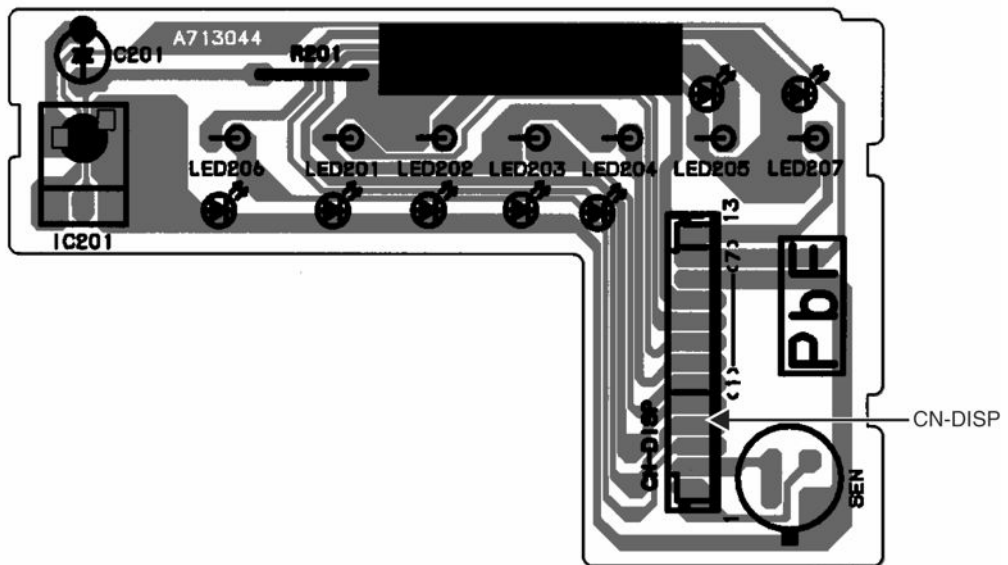

10.2 Outdoor Unit

10.2.1 Main Printed Circuit Board

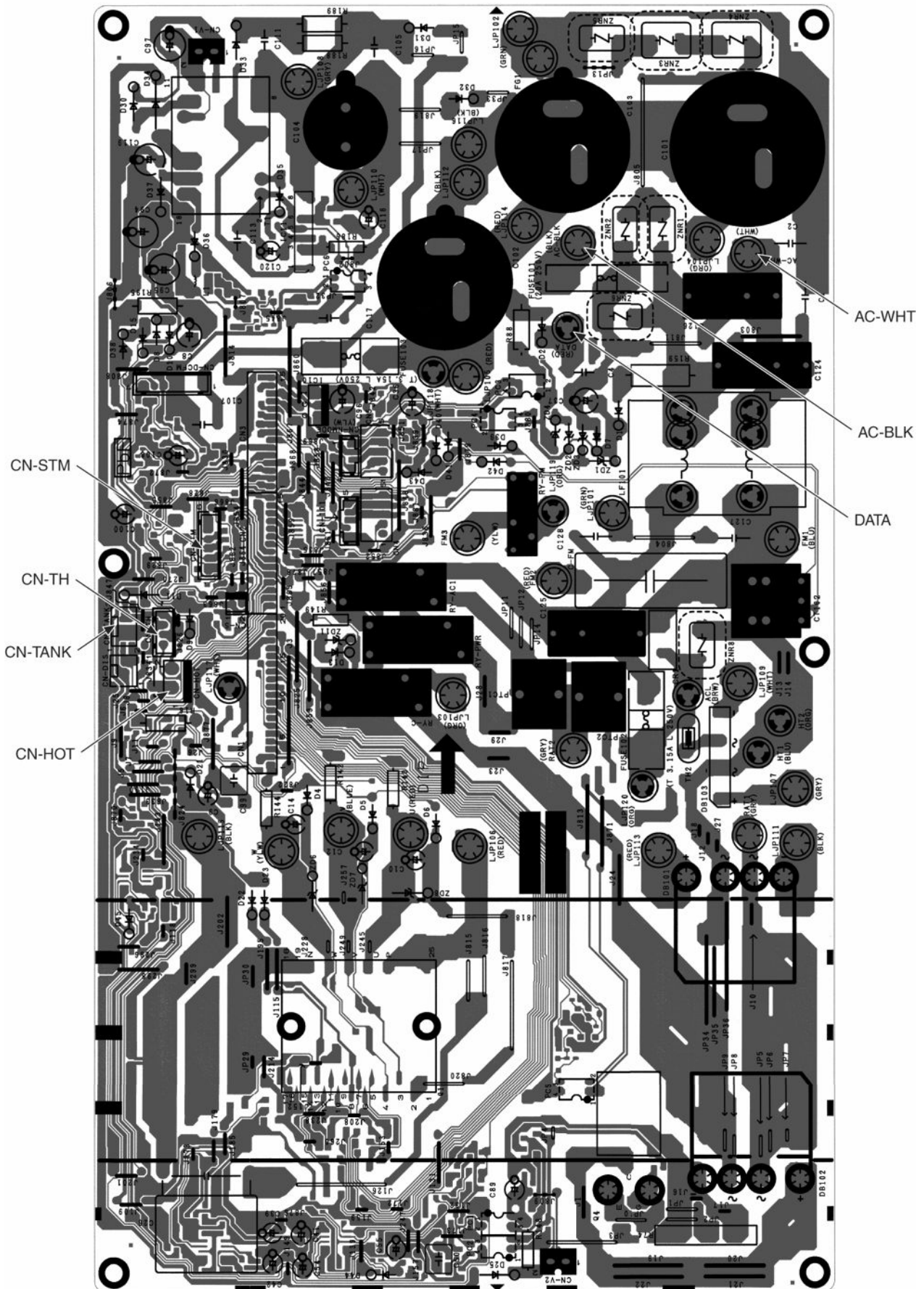

11. Installation Instruction

11.1 Select the Best Location

11.1.1 Indoor Unit

- Do not install the unit in excessive oil fume area such as kitchen, workshop and etc.
- There should not be any heat source or steam near the unit.
- There should not be any obstacles blocking the air circulation.
- A place where air circulation in the room is good.
- A place where drainage can be easily done.
- A place where noise prevention is taken into consideration.
- Do not install the unit near the door way.
- Ensure the spaces indicated by arrows from the wall, ceiling, fence or other obstacles.
- Recommended installation height for indoor unit shall be at least 8.2 ft.

11.1.2 Outdoor Unit

- If an awning is built over the unit to prevent direct sunlight or rain, be careful that heat radiation from the condenser is not obstructed.
- There should not be any animal or plant which could be affected by hot air discharged.
- Keep the spaces indicated by arrows from wall, ceiling, fence or other obstacles.
- Do not place any obstacles which may cause a short circuit of the discharged air.
- If piping length is over the [piping length for additional gas], additional refrigerant should be added as shown in the table.
- Recommended installation height for outdoor unit should be above the seasonal snow level.

Model	Capacity (Btu/h)	Piping size		Std. Length (ft)	Max. Elevation (ft)	Min. Piping Length (ft)	Max. Piping Length (ft)	Additional Refrigerant (oz/ft)	Piping Length for add. gas (ft)
		Gas	Liquid						
E9NKAUAW	8500	3/8"	1/4"	24.6	49.2	9.8	65.6	0.2	24.6
E12NKAUAW	12000	1/2"							

Example: For E9NKAUAW

If the unit is installed at 32.8 ft distance, the quantity of additional refrigerant should be 1.64 oz
 $(32.8 - 24.6) \text{ ft} \times 0.2 \text{ oz/ft} = 1.64 \text{ oz.}$

11.1.3 Indoor/Outdoor Unit Installation Diagram

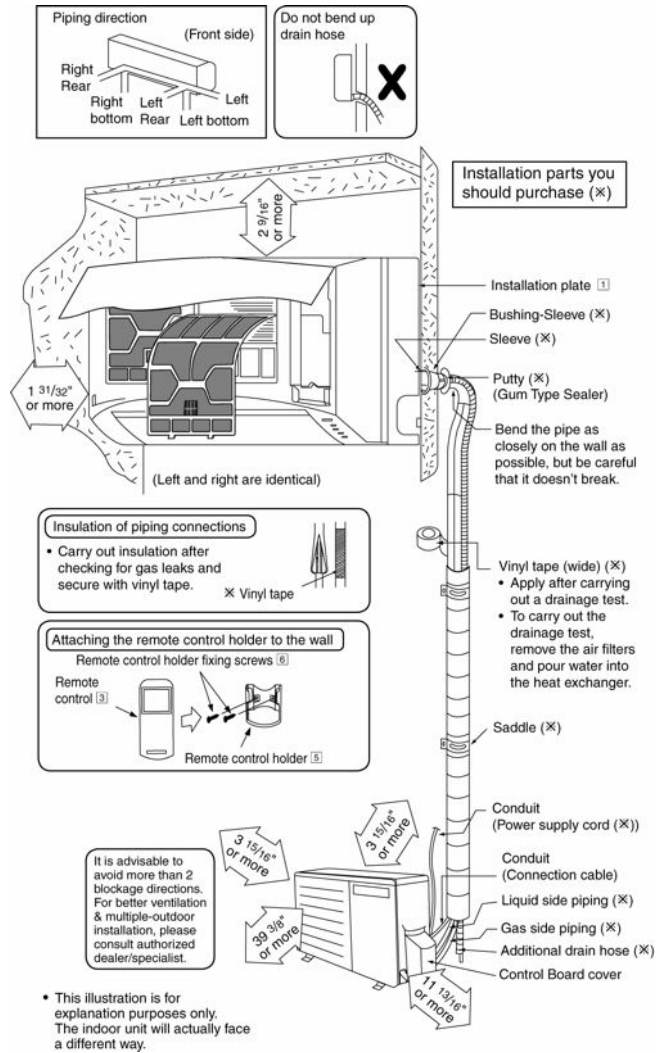

11.2 Indoor Unit

11.2.1 How to Fix Installation Plate

The mounting wall shall be strong and solid enough to prevent it from the vibration.

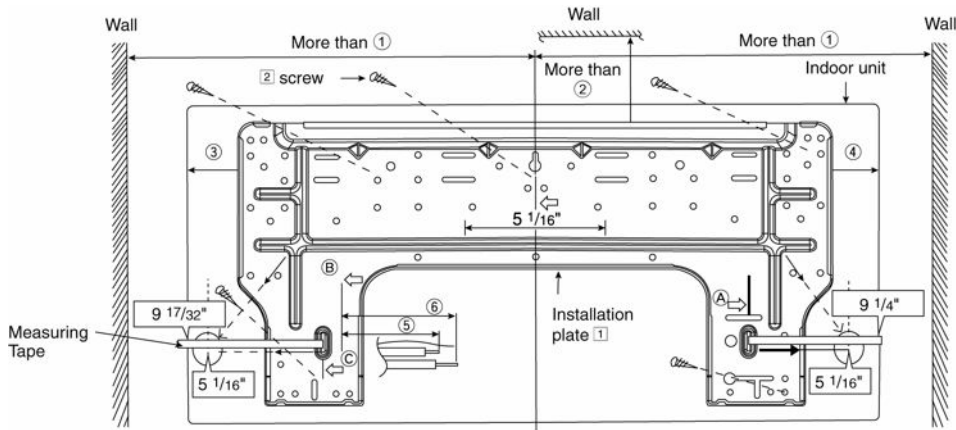

Model	Dimension					
	①	②	③	④	⑤	⑥
E9NKUAW, E12NKUAW	19 3/32"	3 7/32"	6 1/2"	6 7/32"	1 11/16"	3 3/4"

The center of installation plate should be at more than ① at right and left of the wall.

The distance from installation plate edge to ceiling should more than ②.

From installation plate left edge to unit's left side is ③.

From installation plate right edge to unit's right side is ④.

- Ⓑ : For left side piping, piping connection for liquid should be about ⑤ from this line.
 : For left side piping, piping connection for gas should be about ⑥ from this line.

- Mount the installation plate on the wall with 5 screws or more (at least 5 screws).
 (If mounting the unit on the concrete wall, consider using anchor bolts.)
 - Always mount the installation plate horizontally by aligning the marking-off line with the thread and using a level gauge.
- Drill the piping plate hole with $\varnothing 2\text{-}3/4\text{'}$ hole-core drill.
 - Line according to the left and right side of the installation plate. The meeting point of the extended line is the center of the hole. Another method is by putting measuring tape at position as shown in the diagram above. The hole center is obtained by measuring the distance namely $5\text{-}1/16\text{'}$ for left and right hole respectively.
 - Drill the piping hole at either the right or the left and the hole should be slightly slanting to the outdoor side.

11.2.2 To Drill a Hole in the Wall and Install a Sleeve of Piping

- Insert the piping sleeve to the hole.
- Fix the bushing to the sleeve.
- Cut the sleeve until it extrudes about $19/32\text{'}$ from the wall.

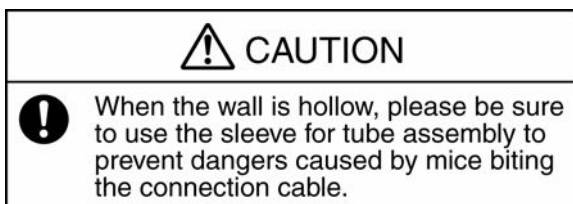

- Finish by sealing the sleeve with putty or caulking compound at the final stage.

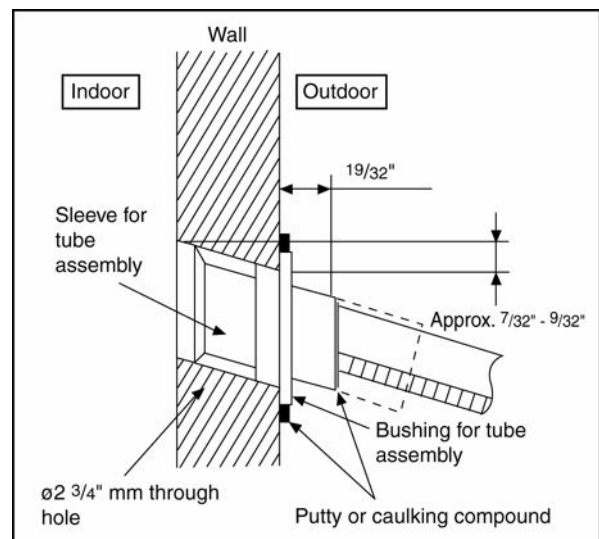

11.2.3 Indoor Unit Installation

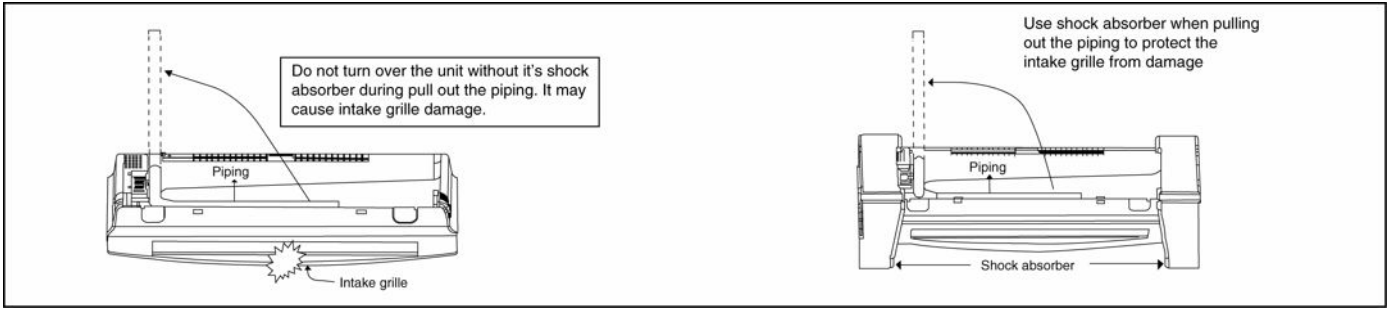

11.2.3.1 For the right rear piping

- Step-1 Pull out the Indoor piping
- Step-2 Install the Indoor Unit
- Step-3 Secure the Indoor Unit
- Step-4 Insert the connection cable

11.2.3.2 For the right bottom piping

- Step-1 Pull out the Indoor piping
- Step-2 Install the Indoor Unit
- Step-3 Insert the connection cable
- Step-4 Secure the Indoor Unit

11.2.3.3 For the embedded piping

- Step-1 Replace the drain hose
- Step-2 Bend the embedded piping
 - Use a spring bender or equivalent to bend the piping so that the piping is not crushed.
- Step-3 Pull the connection cable into Indoor Unit
 - The inside and outside connection cable can be connected without removing the front grille.
- Step-4 Cut and flare the embedded piping
 - When determining the dimensions of the piping, slide the unit all the way to the left on the installation plate.
 - Refer to the section "Cutting and flaring the piping".
- Step-5 Install the Indoor Unit
- Step-6 Connect the piping
 - Please refer to "Connecting the piping" column in outdoor unit section. (Below steps are done after connecting the outdoor piping and gas-leakage confirmation.)
- Step-7 Insulate and finish the piping
 - Please refer to "Piping and finishing" column of outdoor section and "Insulation of piping connection" column as mentioned in indoor/outdoor unit installation.
- Step-8 Secure the Indoor Unit

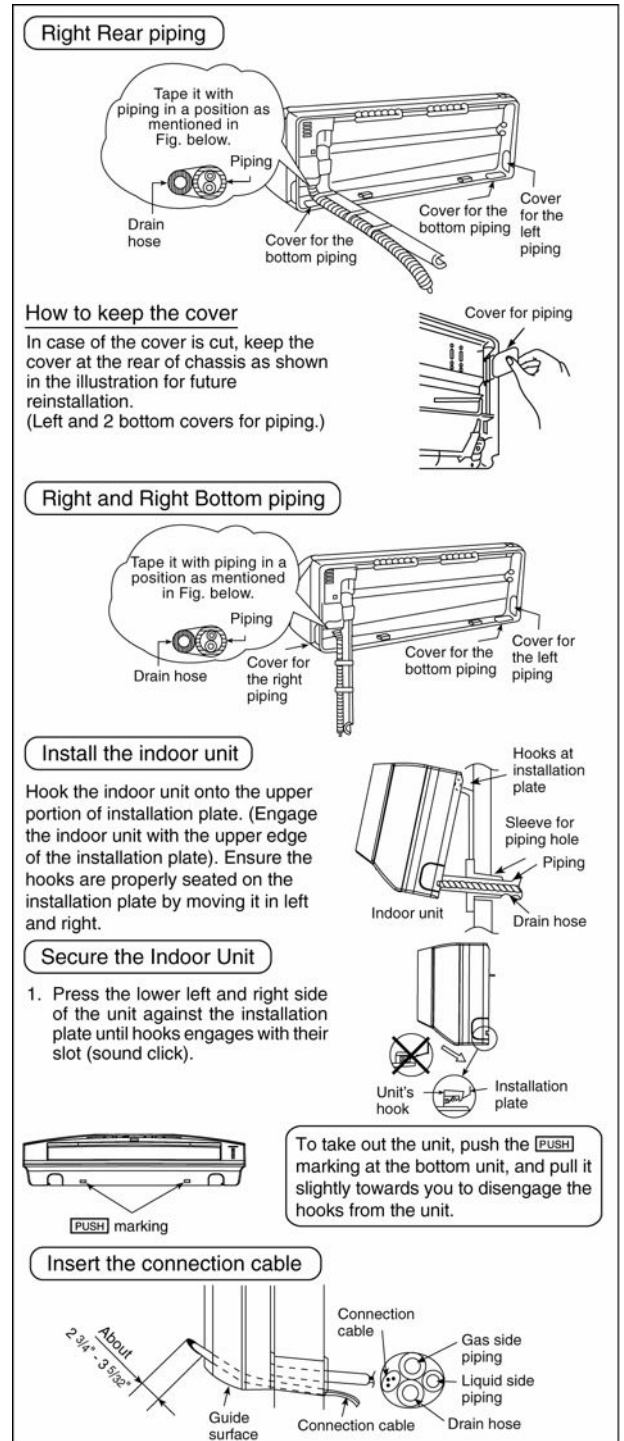

(This can be used for left rear piping and bottom piping also.)

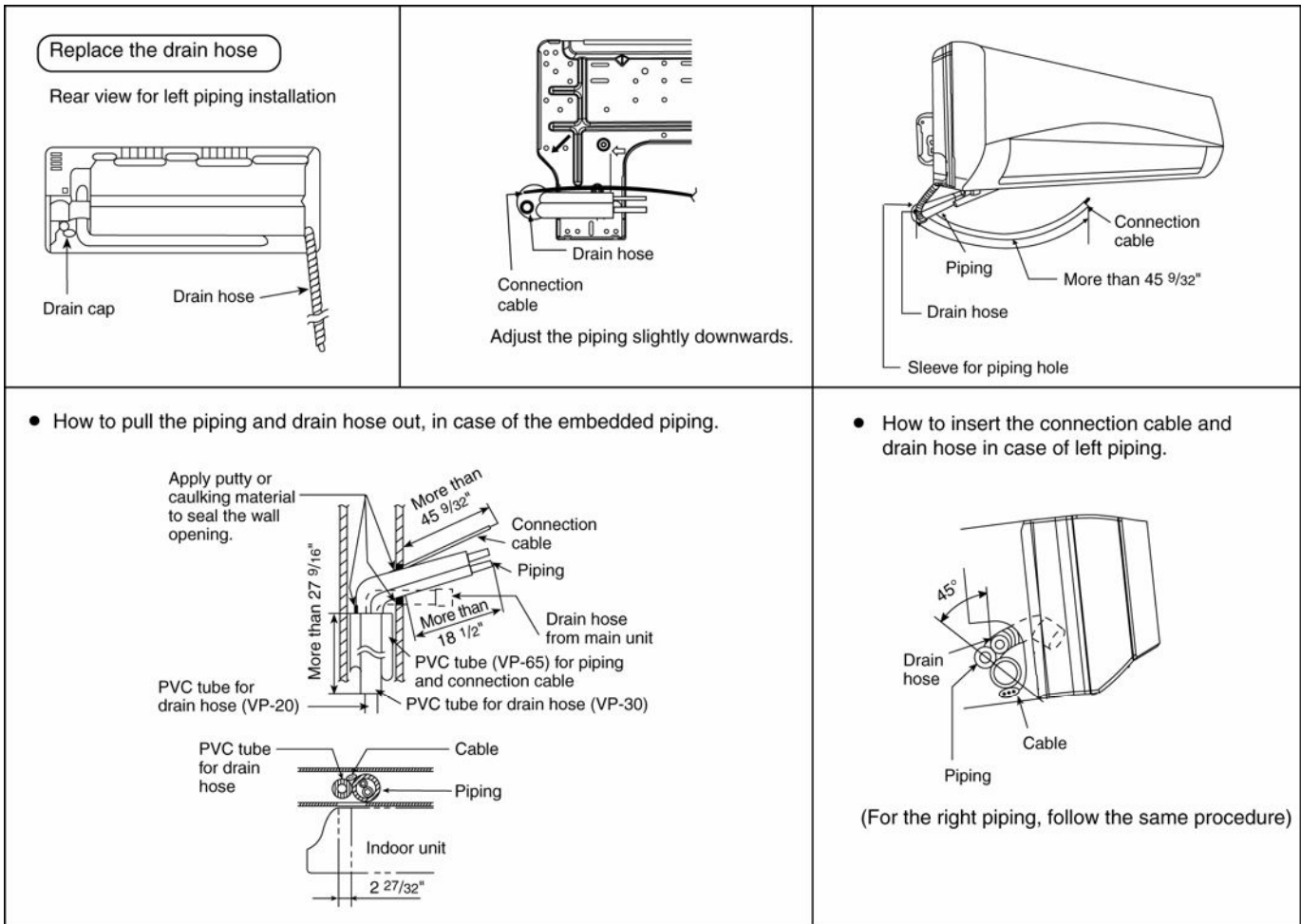

11.2.4 Connect the Cable to the Indoor Unit

- The inside and outside connection cable can be connected without removing the front grille.
- Unscrew the conduit cover and fix the conduit connector to conduit cover with lock nut, then secure it against chassis.
- Connection cable between indoor unit and outdoor unit should be UL listed or CSA approved 4 conductor wires minimum AWG16 in accordance with local electric codes.
 - Ensure the colour of wires of outdoor unit and terminal number are the same as the indoor's respectively.

Terminals on the indoor unit	1	2	3	
Colour of wires (connection cable)				
Terminals on the outdoor unit	1	2	3	

⚠ WARNING

This equipment must be properly earthed.

- Earth lead wire shall be Yellow/Green (Y/G) in colour and shall be longer than other lead wires as shown in the figure for electrical safety in case of the slipping.

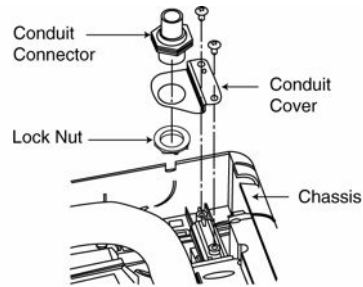

Rear Side of Indoor Unit

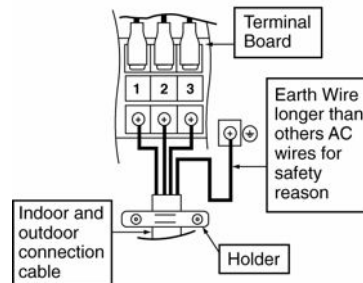

11.2.5 Wiring Stripping and connecting requirement

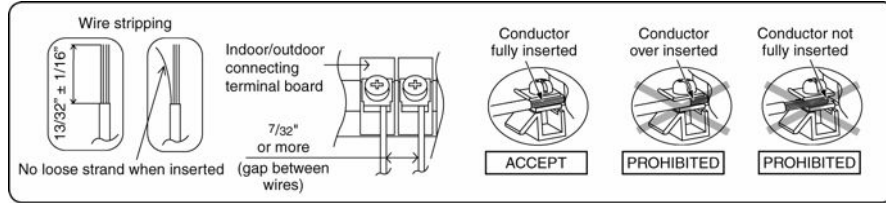

11.2.5.1 Cutting and flaring the piping

- 1 Please cut using pipe cutter and then remove the burrs.
- 2 Remove the burrs by using reamer. If burrs are not removed, gas leakage may be caused. Turn the piping end down to avoid the metal powder entering the pipe.
- 3 Please make flare after inserting the flare nut onto the copper pipes.

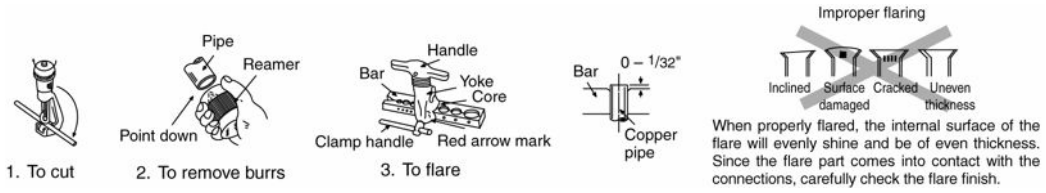

11.3 Outdoor Unit

11.3.1 Install the Outdoor Unit

- After selecting the best location, start installation according to indoor/outdoor unit installation diagram.
 - Fix the unit on concrete or rigid frame firmly and horizontally by bolt nut ($\phi 13/32$).
 - When installing at roof, please consider strong wind and earthquake.
Please fasten the installation stand firmly with bolt or nails.

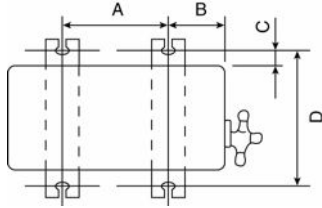

Model	A	B	C	D
E9NKUA, E12NKUA	22-7/16"	4-1/8"	23/32"	12-19/32"

11.3.2 Connect the Piping

11.3.2.1 Connecting the piping to indoor

Please make flare after inserting flare nut (locate at joint portion, of tube assembly) onto the copper pipe. (In case of using long piping)

Connect the piping

- Align the center of piping and sufficiently tighten the flare nut with fingers.
- Further tighten the flare nut with torque wrench in specified torque as stated in the table.

11.3.2.2 Connecting the piping to outdoor

Decide piping length and then cut by using pipe cutter. Remove burrs from cut edge.

Make flare after inserting the flare nut (locate at valve) onto the copper pipe.

Align center of piping to valves and then tighten with torque wrench to the specified torque as stated in the table.

Do not over tighten, over tightening may cause gas leakage.	
Piping size	Torque
1/4"	13.3 lbf.ft
3/8"	31.0 lbf.ft
1/2"	40.6 lbf.ft
5/8"	47.9 lbf.ft
3/4"	73.8 lbf.ft

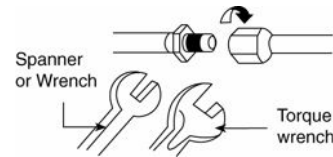

11.3.2.3 Connecting the piping to outdoor multi

Decide piping length and then cut by using pipe cutter. Remove burrs from cut edge.

Make flare after inserting the flare nut (locate at valve) onto the copper pipe.

Align center of piping to valve and then tighten with torque wrench to the specified torque as stated in the table.

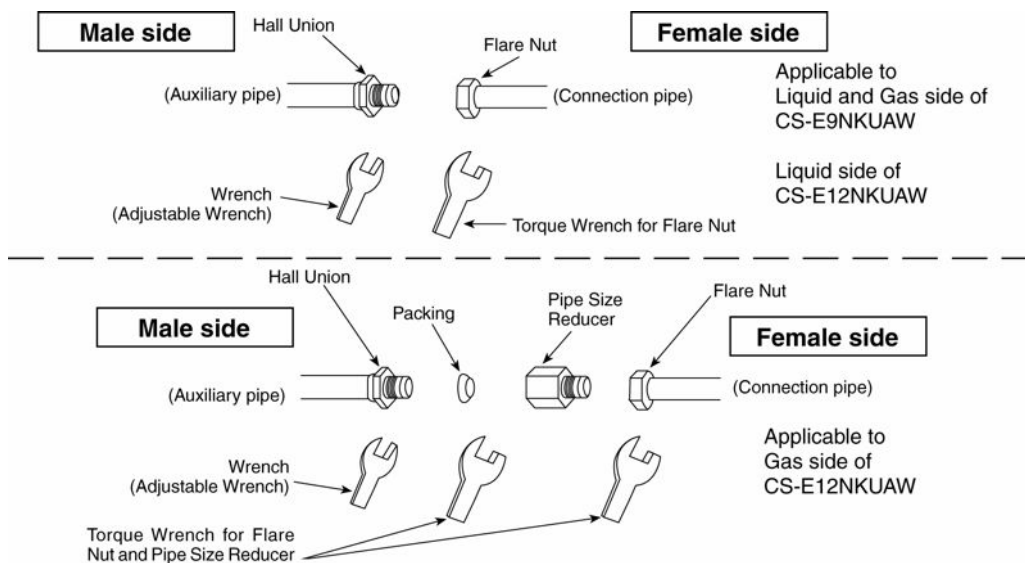

11.3.2.4 Gas Leak Checking

Pressure test to system to 400 PSIG with dry nitrogen, in stages. Thoroughly leak check the system.

If the pressure holds, release the nitrogen and proceed to section 11.3.3.

11.3.3 Evacuation of the equipment

WHEN INSTALLING AN AIR CONDITIONER, BE SURE TO EVACUATE THE AIR INSIDE THE INDOOR UNIT AND PIPES in the following procedures.

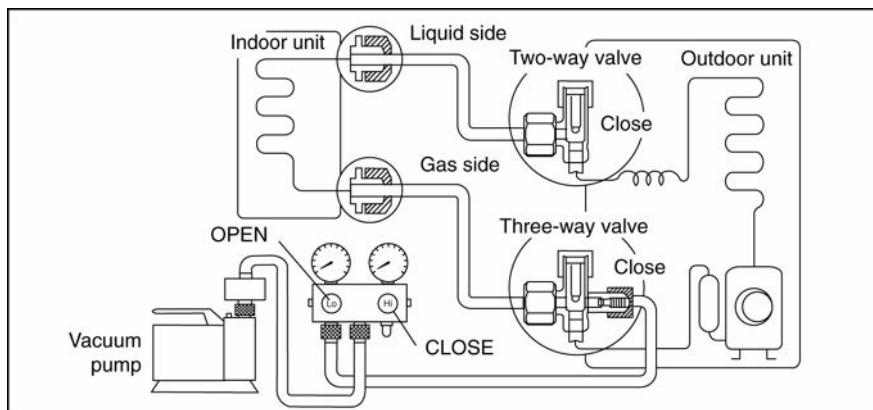

1. Connect a charging hose with a push pin to the Low side of a charging set and the service port of the 3-way valve.
2. Connect the micron gauge between vacuum pump and service port of outdoor units.
3. Turn on the power switch of the vacuum pump and make sure that connect digital micron gauge and to pull down to a value of 500 microns.
4. To make sure micron gauge a value 500 microns and close the low side valve of the charging set and turn off the vacuum pump.
5. Disconnect the vacuum pump house from the service port of the 3-way valve.
6. Tighten the service port caps of the 3-way valve at a torque of 13.3 lbf.ft with a torque wrench.
7. Remove the valve caps of both of the 2-way valve and 3-way valve. Position both of the valves to "Open" using a hexagonal wrench (5/32").

8. Mount valve caps onto the 2-way valve and the 3-way valve.
 - Be sure to check for gas leakage.

- If micron gauge value does not descend 500 microns, take the following measures:
 - If the leak stops when the piping connections are tightened further, continue working from step ③.
 - If the leak does not stop when the connections are retightened, repair location of leak.
 - Do not release refrigerant during piping work for installation and reinstallation.
 - Be careful with the liquid refrigerant, it may cause frostbite.

11.3.3.1 Connect the Cable to the Outdoor Unit

1. Remove Top panel.
2. Remove Control Board Cover (Resin and Metal).
3. Remove Plugs.
4. Fix the conduit connectors to the knockout holes with lock-nuts, then secure them against the side panel.
5. All wires pass through conduits.
6. Connection cable between indoor unit and outdoor unit should be UL listed or CSA approved 4 conductor wires minimum AWG16 in accordance with local electric codes.
7. Wire connection to the power supply (208/230V 60Hz) through circuit breaker.
 - Connect the UL listed or CSA approved wires minimum AWG14 to the terminal board, and connect the other end of the wires to ELCB / GFCI.
8. Connect the power supply cord and connection cable between indoor unit and outdoor unit according to the diagram below.

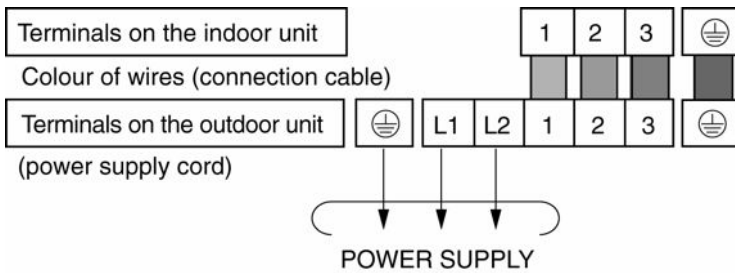
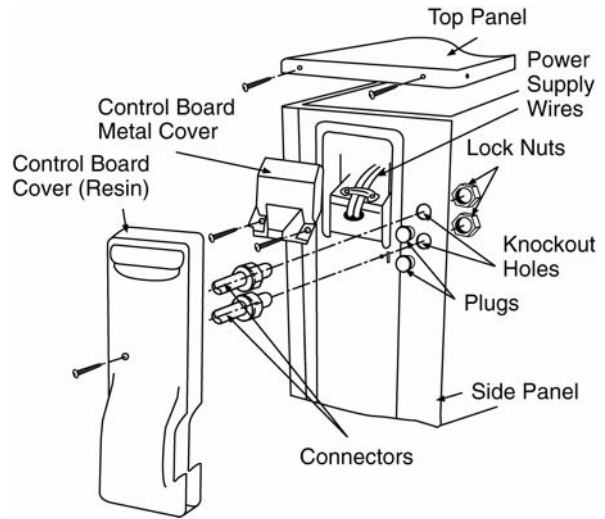

9. Secure the wire onto the control board with the holder (clammer).
10. After completing wiring connections, reattach the control board cover (Metal and Resin) and the top panel to the original position with the screws.
11. For wire stripping and connection requirement, refer to instruction 11.2.4 of indoor unit.

⚠ WARNING

⚡ This equipment must be properly earthed.

- Earth lead wire shall be Yellow/Green (Y/G) in colour and shall be longer than other lead wires as shown in the figure for electrical safety in case of the slipping.

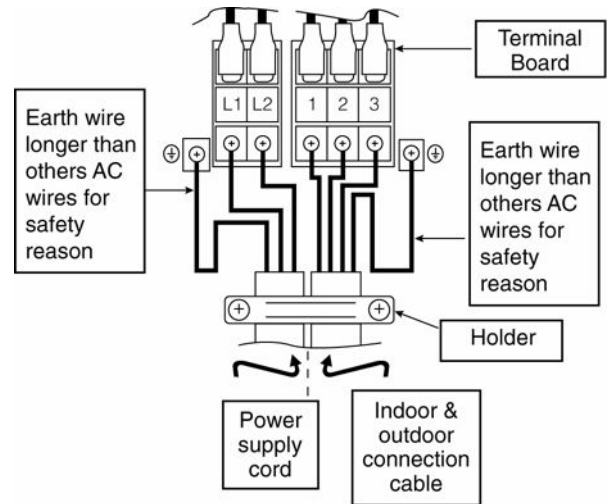

11.3.3.2 Piping Insulation

1. Please carry out insulation at pipe connection portion as mentioned in Indoor/Outdoor Unit Installation Diagram. Please wrap the insulated piping end to prevent water from going inside the piping.
2. If drain hose or connecting piping is in the room (where dew may form), please increase the insulation by using POLY-E-FOAM with thickness 1/4" or above.

12. Operation Control

12.1 Basic Function

Inverter control, which equipped with a microcomputer in determining the most suitable operation mode as time passes, automatically adjusts output power for maximum comfort always. In order to achieve the suitable operation mode, the microcomputer maintains the set temperature by measuring the temperature of the environment and performing temperature shifting. The compressor at outdoor unit is operating following the frequency instructed by the microcomputer at indoor unit that judging the condition according to internal setting temperature and intake air temperature.

12.1.1 Internal Setting Temperature

Once the operation starts, remote control setting temperature will be taken as base value for temperature shifting processes. These shifting processes are depending on the air conditioner settings and the operation environment. The final shifted value will be used as internal setting temperature and it is updated continuously whenever the electrical power is supplied to the unit.

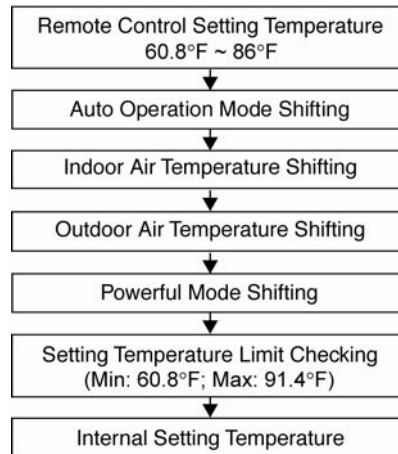

12.1.2 Cooling Operation

12.1.2.1 Thermostat control

- Compressor is OFF when Intake Air Temperature - Internal Setting Temperature < 29.3°F.
- Compressor is ON after waiting for 3 minutes, if the Intake Temperature - Internal Setting Temperature > Compressor OFF point.

12.1.3 Soft Dry Operation

12.1.3.1 Thermostat control

- Compressor is OFF when Intake Temperature - Internal Setting Temperature < 28.4°F.
- Compressor is ON after waiting for 3 minutes, if the Intake Air Temperature - Internal Setting Temperature > Compressor OFF point.

12.1.4 Heating Operation

12.1.4.1 Thermostat control

- Compressor is OFF when Intake Temperature - Internal Setting Temperature > 35.6°F.
- Compressor is ON after waiting for 3 minutes, if the Intake Air Temperature - Internal Setting Temperature < Compressor OFF point

12.1.4.2 Automatic Operation

- This mode can be set using remote control and the operation is decided by remote control setting temperature, remote control operation mode, indoor intake air temperature and outdoor air temperature.
- During operation mode judgment, indoor fan motor (with speed of Lo-) and outdoor fan motor are running for 30 seconds to detect the indoor intake and outdoor air temperature. The operation mode is decided based on below chart.

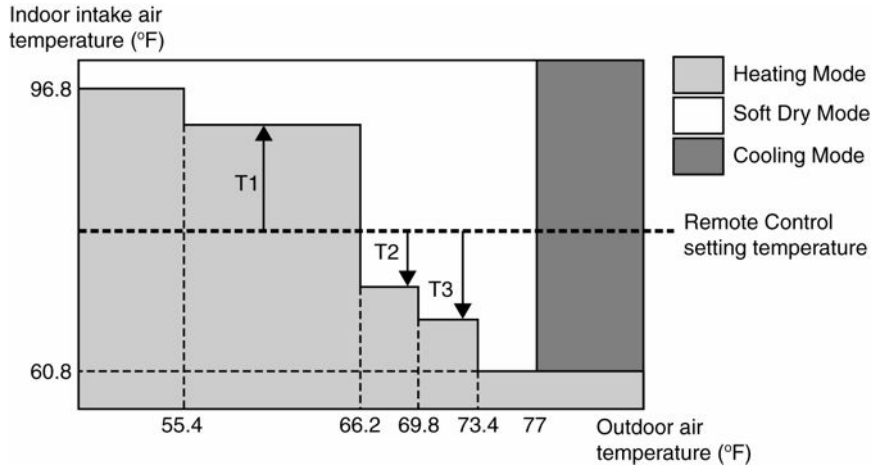

- Every 30 minutes, the indoor and outdoor temperature is judged. Based on remote control setting temperature, the value of T1 will increase up to 50°F, T2 will decrease by 37.4°F and T3 will decrease up to 46.4°F.
- The Auto Operation Mode shifting will take place whenever operation mode changed from Cool/Soft Dry to Heating or vice versa.

12.2 Indoor Fan Motor Operation

12.2.1 Basic Rotation Speed (rpm)

- Manual Fan Speed
[Cooling, Dry]
 - Fan motor's number of rotation is determined according to remote control setting.

Remote control	○	○	○	○	○
Tab	Hi	Me+	Me	Me-	Lo

[Heating]

- Fan motor's number of rotation is determined according to remote control setting.

Remote control	○	○	○	○	○
Tab	Shi	Me+	Me	Me-	Lo

- Auto Fan Speed
[Cooling, Dry]
 - According to room temperature and setting temperature, indoor fan speed is determined automatically.
 - The indoor fan will operate according to pattern below.

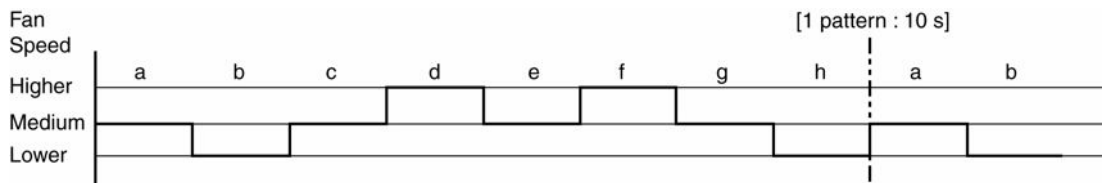

- During operation, indoor fan motor may stop due to odor prevention.

[Heating]

- According to indoor pipe temperature, automatic heating fan speed is determined as follows.

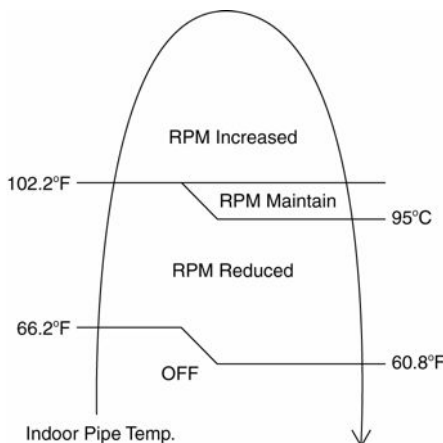

- Feedback control
 - Immediately after the fan motor started, feedback control is performed once every second.
 - During fan motor on, if fan motor feedback ≥ 2550 rpm or < 50 rpm continue for 10 seconds, then fan motor error counter increase, fan motor is then stop and restart. If the fan motor counter becomes 7 times, then H19 - fan motor error is detected. Operation stops and cannot on back.

12.3 Outdoor Fan Motor Operation

Outdoor fan motor is operated with fan speed number of rotation. It starts when compressor starts operation and it stops 30 seconds after compressor stops operation.

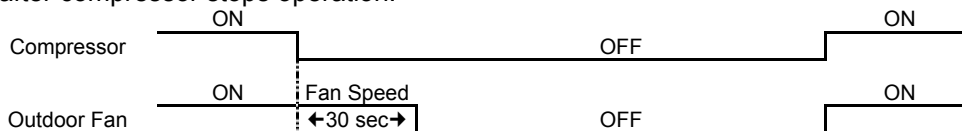

12.4 Airflow Direction

- There are two types of airflow, vertical airflow (directed by horizontal vane) and horizontal airflow (directed by vertical vanes).
- Control of airflow direction can be automatic (angles of direction is determined by operation mode, heat exchanger temperature and intake air temperature) and manual (angles of direction can be adjusted using remote control).

12.4.1 Vertical Airflow

Operation Mode	Airflow Direction		Vane Angle (°)				
			1	2	3	4	5
Heating	Auto with Heat Exchanger Temperature	A	20				
		B	57				
		C	32				
	Manual		20	32	45	57	68
Cooling	Auto		20 ~ 45				
	Manual		20	26	32	37	45
Soft Dry	Auto		20 ~ 45				
	Manual		20	26	32	37	45

- Automatic vertical airflow direction can be set using remote control; the vane swings up and down within the angles as stated above. For heating mode operation, the angle of the vane depends on the indoor heat exchanger temperature as Figure 1 below. When the air conditioner is stopped using remote control, the vane will shift to close position.
- Manual vertical airflow direction can be set using remote control; the angles of the vane are as stated above and the positions of the vane are as Figure 2 below. When the air conditioner is stopped using remote control, the vane will shift to close position.

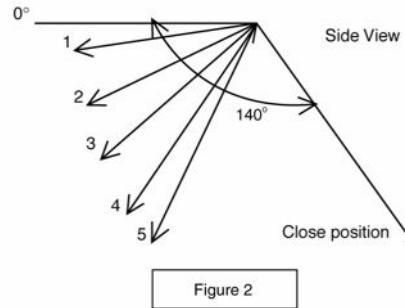
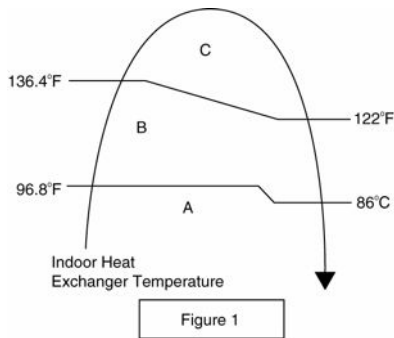

12.4.2 Horizontal Airflow

The horizontal airflow direction louvers can be adjusted manually by hand.

12.5 Quiet Operation (Cooling Mode/Cooling Area of Dry Mode)

- Purpose
 - To provide quiet cooling operation compare to normal operation.
- Control condition
 - Quiet operation start condition
 - When “Quiet” button at remote control is pressed. Quiet LED illuminates.
 - Quiet operation stop condition
 - When one of the following conditions is satisfied, quiet operation stops:
 - Powerful button is pressed.
 - Stop by OFF/ON button.
 - OFF Timer activates.
 - Quiet button is pressed again.
 - When quiet operation is stopped, operation is shifted to normal operation with previous setting.
 - When fan speed is changed, quiet operation is shifted to quiet operation of the new fan speed.
 - When operation mode is changed, quiet operation is shifted to quiet operation of the new mode.
 - During quiet operation, if ON timer activates, quiet operation maintains.
 - After off, when on back, quiet operation is not memorised.
- Control contents
 - Auto fan speed is change from normal setting to quiet setting of respective fan speed. This is to reduce sound of Hi, Me, Lo for 3dB.
 - Manual fan speed for quiet operation is -1 step from setting fan speed.

12.6 Quiet Operation (Heating)

- Purpose
 - To provide quiet heating operation compare to normal operation.
- Control condition
 - Quiet operation start condition
 - When “Quiet” button at remote control is pressed. Quiet LED illuminates.
 - Quiet operation stop condition
 - When one of the following conditions is satisfied, quiet operation stops:
 - Powerful button is pressed.
 - Stop by OFF/ON button.
 - Timer “off” activates.
 - Quiet button is pressed again.
 - When quiet operation is stopped, operation is shifted to normal operation with previous setting.
 - When fan speed is changed, quiet operation is shifted to quiet operation of the new fan speed.
 - When operation mode is changed, quiet operation is shifted to quiet operation of the new mode.
 - During quiet operation, if timer “on” activates, quiet operation maintains.
 - After off, when on back, quiet operation is not memorised.

- Control contents
 - Fan speed auto
 - Indoor FM RPM depends on pipe temperature sensor of indoor heat exchanger. Auto fan speed is changed from normal setting to quiet setting of respective fan speed. This is to reduce sound of Hi, Me, Lo for 3dB.
 - Fan speed manual
 - Manual fan speed for quiet operation is -1 step from setting fan speed.

12.7 Powerful Mode Operation

- When the powerful mode is selected, the internal setting temperature will shift lower up to 35.6°F (for Cooling/Soft Dry) or higher up to 38.3°F (for Heating) than remote control setting temperature for 20 minutes to achieve the setting temperature quickly.

12.8 Timer Control

12.8.1 ON Timer Control

- ON Timer can be set using remote control, where the unit with timer set will start operation earlier than the setting time. This is to provide a comfortable environment when reaching the set ON time.
- 60 minutes before the set ON time, indoor (at fan speed of Lo-) and outdoor fan motor start operation for 30 seconds to determine the indoor intake air temperature and outdoor air temperature in order to judge the operation starting time.
- From the above judgment, the decided operation will start operation earlier than the set time as shown below.

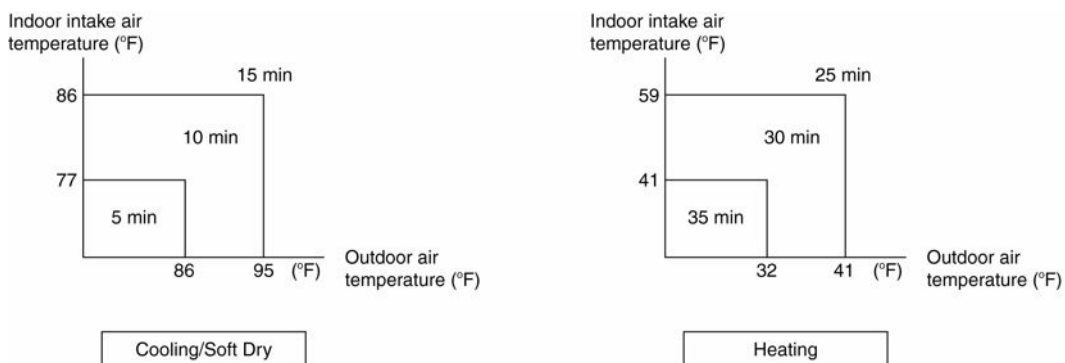

12.8.2 OFF Timer Control

- OFF Timer can be set using remote control, the unit with timer set will stop at set time.

12.9 Auto Restart Control

- When the power supply is cut off during the operation of air conditioner, the compressor will re-operate within three to four minutes (there are 10 patterns between 2 minutes 58 seconds and 3 minutes 52 seconds to be selected randomly) after power supply resumes.
- This type of control is not applicable during ON/OFF Timer setting.

12.10 Indication Panel

LED	POWER	TIMER	QUIET	POWERFUL
Color	Green	Orange	Orange	Orange
Light ON	Operation ON	Timer Setting ON	Quiet Mode ON	Powerful Mode ON
Light OFF	Operation OFF	Timer Setting OFF	Quiet Mode OFF	Powerful Mode OFF

Note:

- If POWER LED is blinking, the possible operation of the unit are Hot Start, during Deice operation, operation mode judgment, or ON timer sampling.
- If Timer LED is blinking, there is an abnormality operation occurs.

13. Operation Control (For Multi Split Connection)

During multi split connection, indoor unit's operation controls are same with single split connection unless specified in this chapter.

13.1 Cooling operation

13.1.1 Thermostat control

- Capability supply to indoor unit is OFF (Expansion valve closed) when Intake Air Temperature — Internal setting temperature < 28.4°F.
- Capability resume supply to indoor unit after waiting for 3 minutes, if the Intake Air temperature — Internal setting temperature > Capability supply OFF point.

13.2 Soft Dry Operation

13.2.1 Thermostat control

- Capability supply to indoor unit is OFF (Expansion valve closed) when Intake Air Temperature — Internal setting temperature < 26.6°F.
- Capability resume to indoor unit after waiting for 3 minutes, if the Intake Air temperature — Internal setting temperature > Capability supply OFF point.

13.3 Heating Operation

13.3.1 Thermostat control

- Capability supply to indoor unit is OFF (Expansion valve closed) when Intake Air Temperature — Internal setting temperature > 33.8°F.
- During this condition, the indoor fan is stopped if compressor is ON.
- Capability resume supply to indoor unit after waiting for 3 minutes, if the Intake Air Temperature — Internal setting temperature < Capability supply OFF point.

13.3.2 Temperature Sampling Control

- Temperature sampling is controlled by outdoor unit where room temperature for all power supply ON indoor unit could be obtained.
- When capability supply to the indoor unit is OFF and the compressor is ON during heating operation, the indoor fan motor is stopped. During this condition, 15 seconds after sampling signal from outdoor unit is received, the indoor fan start operation at low fan speed.
- However, within first 4 minutes of capability stopped supply to the indoor unit, even sampling signal is received, the sampling control is cancelled.

13.4 Automatic Operation

- This mode can be set using remote control and the operation is decided by remote control setting temperature, remote control operation mode, indoor intake and outdoor air temperature.
- During operation mode judgment, indoor fan motor (with speed of -Lo) and outdoor fan motor are running for 30 seconds to detect the indoor intake and outdoor air temperature. The operation mode is decided based on below chart.

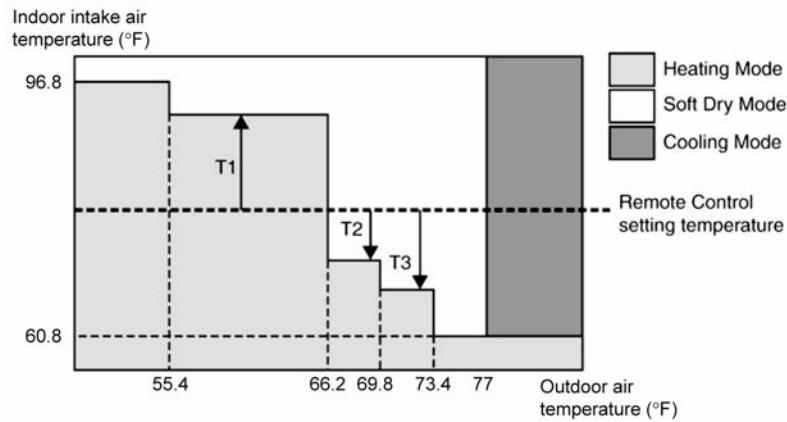

- Every 180 minutes, the indoor and outdoor temperature is judge. Based on remote control setting temperature, the value of T1 will increase up to 50°F, T2 will decrease by 37.4°F and T3 will decrease up to 46.4°F.

13.5 Indoor Fan Motor Operation

13.5.1 Residual Heat Removal Control

- To prevent high pressure at indoor unit, when heating mode thermostat-off condition or power supply OFF, indoor fan continue to operate at controlled fan speed for maximum 30 seconds then stop.

13.6 Powerful Mode Operation

- When the power mode is selected, the internal setting temperature will shift lower up to 39.2°F for Cooling/Soft Dry or higher up to 42.8°F for heating than remote control setting temperature, the powerful operation continue until user cancel the Powerful operation by pressing powerful button again.

13.7 Auto restart control

- When the power supply is cut off during the operation of air conditioner, the compressor will re-operate between three to four minutes (10 patterns to be selected randomly) after power resume.
- During multi split connection, Indoor unit will resume previous mode, include unit standby mode.

13.8 Indication Panel

LED	POWER	TIMER	QUIET	POWERFUL
Color	Green	Orange	Orange	Orange
Light ON	Operation ON	Timer Setting ON	Quiet Mode ON	Powerful Mode ON
Light OFF	Operation OFF	Timer Setting OFF	Quiet Mode OFF	Powerful Mode OFF

Note:

- If POWER LED is blinking (0.5 second ON, 0.5 second OFF), the possible operation of the unit are during Indoor Residual Heat Removal, Hot Start, during Deice operation, operation mode judgment, or ON timer sampling.
- If POWER LED is blinking (2.5 seconds ON, 0.5 second OFF), the unit is in standby mode.
- If TIMER LED is blinking, there is an abnormality operation occurs.

14. Protection Control

14.1 Protection Control For All Operations

14.1.1 Restart Control (Time Delay Safety Control)

- The compressor will not turn on within 3 minutes from the moment operation stops, although the unit is turned on again by pressing OFF/ON button at remote control within this period.
- This control is not applicable if the power supply is cut off and on again.
- This phenomenon is to balance the pressure inside the refrigerant cycle.

14.1.2 30 Seconds Forced Operation

- Once the air conditioner is turned on, the compressor will not stop within 30 seconds in a normal operation although the intake air temperature has reached the thermo-off temperature. However, force stop by pressing the OFF/ON button at the remote control is permitted or the Auto OFF/ON button at indoor unit.
- The reason for the compressor to force operation for minimum 30 seconds is to allow the refrigerant oil run in a full cycle and return back to the outdoor unit.

14.1.3 Total Running Current Control

- When the outdoor unit total running current (AC) exceeds X value, the frequency instructed for compressor operation will be decreased.
- If the running current does not exceed X value for 5 seconds, the frequency instructed will be increased.
- However, if total outdoor unit running current exceeds Y value, compressor will be stopped immediately for 3 minutes.

Model	E9NKUA		E12NKUA	
	X (A)	Y (A)	X (A)	Y (A)
Cooling / Soft Dry (A)	3.89	15.00	6.55	15.00
Cooling / Soft Dry (B)	3.28	15.00	6.10	15.00
Heating	5.50	15.00	7.05	15.00

1. The first 30 minutes of cooling operation, (A) will be applied.

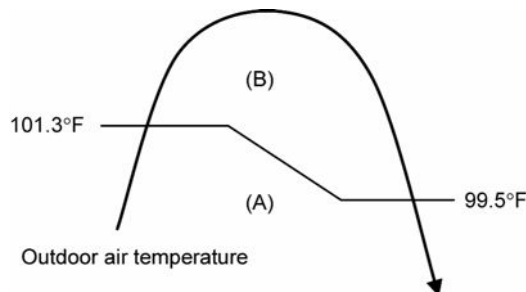

14.1.4 IPM (Power Transistor) Prevention Control

- Overheating Prevention Control
 - When the IPM temperature rises to 212°F, compressor operation will stop immediately.
 - Compressor operation restarts after 3 minutes the temperature decreases to 203°F.
 - If this condition repeats continuously 4 times within 20 minutes, timer LED will be blinking (“F96” is indicated).
- DC Peak Current Control
 - When electric current to IPM exceeds set value of 18.5A, the compressor will stop operate. Then, operation will restart after 3 minutes.
 - If the set value exceeds again more than 30 seconds after the compressor starts, the operation will restart after 2 minutes.
 - If the set value exceeds again within 30 seconds after the compressor starts, the operation will restart after 1 minute. If this condition repeats continuously for 7 times, all indoor and outdoor relays will be cut off, timer LED will be blinking (“F99” is indicated).

14.1.5 Compressor Overheating Prevention Control

- Instructed frequency for compressor operation will be regulated by compressor discharge temperature. The changes of frequency are as below.
- If compressor discharge temperature exceeds 224.6°F, compressor will be stopped, occurs 4 times per 20 minutes, timer LED will be blinking. ("F97" is indicated.)

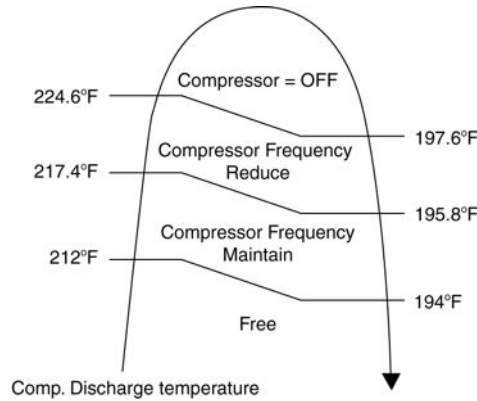

14.1.6 Low Pressure Prevention Control (Gas Leakage Detection)

- Control start conditions
 - For 5 minutes, the compressor continuously operates and outdoor total current is between 0.64A and 0.85A.
 - During Cooling and Soft Dry operations:
Indoor suction temperature - indoor piping temperature is below 39.2.°F.
 - During Heating operations:
Indoor piping temperature - indoor suction is under 41°F.
- Control contents
 - Compressor stops (and restart after 3 minutes).
 - If the conditions above happen 2 times within 20 minutes, the unit will:
 - Stop operation
 - Timer LED blinks and "F91" indicated.

14.1.7 Low Frequency Protection Control 1

- When the compressor operates at frequency lower than 24Hz continued for 240 minutes, the operation frequency will be changed to 25Hz for 2 minutes.

14.1.8 Low Frequency Protection Control 2

- When all below conditions comply, minimum limit of compressor will be set.

Temperature, T, for:	Cooling / Soft Dry	Heating
Indoor intake air (°F)	T < 57.2 or T ≥ 86	-
Outdoor air (°F)	T < 55.4 or T ≥ 100.4	T < 57.2 or T ≥ 82.4
Indoor heat exchanger (°F)	T < 86	T ≥ 32

14.2 Protection Control For Cooling & Soft Dry Operation

14.2.1 Outdoor Air Temperature Control

- The maximum current value is regulated when the outdoor air temperature rise above 57.2°F in order to avoid compressor overloading.

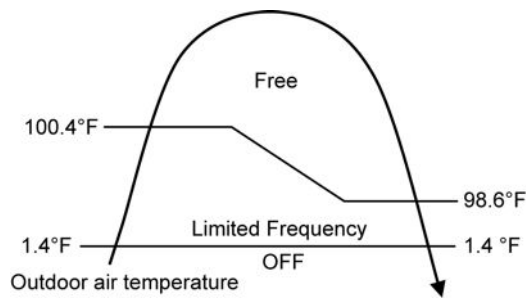

14.2.2 Cooling Overload Control

- Pipe temperature limitation / restriction.
 - Detects the outdoor pipe temperature and carry out restriction / limitation below (Limit the compressor operation frequency)
 - The compressor stops if outdoor pipe temperature exceeds 141.8°F.
 - If the compressor stops 4 times in 20 minutes, Timer LED blinks (“F95” indicated: Outdoor high pressure rise protection)

14.2.3 Freeze Prevention Control 1

- When indoor heat exchanger temperature is lower than 32°F continuously for 6 minutes, compressor will stops operation.
- Compressor will resume its operation 3 minutes after the indoor heat exchanger is higher than 41°F.
- At the same time, indoor fan speed will be higher than during its normal operation.
- If the indoor heat exchanger temperature is higher than 55.4°F for 5 minutes, the fan speed will return to its normal operation.

14.2.4 Freeze Prevention Control 2

- Control start conditions
 - During Cooling operation and soft dry operation
 - During thermo OFF condition, indoor intake temperature is less than 50°F or
 - Compressor stops for freeze prevention control
 - Either one of the conditions above occurs 5 times in 60 minutes.
- Control contents
 - Operation stops
 - Timer LED blinks and “H99” indicated

14.2.5 Dew Prevention Control 1

- To prevent dew formation at indoor unit discharge area.
- This control will be activated if:
 - Outdoor air temperature and Indoor pipe temperature judgment by microcontroller is fulfilled.
 - When Cooling or Dry mode is operated more than 20 minutes or more.
- This control stopped if:
 - Compressor stopped.
 - Remote control setting changed (fan speed / temperature).
 - Outdoor air temperature and indoor intake temperature changed.
- Fan speed, angle of louver (vertical airflow angle) will be adjusted accordingly in this control.
 1. Fan speed will be increased slowly when control is activated until predetermine value.
- Compressor frequency will be regulated accordingly.

14.2.6 Protection Control For Heating Operation

14.2.6.1 Intake Air Temperature Control

Compressor will operate at limited freq., if indoor intake air temperature is 95°C or above.

14.2.6.2 Outdoor Air Temperature Control

- The maximum current value is regulated when the outdoor air temperature rise above 57.2°F in order to avoid compressor overloading.

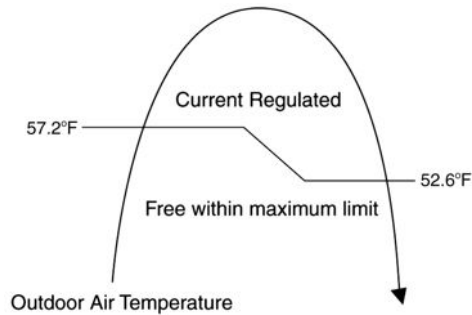

- The compressor will be stopped to avoid compressor overloading.

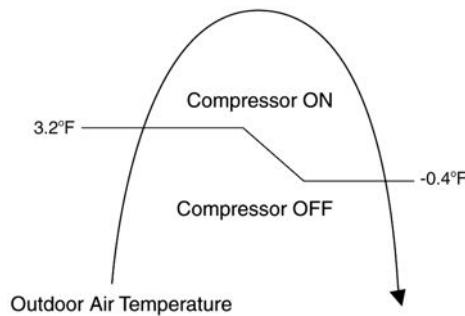

14.2.6.3 Overload Protection Control

- The compressor operating frequency is regulated in accordance to indoor heat exchanger temperature as shown below.
- If the heat exchanger temperature exceeds 60°C, compressor will stop.

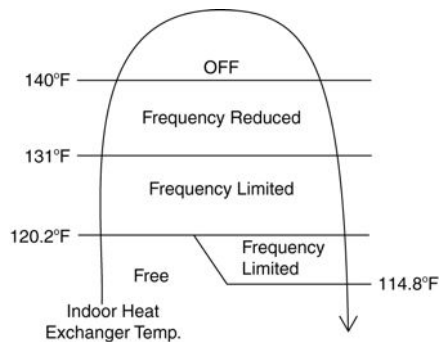

14.2.6.4 Low Temperature Compressor Oil Return Control

- In heating operation, if the outdoor temperature falls below 14°F when compressor starts, the compressor frequency will be regulated up to 600 seconds.

14.2.6.5 Cold Draught Prevention Control

- When indoor pipe temperature is low, cold draught operation starts where indoor fan speed will be reduced or stop.
- Horizontal vane angle may be adjusted in Auto vane setting.

14.2.6.6 Deice Operation

- When outdoor pipe temperature and outdoor air temperature is low, deice operation start where indoor fan motor and outdoor fan motor stop and operation LED blinks. Horizontal vane is closed during auto vane setting.

15. Servicing Mode

15.1 Auto Off/On Button

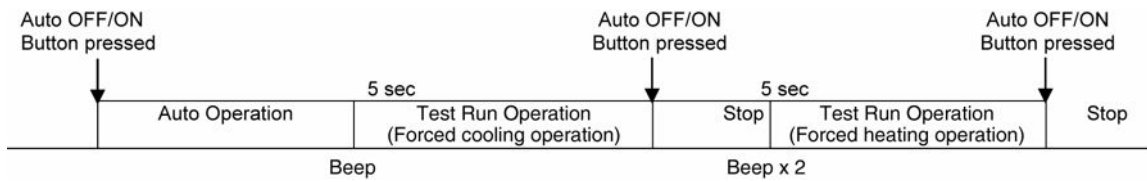

1 AUTO OPERATION MODE

The Auto operation will be activated immediately once the Auto OFF/ON button is pressed. This operation can be used to operate air conditioner with limited function if remote control is misplaced or malfunction.

2 TEST RUN OPERATION (FOR PUMP DOWN/SERVICING PURPOSE)

The Test Run operation will be activated if the Auto OFF/ON button is pressed continuously for more than 5 seconds. A “beep” sound will heard at the fifth seconds, in order to identify the starting of Test Run operation (Forced cooling operation). Within 5 minutes after Forced cooling operation start, the Auto OFF/ON button is pressed for more than 5 seconds. A 2 “beep” sounds will heard at the fifth seconds, in order to identify the starting of Forced heating operation.

The Auto OFF/ON button may be used together with remote control to set / change the advance setting of air conditioner operation.

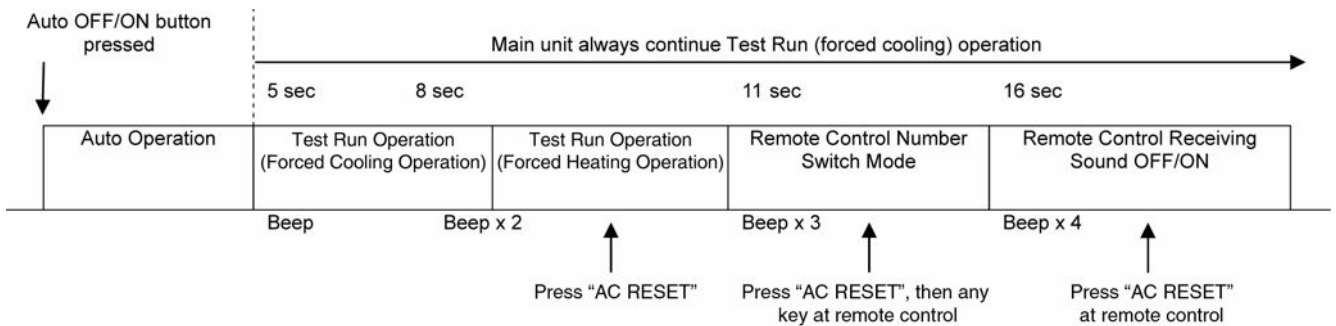

3 REMOTE CONTROL NUMBER SWITCH MODE

The Remote Control Number Switch Mode will be activated if the Auto OFF/ON button is pressed continuously for more than 11 seconds (3 “beep” sounds will occur at 11th seconds to identify the Remote Control Number Switch Mode is in standby condition) and press “AC RESET” button and then press any button at remote control to transmit and store the desired transmission code to the EEPROM.

There are 4 types of remote control transmission code could be selected and stored in EEPROM of indoor unit. The indoor unit will only operate when received signal with same transmission code from remote control. This could prevent signal interference when there are 2 or more indoor units installed nearby together.

To change remote control transmission code, short or open jumpers at the remote control printed circuit board.

Remote Control Printed Circuit Board		
Jumper A (J1)	Jumper B (D2)	Remote Control No.
Short	Open	A (Default)
Open	Open	B
Short	Short	C
Open	Short	D

- During Remote Control Number Switch Mode, press any button at remote control to transmit and store the transmission code to the EEPROM.

4 REMOTE CONTROL RECEIVING SOUND OFF/ON MODE

The Remote Control Receiving Sound OFF/ON Mode will be activated if the Auto OFF/ON button is pressed continuously for more than 16 seconds (4 “beep” sounds will occur at 16th seconds to identify the Remote Control Receiving Sound OFF/ON Mode is in standby condition) and press “AC Reset” button at remote control.

Press Auto OFF/ON button to toggle remote control receiving sound.

- Short “beep”: Turn OFF remote control receiving sound.
- Long “beep”: Turn ON remote control receiving sound.

After Auto OFF/ON button is pressed, the 20 seconds counter for Remote Control Receiving Sound OFF/ON Mode is restarted.

15.2 Remote Control Button

15.2.1 SET Button

- To check remote control transmission code and store the transmission code to EEPROM
 - Press “Set” button continuously for 10 seconds by using pointer
 - Press “Timer Set” button until a “beep” sound is heard as confirmation of transmission code change.

15.2.2 RESET (RC)

- To clear and restore the remote control setting to factory default.
 - Press once to clear the memory

15.2.3 RESET (AC)

- To restore the unit’s setting to factory default.
 - Press once to restore the unit’s setting

15.2.4 TIMER ▲

- To change indoor unit indicator’s LED intensity:
 - Press continuously for 5 seconds.

15.2.5 TIMER ▼

- To change remote control display from Degree Celsius (°C) to Degree Fahrenheit (°F)
 - Press continuously for 10 seconds.

15.2.6 CLOCK Button

- To change the remote control time format:
 - Press for more than 5 seconds

16. Troubleshooting Guide

16.1 Refrigeration Cycle System

In order to diagnose malfunctions, make sure that there are no electrical problems before inspecting the refrigeration cycle. Such problems include insufficient insulation, problem with the power source, malfunction of a compressor and a fan. The normal outlet air temperature and pressure of the refrigeration cycle depends on various conditions, the standard values for them are shown in the table on the right.

Normal Pressure and Outlet Air Temperature (Standard)

	Gas Pressure PSI (kg/cm ² G)	Outlet air Temperature (°F)
Cooling Mode	130.53 ~ 174.04 (9 ~ 12)	53.6 ~ 60.8
Heating Mode	333.58 ~ 420.60 (23 ~ 29)	96.8 ~ 113

Condition: Indoor fan speed = High
 Outdoor temperature 95°F at cooling mode
 and 44.6°F at heating mode.
 Compressor operate at rated frequency

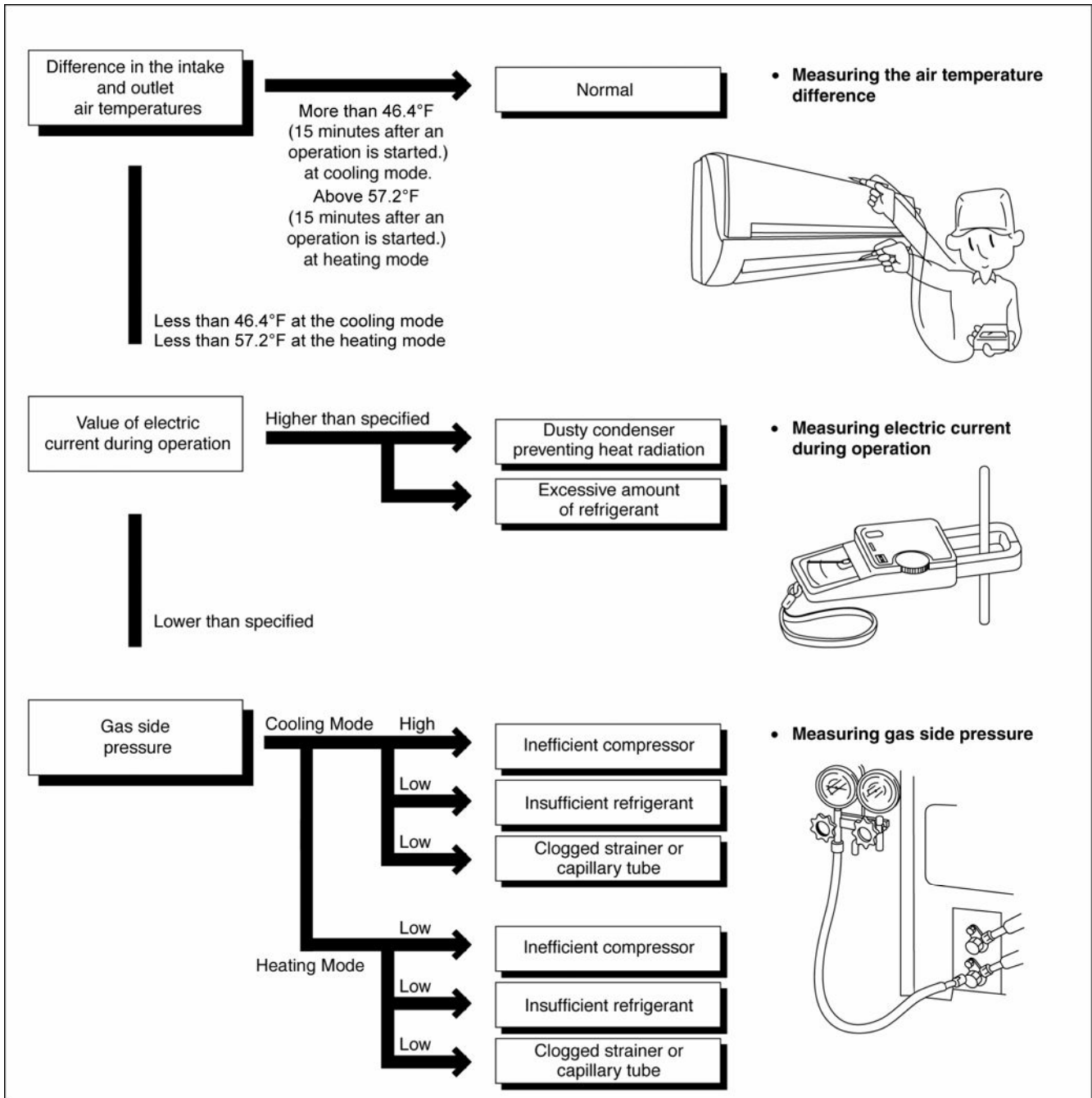

16.1.1 Relationship between the condition of the air conditioner and pressure and electric current

Condition of the air conditioner	Cooling Mode			Heating Mode		
	Low Pressure	High Pressure	Electric current during operating	Low Pressure	High Pressure	Electric current during operating
Insufficient refrigerant (gas leakage)	↘	↘	↘	↘	↘	↘
Clogged capillary tube or Strainer	↘	↘	↘	↗	↗	↗
Short circuit in the indoor unit	↘	↘	↘	↗	↗	↗
Heat radiation deficiency of the outdoor unit	↗	↗	↗	↘	↘	↘
Inefficient compression	↗	↘	↘	↗	↘	↘

- Carry out the measurements of pressure, electric current, and temperature fifteen minutes after an operation is started.

16.2 Breakdown Self Diagnosis Function

16.2.1 Self Diagnosis Function (Three Digits Alphanumeric Code)

- Once error occurred during operation, the unit will stop its operation, and Timer LED blinks.
- Although Timer LED goes off when power supply is turned off, if the unit is operated under a breakdown condition, the LED will ON again.
- In operation after breakdown repair, the Timer LED will not blink. The last error code (abnormality) will be stored in IC memory.

16.2.2 To Make a Diagnosis

- 1 Timer LED starts to blink and the unit automatically stops the operation.
- 2 Press the CHECK button on the remote control continuously for 5 seconds.
- 3 “- -” will be displayed on the remote control display.
Note: Display only for “- -” (No signal transmission, no receiving sound and no Power LED blinking)
- 4 Press the TIMER ▲ or ▼ button on the remote control. The code “H00” (no abnormality) will be displayed and signal will be transmit to the main unit.
- 5 Each press of the button (▲ or ▼) will increase error code number and transmit error code signal to the main unit.
- 6 When the latest abnormality code on the main unit and code transmitted from the remote control are matched, Power LED will light up for 30 seconds and a “beep” sound (continuously for 4 seconds) will be heard. If no codes are matched, Power LED will light up for 0.5 seconds and no sound will be heard.
- 7 The breakdown diagnosis mode will be canceled unless pressing the CHECK button continuously for 5 seconds or operating the unit for 30 seconds.
- 8 The LED will be off if the unit is turned off or the RESET button on the main unit is pressed.



16.2.3 To Display Memorized Error Code (Protective Operation)

- 1 Turn power on.
- 2 Press the CHECK button on the remote control
- 3 “- -” will be displayed on the remote control display.
Note: Display only for “- -” (No signal transmission, no receiving sound and no Power LED blinking)
- 4 Press the TIMER ▲ or ▼ button on the remote control. The code “H00” (no abnormality) will be displayed and signal will be transmit to the main unit.
- 5 Each press of the button (▲ or ▼) will increase error code number and transmit error code signal to the main unit.
- 6 When the latest abnormality code on the main unit and code transmitted from the remote control are matched, Power LED will light up for 30 seconds and a “beep” sound (continuously for 4 seconds) will be heard. If no codes are matched, Power LED will light up for 0.5 seconds and no sound will be heard.
- 7 The breakdown diagnosis mode will be canceled unless pressing the CHECK button continuously for 5 seconds or operating the unit for 30 seconds.
- 8 The same diagnosis can be repeated by turning power on again.

16.2.4 To Clear Memorized Error Code after Repair (Protective Operation)

- 1 Turn power on (in standby condition).
- 2 Press the AUTO button for 5 seconds (a “beep” sound is heard) on the main unit to operate the unit at Forced Cooling Operation Mode.
- 3 Press the CHECK button on the remote control for about 1 second with a pointed object to transmit signal to main unit. A “beep” sound is heard, and the Error Code is cleared.

16.2.5 Temporary Operation (Depending On Breakdown Status)

- 1 Press the Auto OFF/ON button on the main unit (a “beep” sound is heard) to operate the unit. (Remote control is enable again).
- 2 The unit can be temporarily be used until repaired.

Error Code	Operation	Temporary items
H23	Cooling	Emergency Operation with limited power
H27, H28	Cooling, Heating	

16.3 Error Code Table

Diagnosis display	Abnormality / Protection control	Abnormality Judgement	Protection operation	Problem	Check location
H00	No memory of failure	—	Normal operation	—	—
H11	Indoor/outdoor abnormal communication	After operation for 1 minute	Indoor fan only operation can start by entering into force cooling operation	Indoor/outdoor communication not establish	<ul style="list-style-type: none"> Indoor/outdoor wire terminal Indoor/outdoor PCB Indoor/outdoor connection wire
H12	Indoor unit capacity unmatched	90s after power supply	—	Total indoor capability more than maximum limit or less than minimum limit, or number of indoor unit less than two.	<ul style="list-style-type: none"> Indoor/outdoor connection wire Indoor/outdoor PCB Specification and combination table in catalogue
H14	Indoor intake air temperature sensor abnormality	Continuous for 5s	—	Indoor intake air temperature sensor open or short circuit	<ul style="list-style-type: none"> Indoor intake air temperature sensor lead wire and connector
H15	Compressor temperature sensor abnormality	Continuous for 5s	—	Compressor temperature sensor open or short circuit	<ul style="list-style-type: none"> Compressor temperature sensor lead wire and connector
H16	Outdoor current transformer (CT) abnormality	—	—	Current transformer faulty or compressor faulty	<ul style="list-style-type: none"> Outdoor PCB faulty or compressor faulty
H19	Indoor fan motor mechanism lock	Continuous happen for 7 times	—	Indoor fan motor lock or feedback abnormal	<ul style="list-style-type: none"> Fan motor lead wire and connector Fan motor lock or block
H23	Indoor heat exchanger temperature sensor abnormality	Continuous for 5s	—	Indoor heat exchanger temperature sensor open or short circuit	<ul style="list-style-type: none"> Indoor heat exchanger temperature sensor lead wire and connector
H27	Outdoor air temperature sensor abnormality	Continuous for 5s	—	Outdoor air temperature sensor open or short circuit	<ul style="list-style-type: none"> Outdoor air temperature sensor lead wire and connector
H28	Outdoor heat exchanger temperature sensor 1 abnormality	Continuous for 5s	—	Outdoor heat exchanger temperature sensor 1 open or short circuit	<ul style="list-style-type: none"> Outdoor heat exchanger temperature sensor 1 lead wire and connector
H30	Outdoor discharge pipe temperature sensor abnormality	Continuous for 5s	—	Outdoor discharge pipe temperature sensor open or short circuit	<ul style="list-style-type: none"> Outdoor discharge pipe temperature sensor lead wire and connector
H32	Outdoor heat exchanger temperature sensor 2 abnormality	Continuous for 5s	—	Outdoor heat exchanger temperature sensor 2 open or short circuit	<ul style="list-style-type: none"> Outdoor heat exchanger temperature sensor 2 lead wire and connector
H33	Indoor / outdoor misconnection abnormality	—	—	Indoor and outdoor rated voltage different	<ul style="list-style-type: none"> Indoor and outdoor units check
H36	Outdoor gas pipe temperature sensor abnormality	Continuous for 5s	Heating protection operation only	Outdoor gas pipe temperature sensor open or short circuit	<ul style="list-style-type: none"> Outdoor gas pipe temperature sensor lead wire and connector
H37	Outdoor liquid pipe temperature sensor abnormality	Continuous for 5s	Cooling protection operation only	Outdoor liquid pipe temperature sensor open or short circuit	<ul style="list-style-type: none"> Outdoor liquid pipe temperature sensor lead wire and connector
H38	Indoor/Outdoor mismatch (brand code)	—	—	Brand code not match	<ul style="list-style-type: none"> Check indoor unit and outdoor unit.
H64	Outdoor high pressure sensor abnormality	Continuous for 1 minutes	—	High pressure sensor open circuit during compressor stop	<ul style="list-style-type: none"> High pressure sensor Lead wire and connector
H97	Outdoor fan motor mechanism lock	2 times happen within 30 minutes	—	Outdoor fan motor lock or feedback abnormal	<ul style="list-style-type: none"> Outdoor fan motor lead wire and connector Fan motor lock or block
H98	Indoor high pressure protection	—	—	Indoor high pressure protection (Heating)	<ul style="list-style-type: none"> Check indoor heat exchanger Air filter dirty Air circulation short circuit

Diagnosis display	Abnormality / Protection control	Abnormality Judgement	Protection operation	Problem	Check location
H99	Indoor operating unit freeze protection	—	—	Indoor freeze protection (Cooling)	<ul style="list-style-type: none"> • Check indoor heat exchanger • Air filter dirty • Air circulation short circuit
F11	4-way valve switching abnormality	4 times happen within 30 minutes	—	4-way valve switching abnormal	<ul style="list-style-type: none"> • 4-way valve • Lead wire and connector.
F17	Indoor standby units freezing abnormality	3 times happen within 40 minutes	—	Wrong wiring and connecting pipe, expansion valve leakage, indoor heat exchanger sensor open circuit	<ul style="list-style-type: none"> • Check indoor/outdoor connection wire and pipe • Indoor heat exchanger sensor lead wire and connector • Expansion valve lead wire and connector.
F90	Power factor correction (PFC) circuit protection	4 times happen within 10 minutes	—	Power factor correction circuit abnormal	<ul style="list-style-type: none"> • Outdoor PCB faulty
F91	Refrigeration cycle abnormality	2 times happen within 20 minutes	—	Refrigeration cycle abnormal	<ul style="list-style-type: none"> • Insufficient refrigerant or valve close
F93	Compressor abnormal revolution	4 times happen within 20 minutes	—	Compressor abnormal revolution	<ul style="list-style-type: none"> • Power transistor module faulty or compressor lock
F95	Outdoor cooling high pressure protection	4 times happen within 20 minutes	—	Cooling high pressure protection	<ul style="list-style-type: none"> • Check refrigeration system • Outdoor air circuit
F96	Power transistor module overheating protection	4 times happen within 30 minutes	—	Power transistor module overheat	<ul style="list-style-type: none"> • PCB faulty • Outdoor air circuit (fan motor)
F97	Compressor overheating protection	3 times happen within 30 minutes	—	Compressor overheat	<ul style="list-style-type: none"> • Insufficient refrigerant
F98	Total running current protection	3 times happen within 20 minutes	—	Total current protection	<ul style="list-style-type: none"> • Check refrigeration system • Power source or compressor lock
F99	Outdoor direct current (DC) peak detection	Continuous happen for 7 times	—	Power transistor module current protection	<ul style="list-style-type: none"> • Power transistor module faulty or compressor lock

Note:

“o” – Frequency measured and fan speed fixed

The memory data of error code is erased when the power supply is cut off, or press the Auto Switch until “beep” sound heard following by pressing the CHECK button at remote control.

Although operation forced to stop when abnormality detected, emergency operation is possible for certain errors (refer to Error Code Table) by using remote control or Auto OFF/ON button at indoor unit. However, the remote control signal receiving sound is changed from one “beep” to four “beep” sounds.

16.4 Self-diagnosis Method

16.4.1 H11 (Indoor/Outdoor Abnormal Communication)

Malfunction Decision Conditions

- During startup and operation of cooling and heating, the data received from outdoor unit in indoor unit signal transmission is checked whether it is normal.

Malfunction Caused

- Faulty indoor unit PCB.
- Faulty outdoor unit PCB.
- Indoor unit-outdoor unit signal transmission error due to wrong wiring.
- Indoor unit-outdoor unit signal transmission error due to breaking of wire in the connection wires between the indoor and outdoor units.
- Indoor unit-outdoor unit signal transmission error due to disturbed power supply waveform.

Troubleshooting

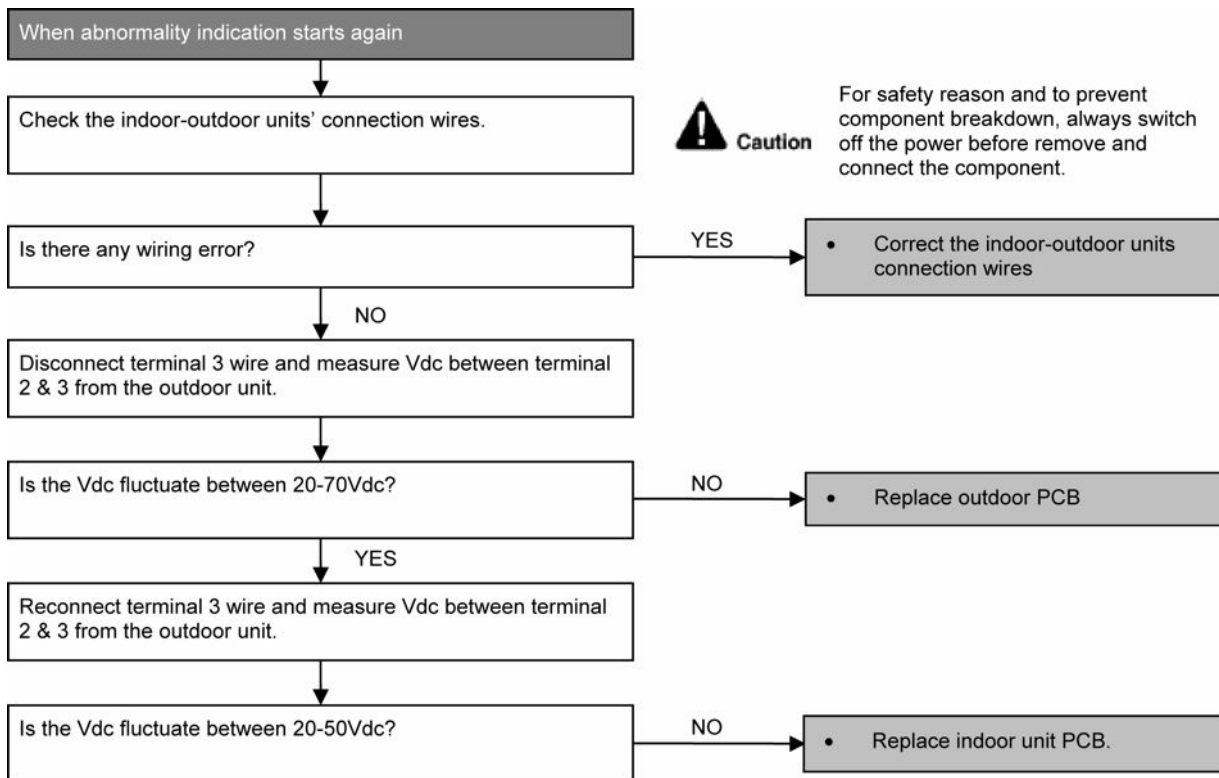

16.4.2 H12 (Indoor/Outdoor Capacity Rank Mismatched)

Malfunction Decision Conditions

- During startup, error code appears when different types of indoor and outdoor units are interconnected.

Malfunction Caused

- Wrong models interconnected.
- Wrong indoor unit or outdoor unit PCBs mounted.
- Indoor unit or outdoor unit PCBs defective.
- Indoor-outdoor unit signal transmission error due to wrong wiring.
- Indoor-outdoor unit signal transmission error due to breaking of wire 3 in the connection wires between the indoor and outdoor units.

Troubleshooting

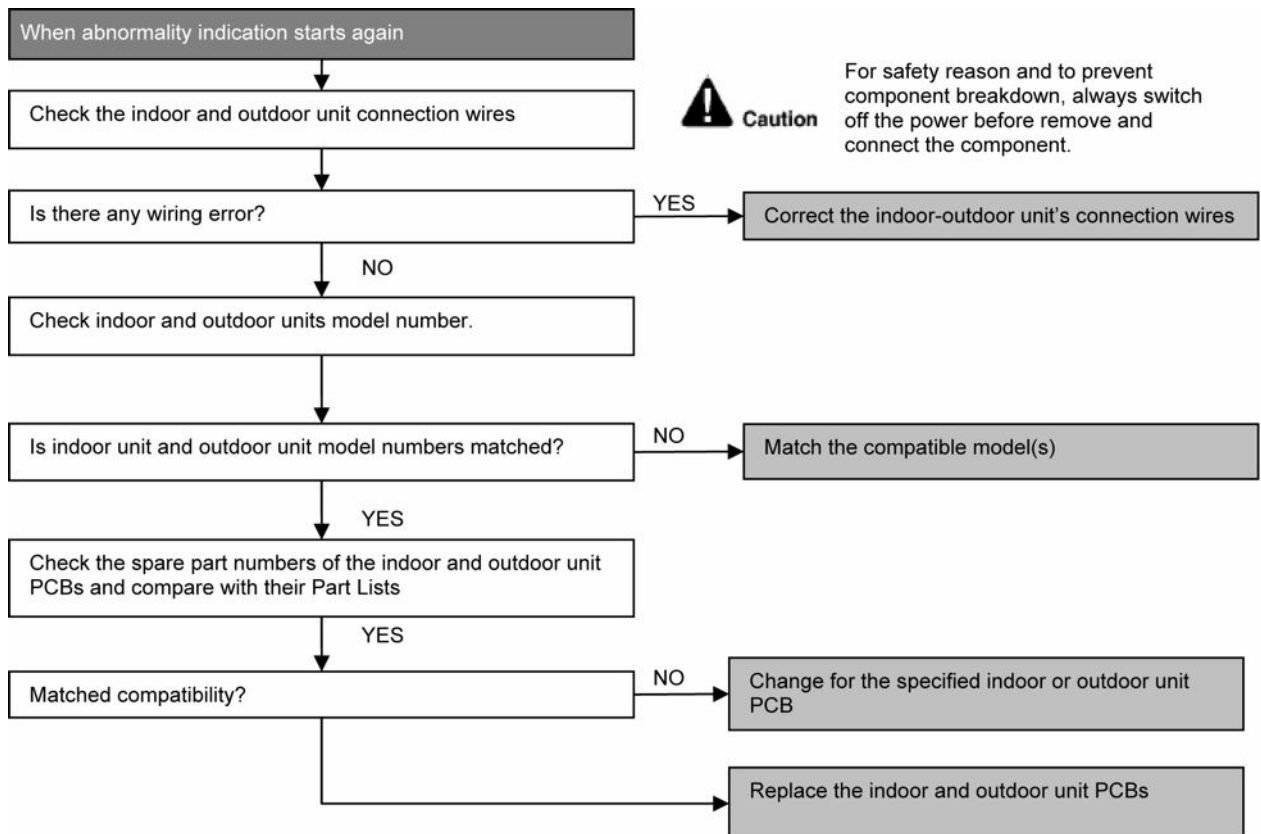

16.4.3 H14 (Indoor Intake Air Temperature Sensor Abnormality)

Malfunction Decision Conditions

- During startup and operation of cooling and heating, the temperatures detected by the indoor intake air temperature sensor are used to determine sensor errors.

Malfunction Caused

- Faulty connector connection.
- Faulty sensor.
- Faulty PCB.

Troubleshooting

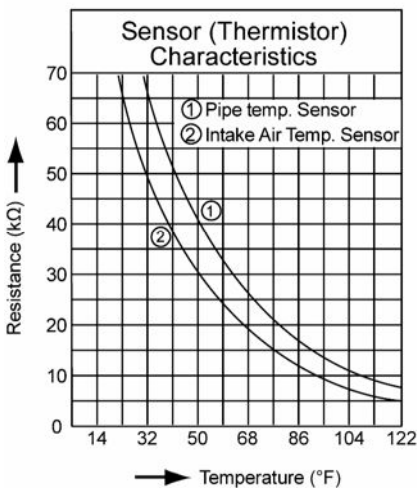
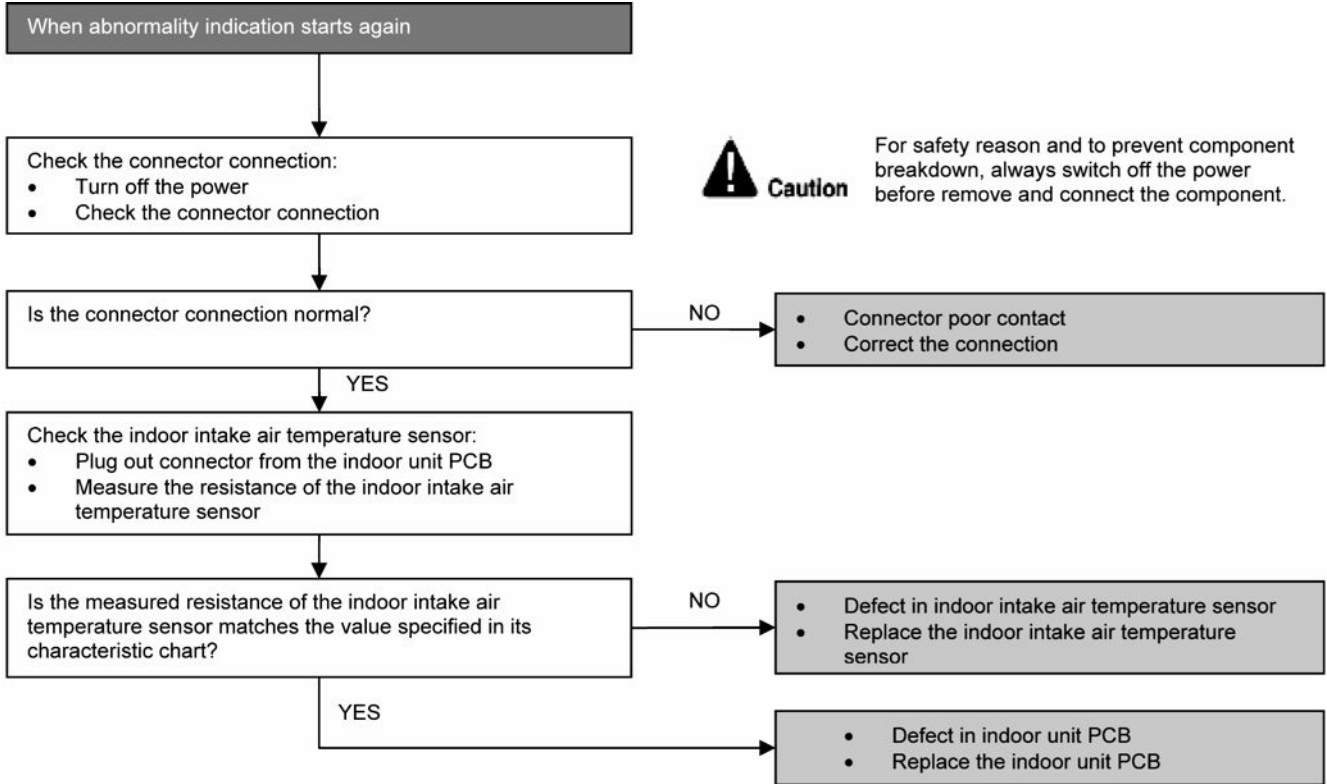

16.4.4 H15 (Compressor Temperature Sensor Abnormality)

Malfunction Decision Conditions

- During startup and operation of cooling and heating, the temperatures detected by the outdoor compressor temperature sensor are used to determine sensor errors.

Malfunction Caused

- Faulty connector connection.
- Faulty sensor.
- Faulty PCB.

Troubleshooting

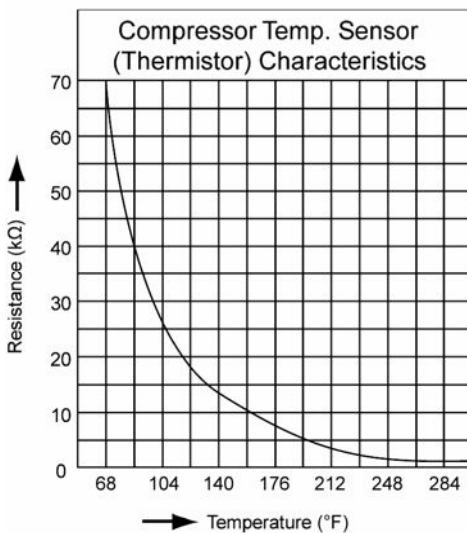
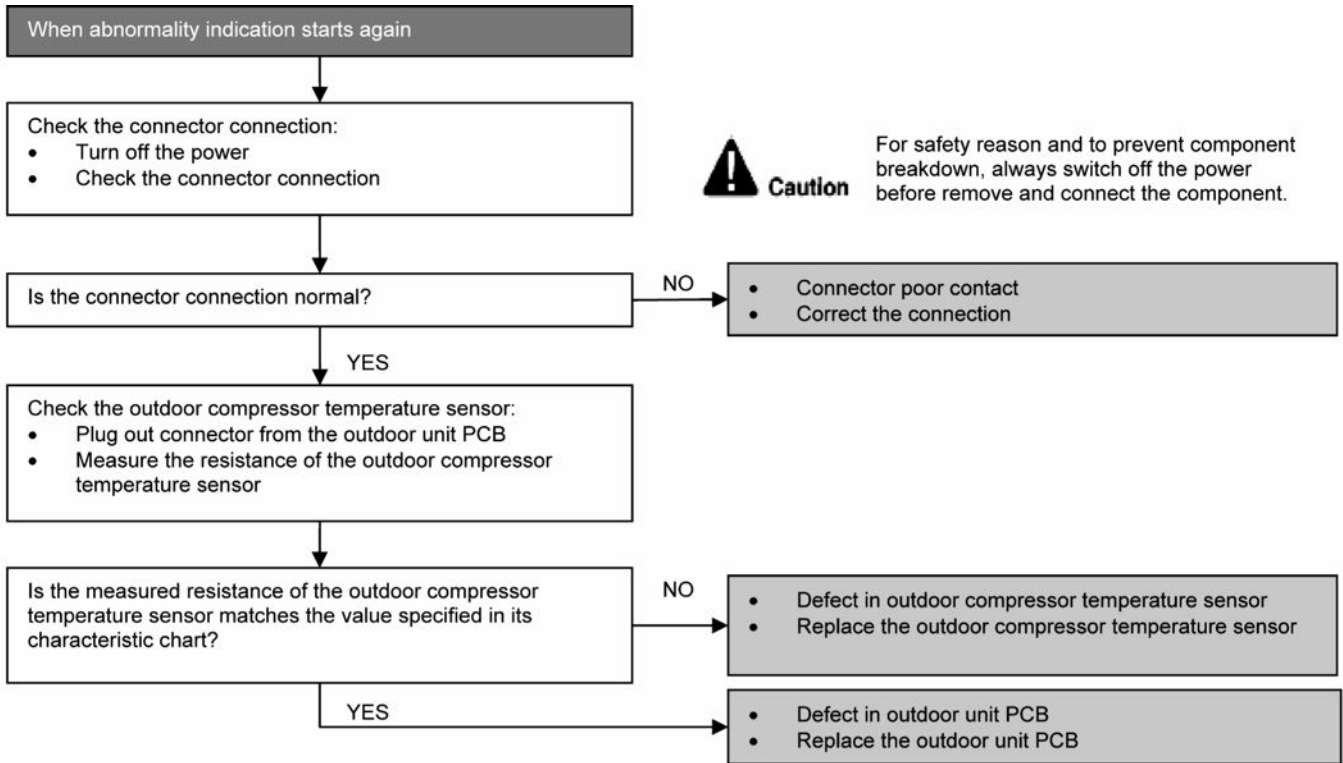

16.4.5 H16 (Outdoor Current Transformer Open Circuit)

Malfunction Decision Conditions

- A current transformer (CT) is detected by checking the compressor running frequency (\geq rated frequency) and CT detected input current (less than 0.65A) for continuously 20 seconds.

Malfunction Caused

- CT defective
- Outdoor PCB defective
- Compressor defective (low compression)

Troubleshooting

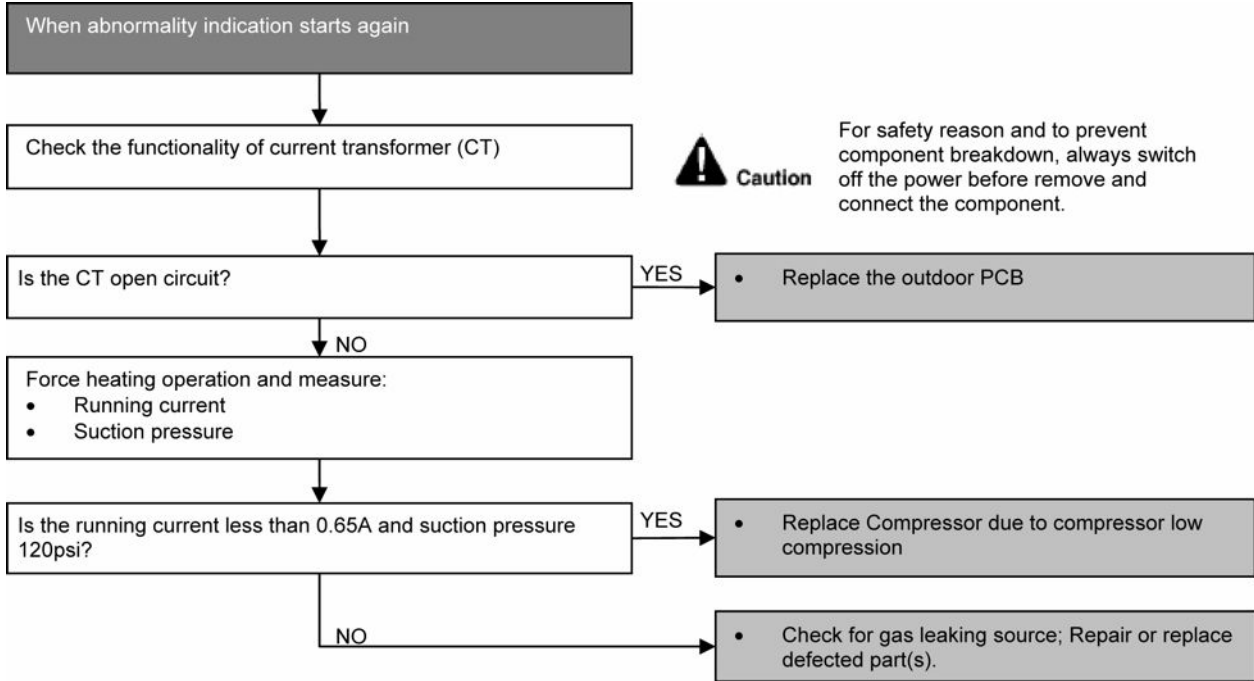

16.4.6 H19 (Indoor Fan Motor – DC Motor Mechanism Locked)

Malfunction Decision Conditions

- The rotation speed detected by the Hall IC during fan motor operation is used to determine abnormal fan motor (feedback of rotation > 2550rpm or < 50rpm)

Malfunction Caused

- Operation stops due to short circuit inside the fan motor winding.
- Operation stops due to breaking of wire inside the fan motor.
- Operation stops due to breaking of fan motor lead wires.
- Operation stops due to Hall IC malfunction.
- Operation error due to faulty indoor unit PCB.

Troubleshooting

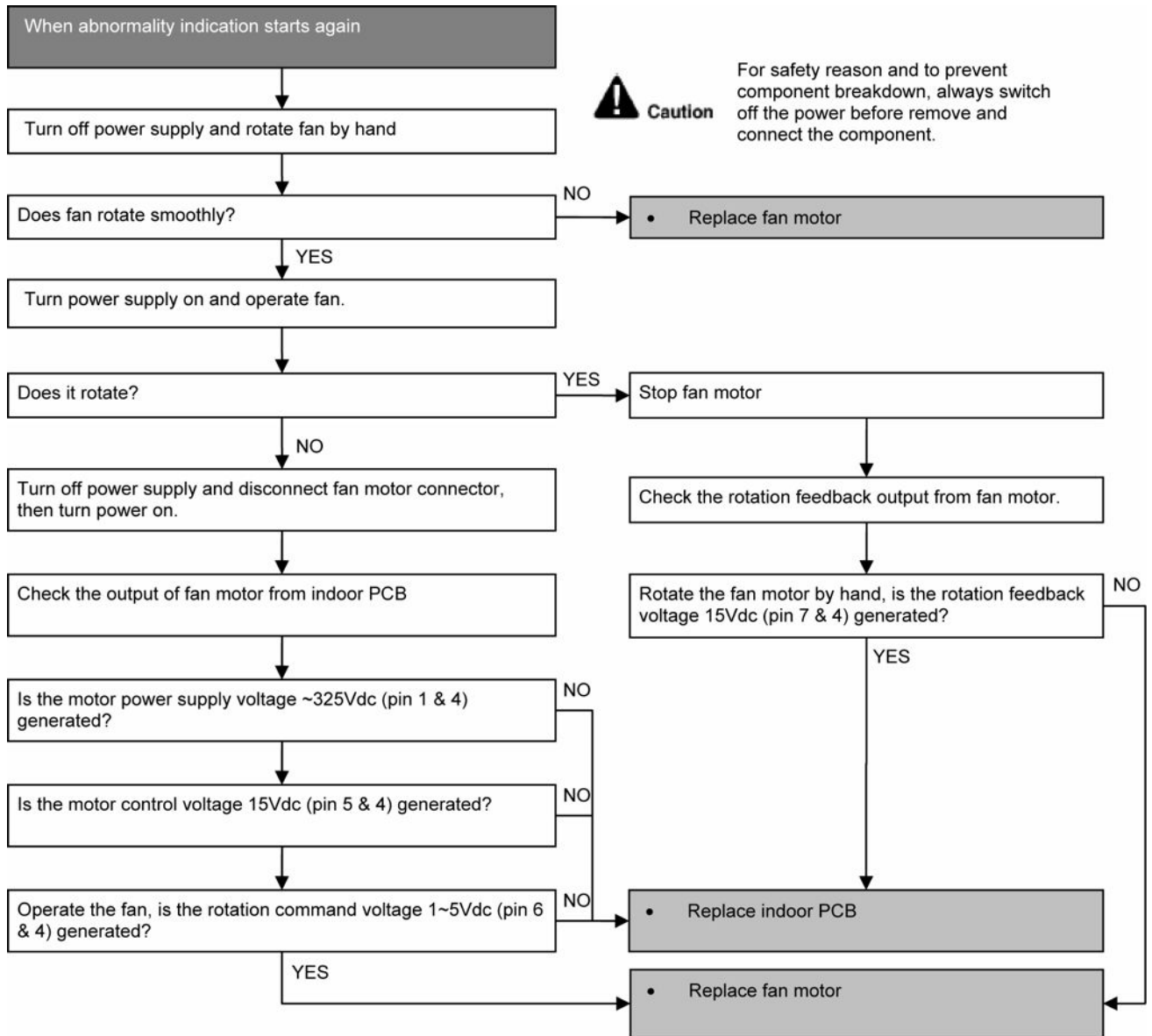

16.4.7 H23 (Indoor Pipe Temperature Sensor Abnormality)

Malfunction Decision Conditions

- During startup and operation of cooling and heating, the temperatures detected by the indoor heat exchanger temperature sensor are used to determine sensor errors.

Malfunction Caused

- Faulty connector connection.
- Faulty sensor.
- Faulty PCB.

Troubleshooting

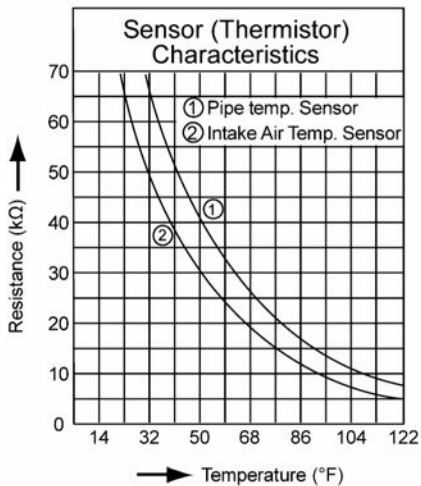
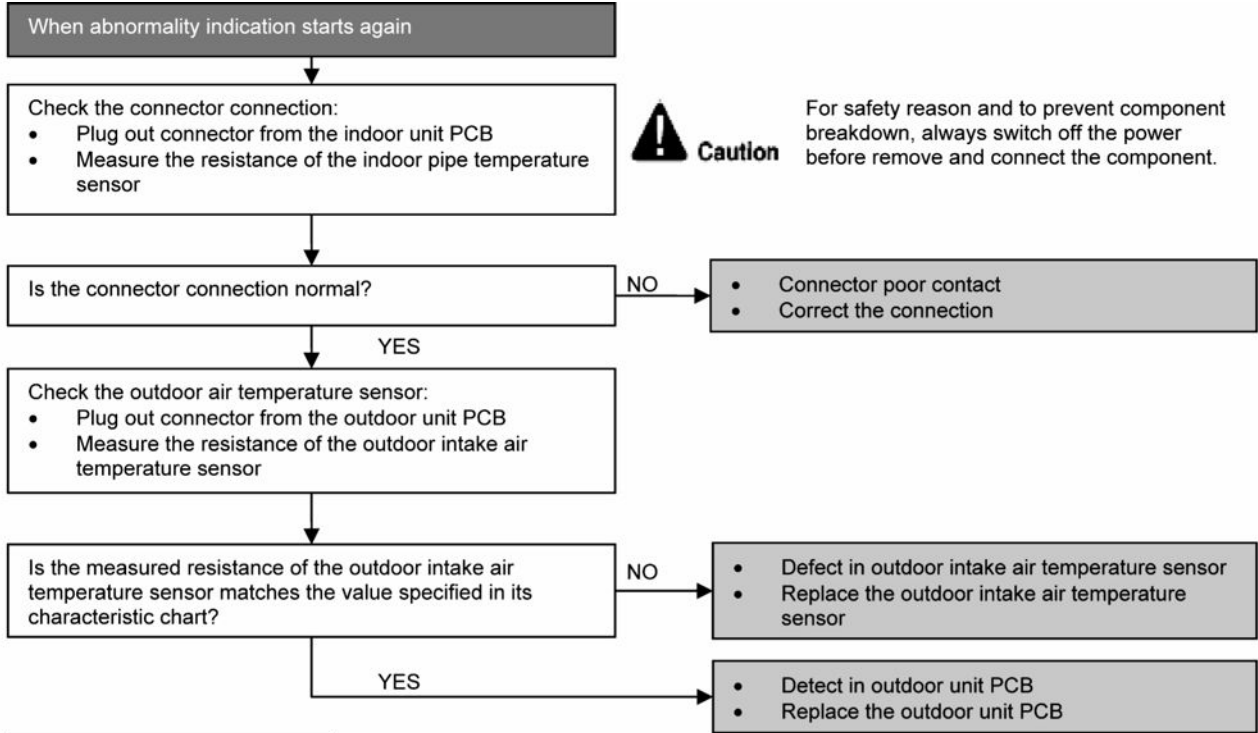

16.4.8 H27 (Outdoor Air Temperature Sensor Abnormality)

Malfunction Decision Conditions

- During startup and operation of cooling and heating, the temperatures detected by the outdoor air temperature sensor are used to determine sensor errors.

Malfunction Caused

- Faulty connector connection.
- Faulty sensor.
- Faulty PCB.

Troubleshooting

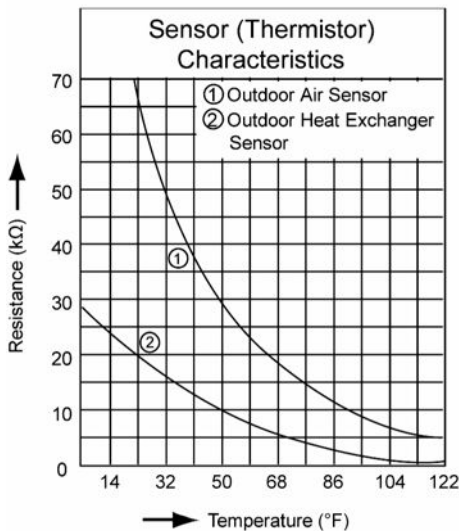
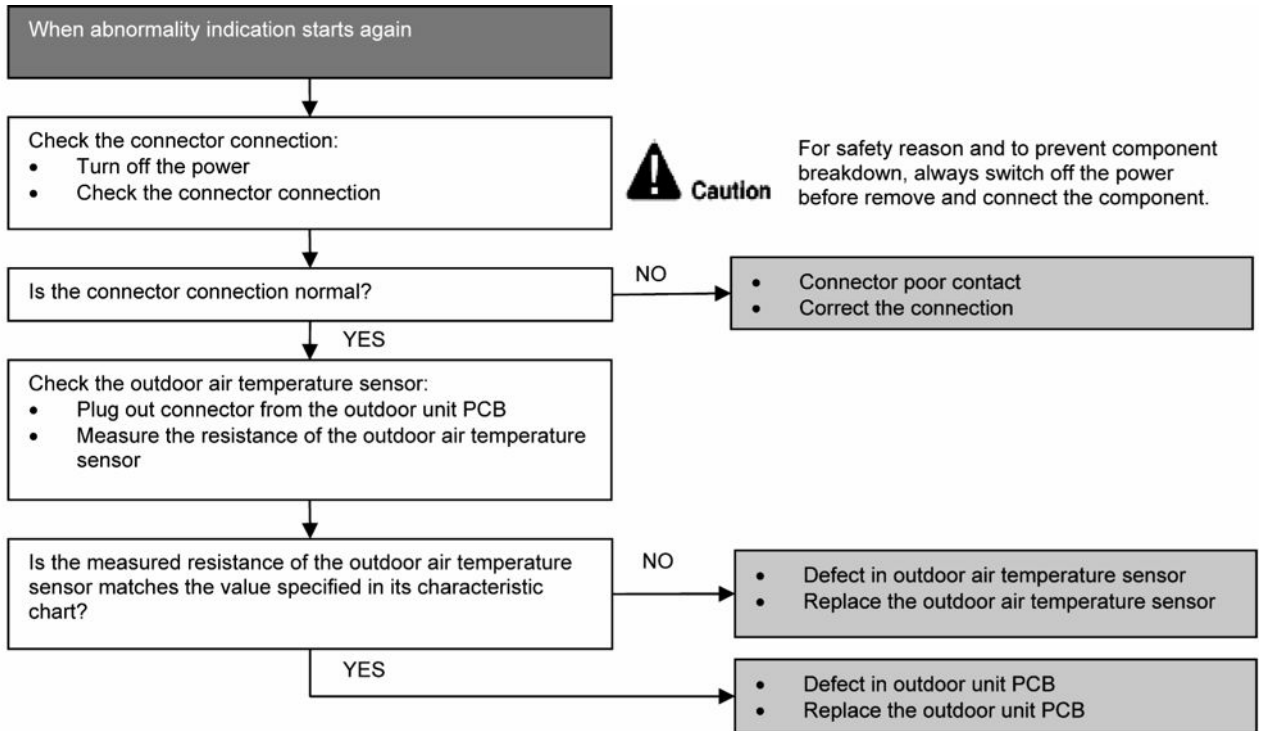

16.4.9 H28 (Outdoor Pipe Temperature Sensor Abnormality)

Malfunction Decision Conditions

- During startup and operation of cooling and heating, the temperatures detected by the outdoor pipe temperature sensor are used to determine sensor errors.

Malfunction Caused

- Faulty connector connection.
- Faulty sensor.
- Faulty PCB.

Troubleshooting

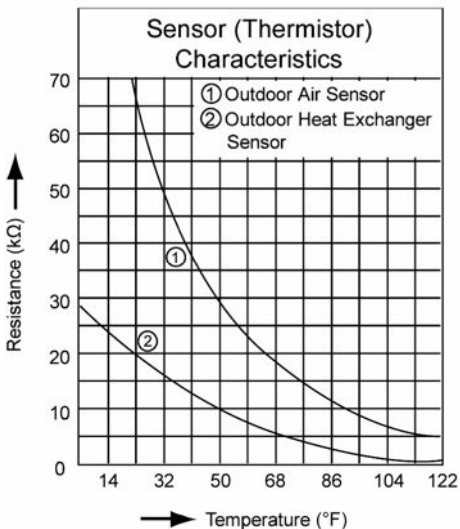
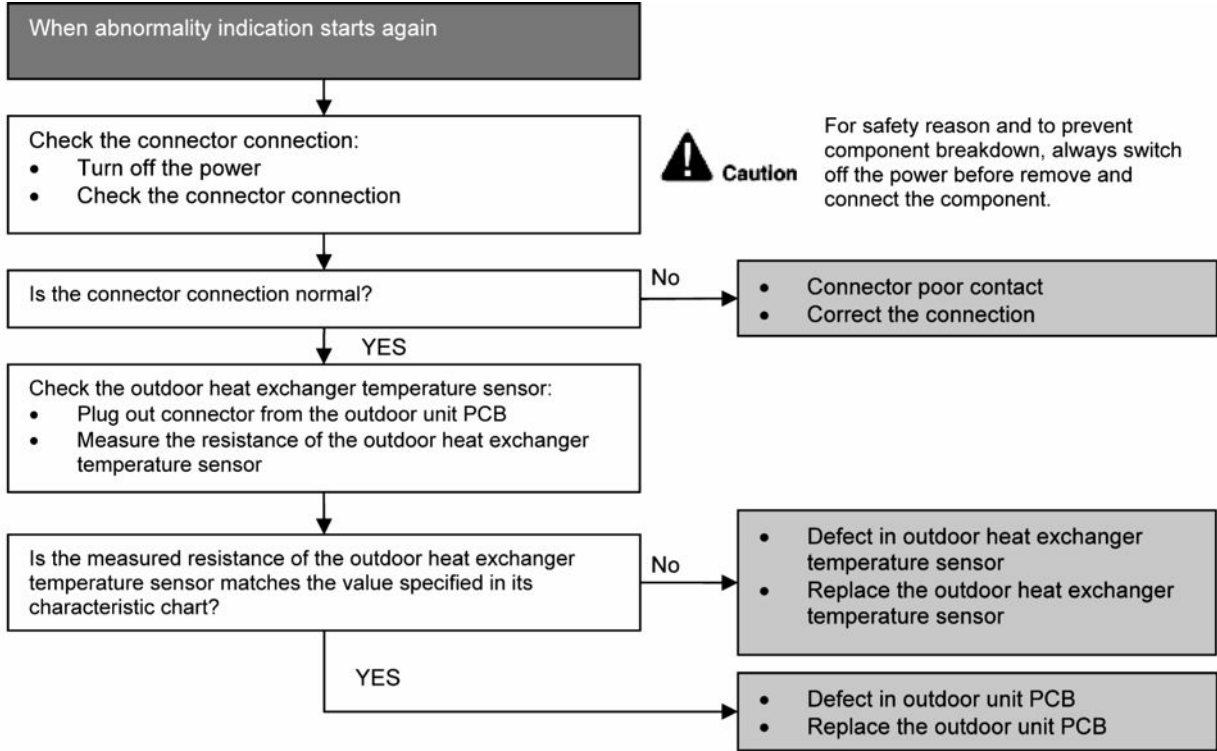

16.4.10 H30 (Compressor Discharge Temperature Sensor Abnormality)

Malfunction Decision Conditions

- During startup and operation of cooling and heating, the temperatures detected by the outdoor discharge pipe temperature sensor are used to determine sensor errors.

Malfunction Caused

- Faulty connector connection.
- Faulty sensor.
- Faulty PCB.

Troubleshooting

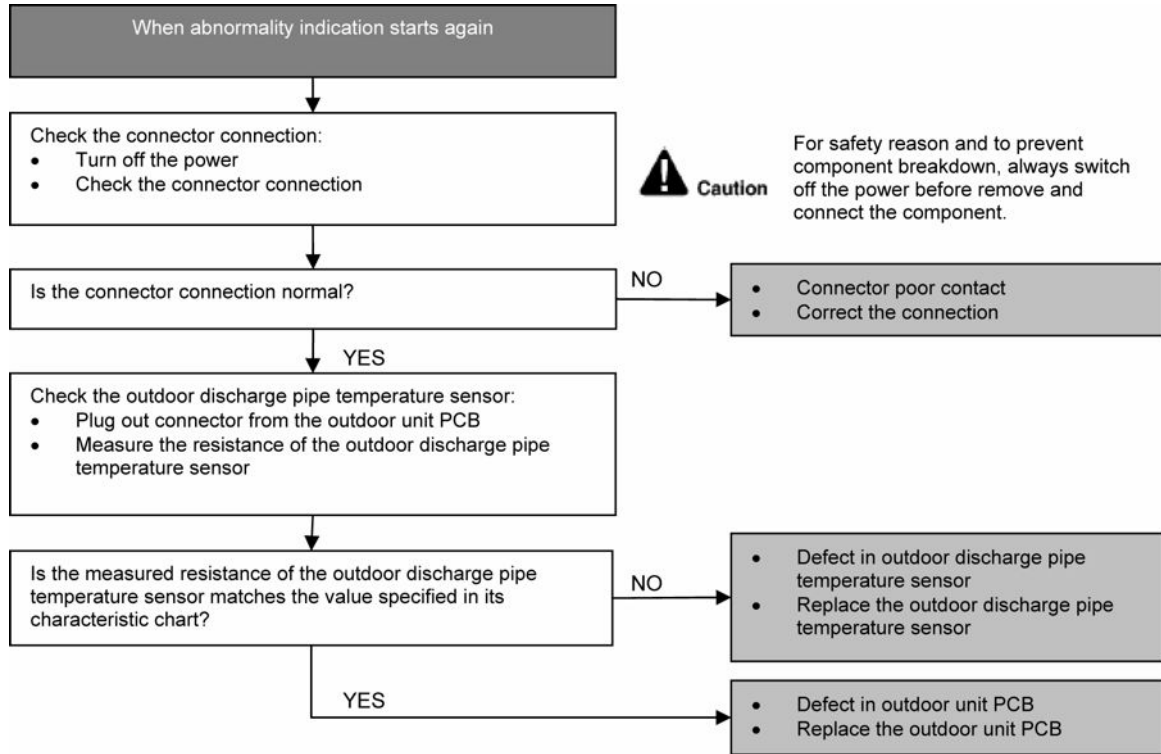

16.4.11 H32 (Outdoor Heat Exchanger Temperature Sensor 2 Abnormality)

Malfunction Decision Conditions

- During startup and operation of cooling and heating, the temperatures detected by the outdoor heat exchanger temperature sensor are used to determine sensor errors.

Malfunction Caused

- Faulty connector connection.
- Faulty sensor.
- Faulty PCB.

Troubleshooting

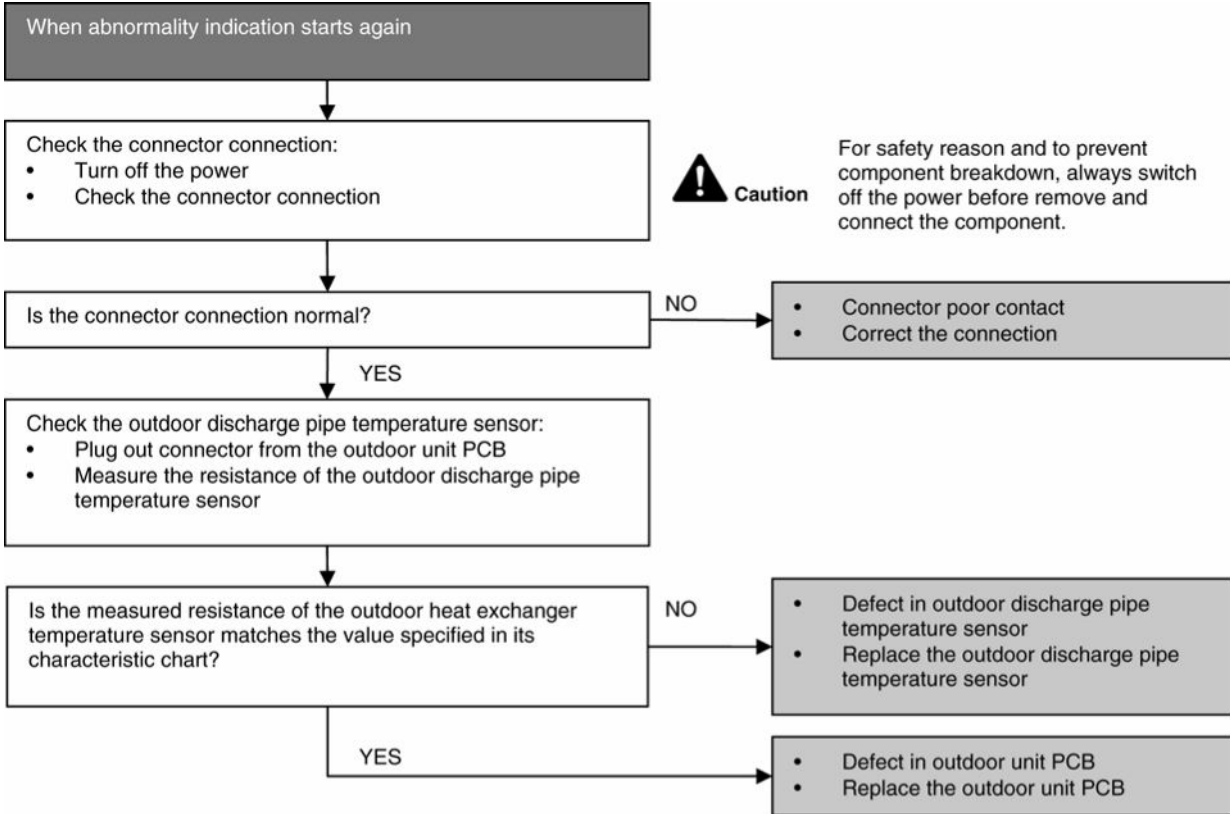

16.4.12 H33 (Unspecified Voltage between Indoor and Outdoor)

Malfunction Decision Conditions

- The supply power is detected for its requirement by the indoor/outdoor transmission.

Malfunction Caused

- Wrong models interconnected.
- Wrong indoor unit and outdoor unit PCBs used.
- Indoor unit or outdoor unit PCB defective.

Troubleshooting

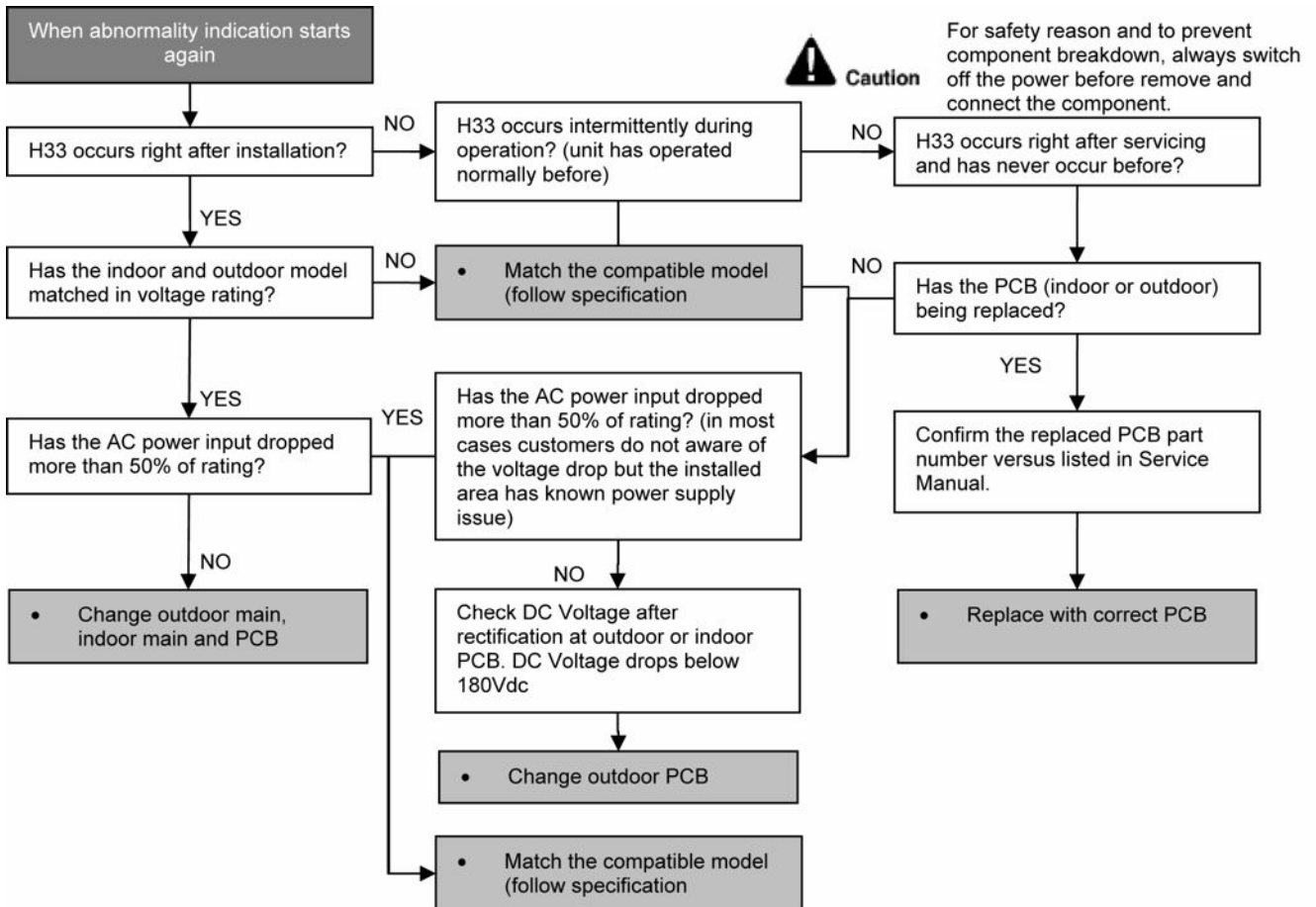

16.4.13 H36 (Outdoor Gas Pipe Sensor Abnormality)

Malfunction Decision Conditions

- During startup and operation of cooling and heating, the temperatures detected by the outdoor gas pipe temperature sensor are used to determine sensor errors.

Malfunction Caused

- Faulty connector connection.
- Faulty sensor.
- Faulty PCB.

Troubleshooting

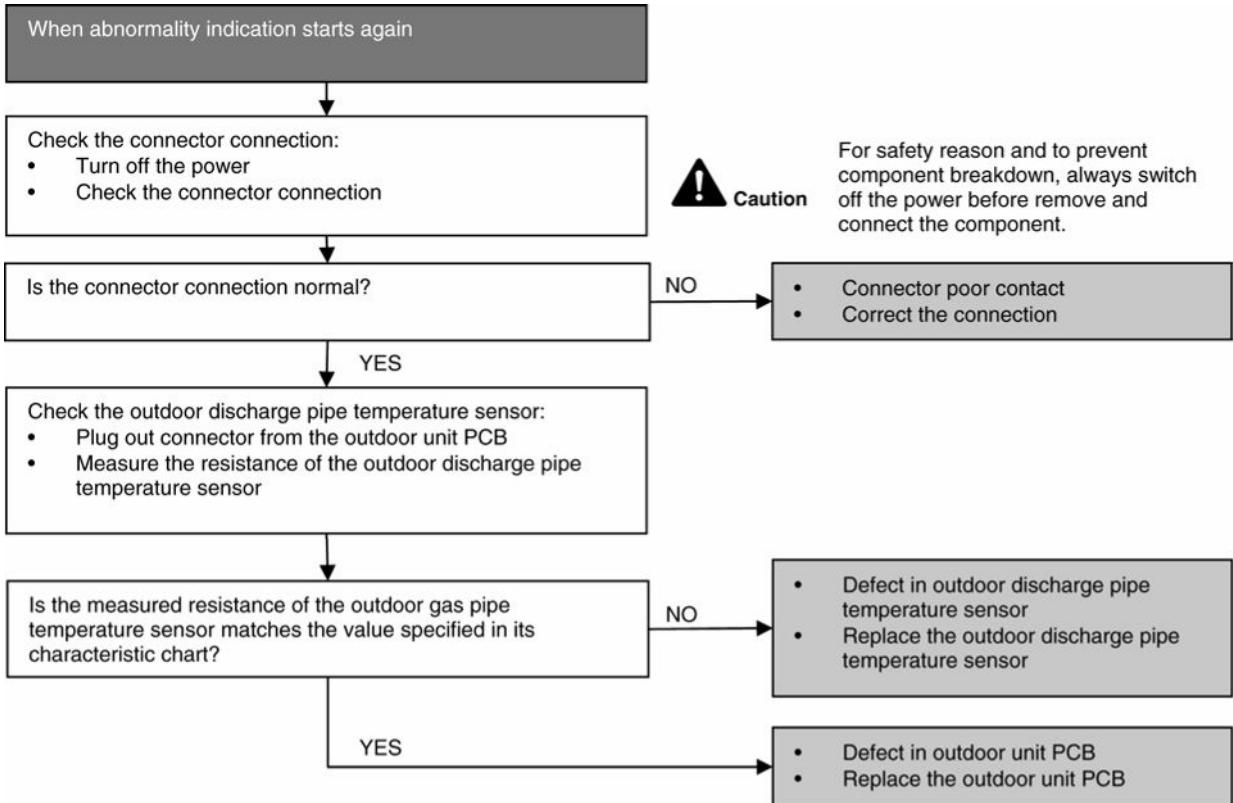

16.4.14 H37 (Outdoor Liquid Pipe Temperature Sensor Abnormality)

Malfunction Decision Conditions

- During startup and operation of cooling and heating, the temperatures detected by the outdoor liquid pipe temperature sensor are used to determine sensor errors.

Malfunction Caused

- Faulty connector connection.
- Faulty sensor.
- Faulty PCB.

Troubleshooting

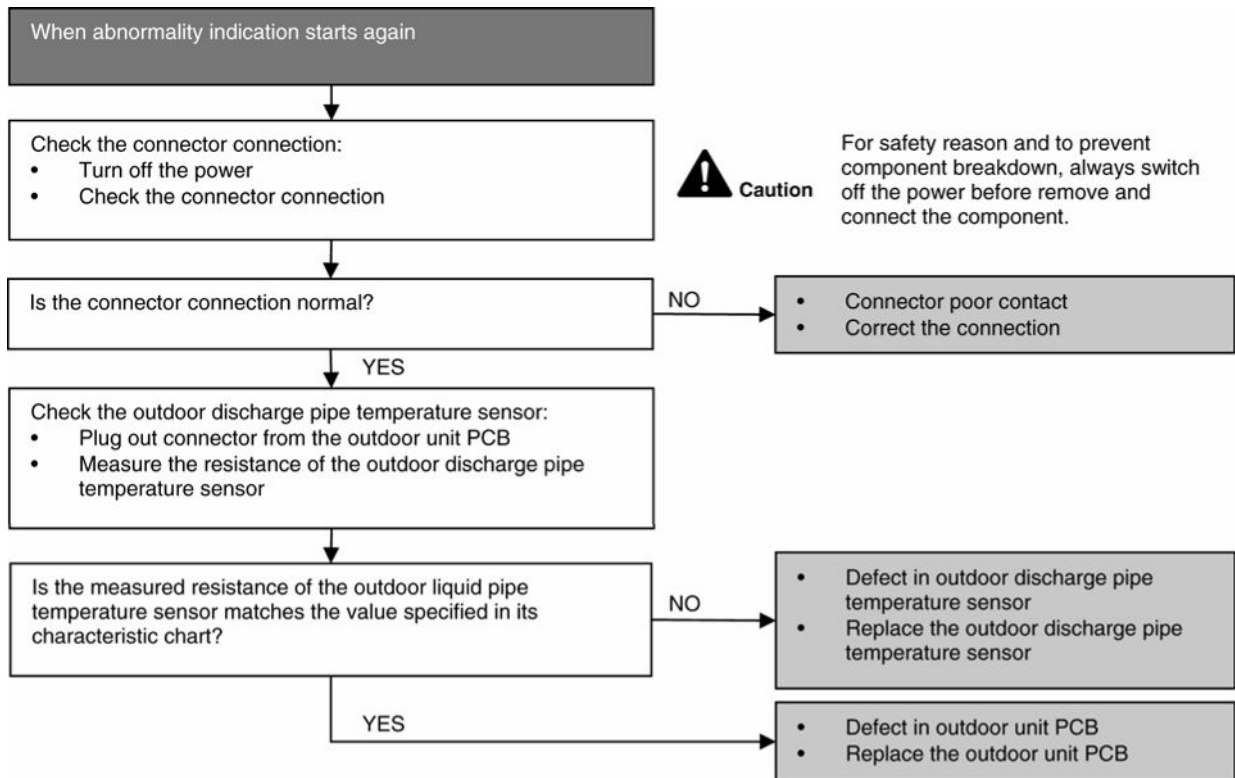

16.4.15 H97 (Outdoor Fan Motor – DC Motor Mechanism Locked)

Malfunction Decision Conditions

- The rotation speed detected by the Hall IC during fan motor operation is used to determine abnormal fan motor.

Malfunction Caused

- Operation stops due to short circuit inside the fan motor winding.
- Operation stops due to breaking of wire inside the fan motor.
- Operation stops due to breaking of fan motor lead wires.
- Operation stops due to Hall IC malfunction.
- Operation error due to faulty outdoor unit PCB.

Troubleshooting

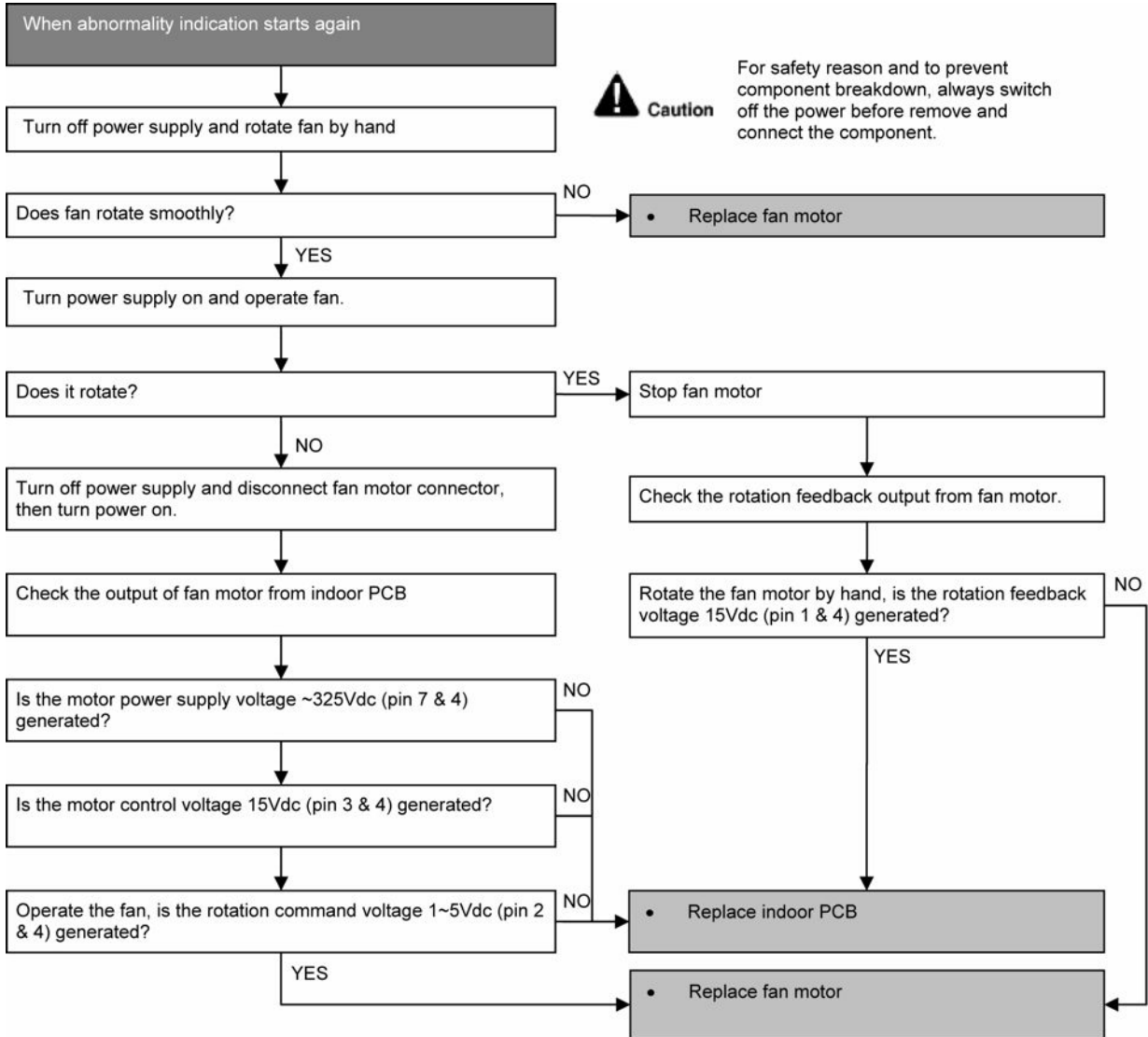

16.4.16 H98 (Indoor High Pressure Protection)

Error Code will not display (no Timer LED blinking) but store in EEPROM

Malfunction Decision Conditions

- During heating operation, the temperature detected by the indoor pipe temperature sensor is above 140°F.

Malfunction Caused

- Clogged air filter of the indoor unit
- Dust accumulation on the indoor unit heat exchanger
- Air short circuit
- Detection error due to faulty indoor pipe temperature sensor
- Detection error due to faulty indoor unit PCB

Troubleshooting

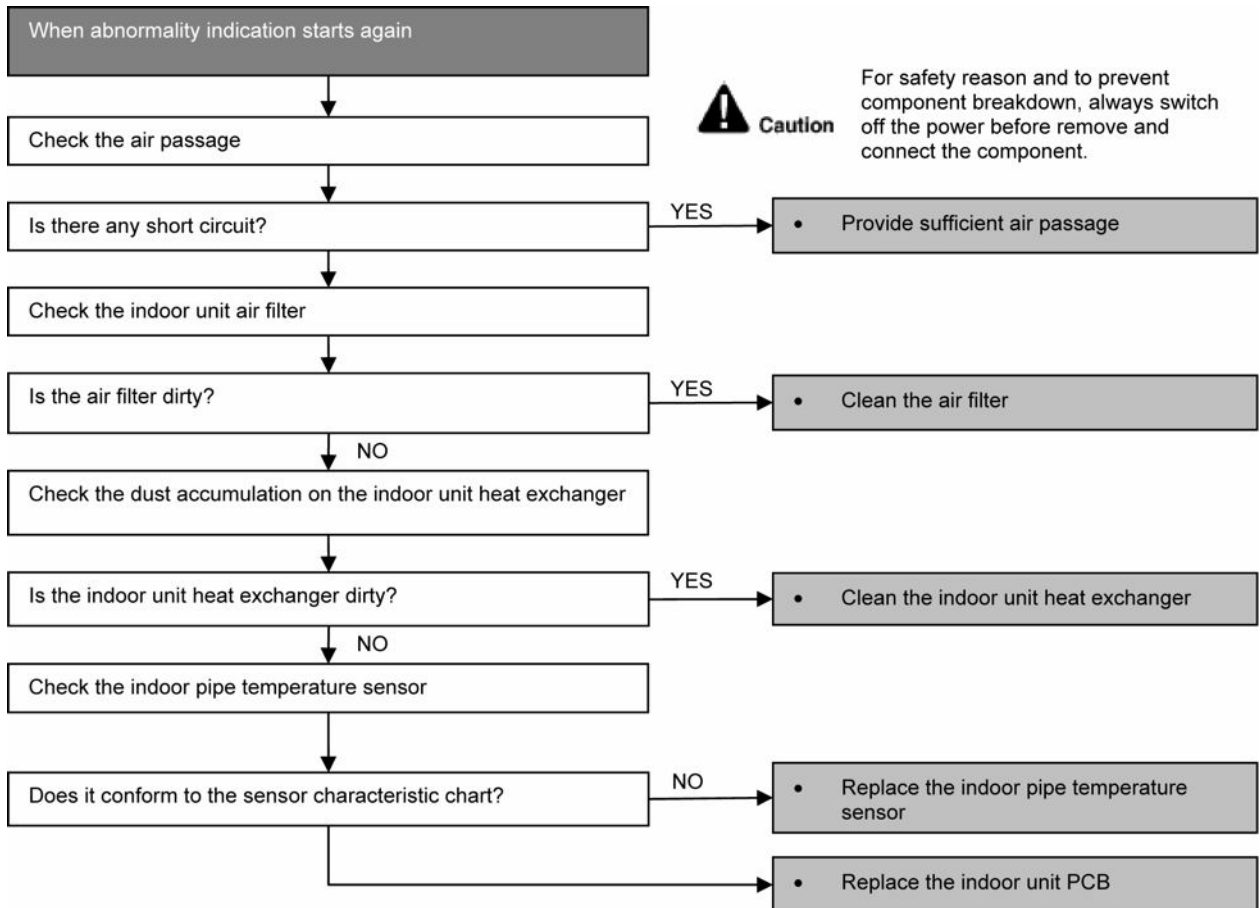

16.4.17 H99 (Indoor Freeze Prevention Protection: Cooling or Soft Dry)

Malfunction Decision Conditions

- Freeze prevention control takes place (when indoor pipe temperature is lower than 35.6°F)

Malfunction Caused

- Clogged air filter of the indoor unit
- Dust accumulation on the indoor unit heat exchanger
- Air short circuit
- Detection error due to faulty indoor pipe temperature sensor
- Detection error due to faulty indoor unit PCB

Troubleshooting

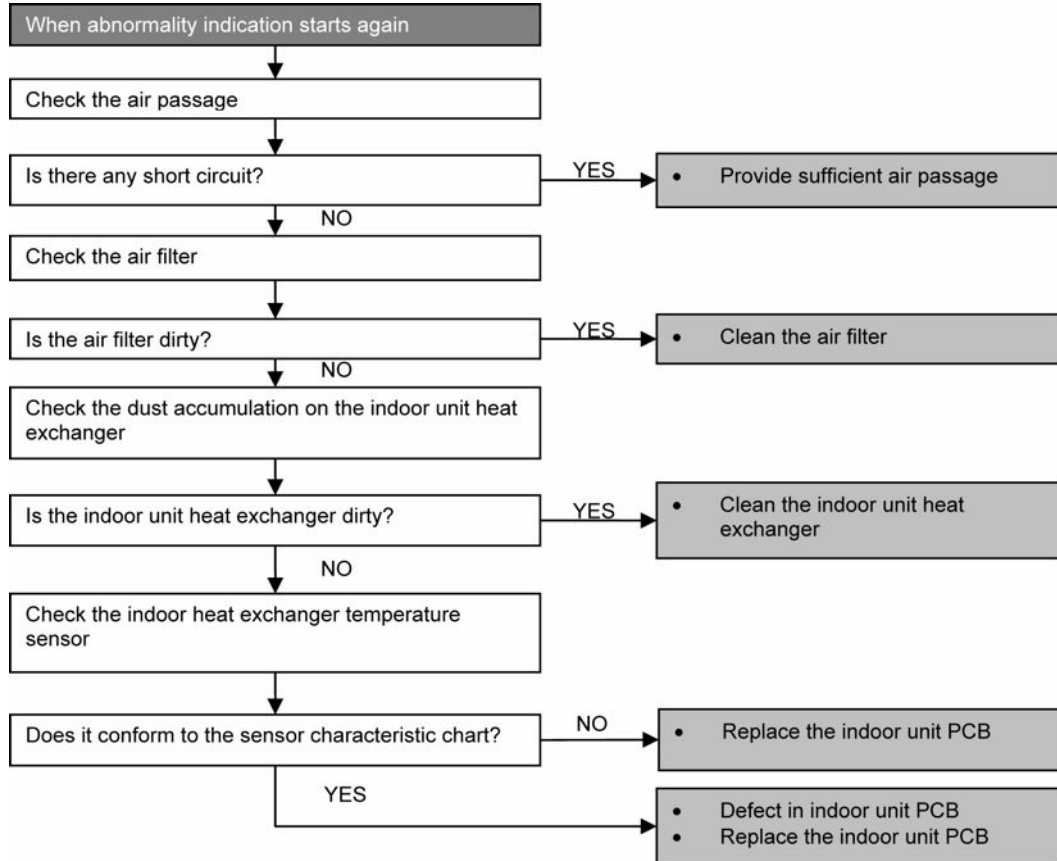

16.4.18 F11 (Indoor Pipe Temperature Sensor Abnormality)

Malfunction Decision Conditions

- When cooling operation, when indoor pipe temperature or indoor heat exchanger temperature sensor is above 113°F.

Malfunction Caused

- Faulty connector connection.
- Faulty indoor pipe temperature sensor.
- Faulty indoor main PCB.

Troubleshooting

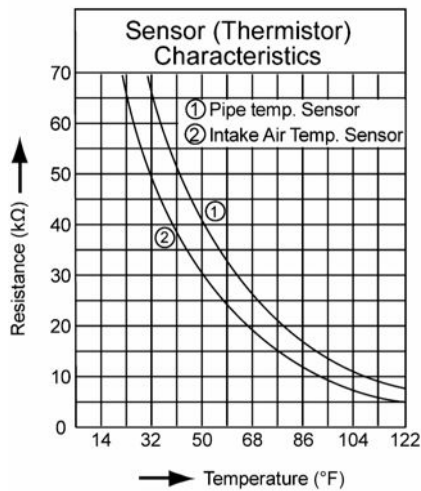
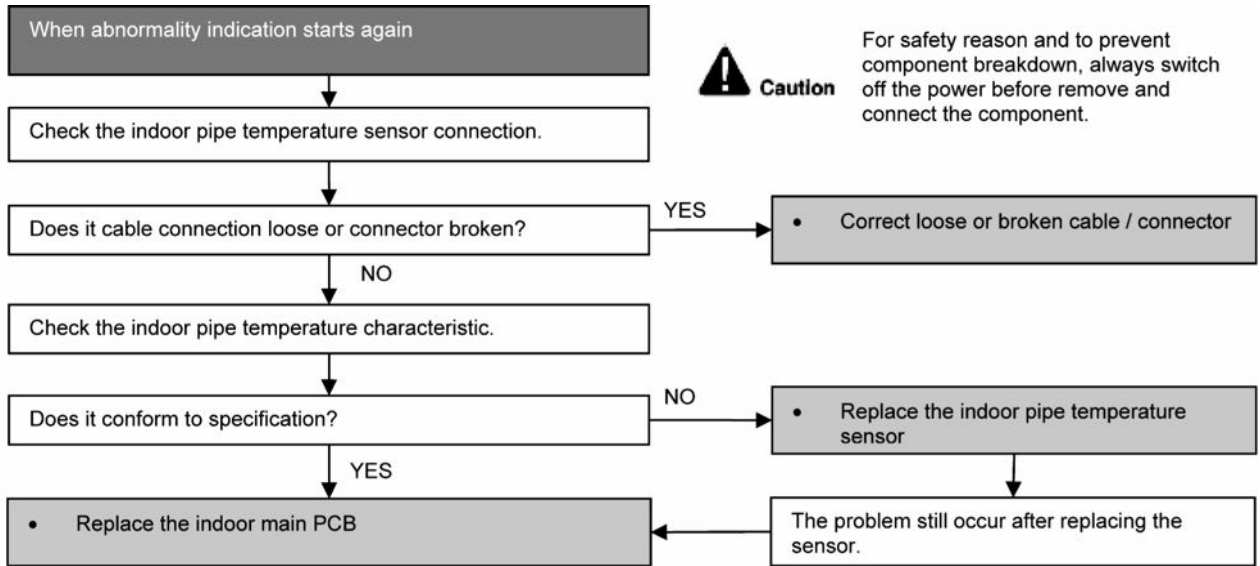

16.4.19 F17 (Indoor Standby Units Freezing Abnormality)

Malfunction Decision Conditions

- When the different between indoor intake air temperature and indoor pipe temperature is above 50°F or indoor pipe temperature is below 30.2°F

Remark:

When the indoor standby unit is freezing, the outdoor unit transfers F17 error code to the corresponding indoor unit and H39 to other indoor unit(s).

Malfunction Caused

- Wrong wiring connection
- Faulty sensor
- Faulty expansion valve

Troubleshooting

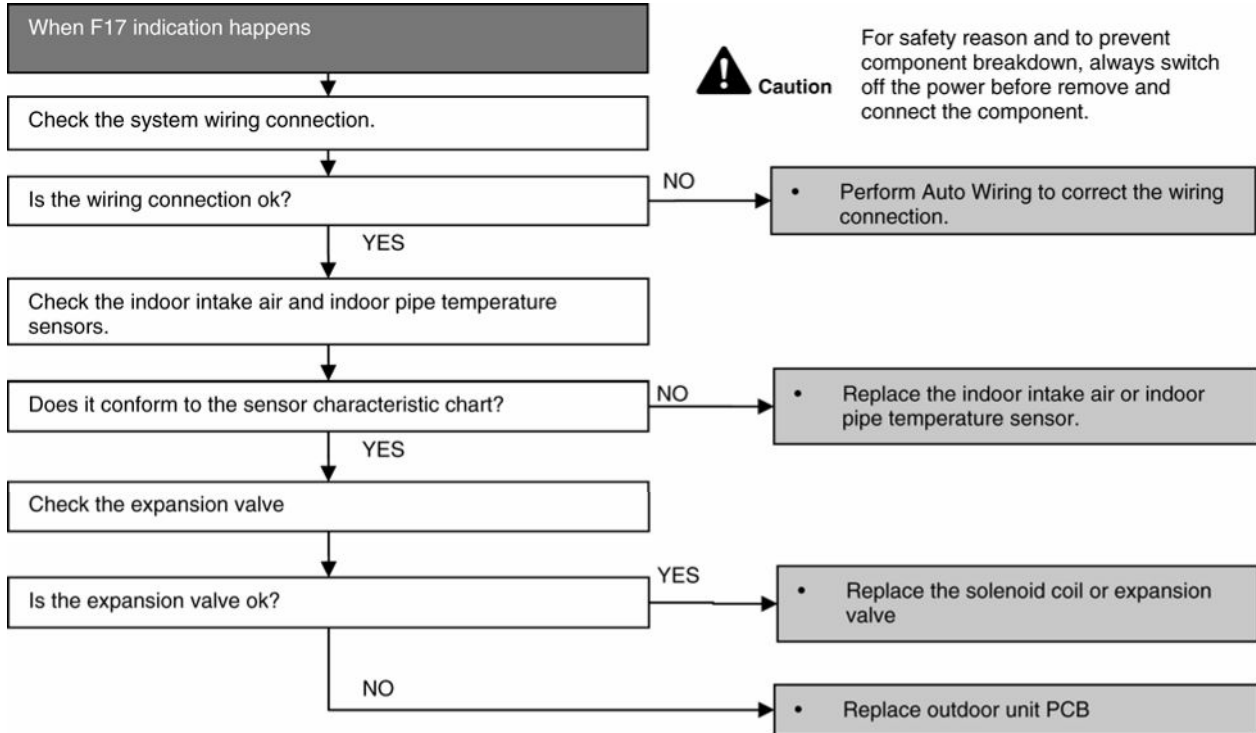

16.4.20 F90 (Power Factor Correction Protection)

Malfunction Decision Conditions

- During startup and operation of cooling and heating, when Power Factor Correction (PFC) protection circuitry at the outdoor unit main PCB senses abnormal high DC voltage level.

Malfunction Caused

- DC voltage peak due to power supply surge.
- DC voltage peak due to compressor windings not uniform.
- Faulty outdoor PCB.

Troubleshooting

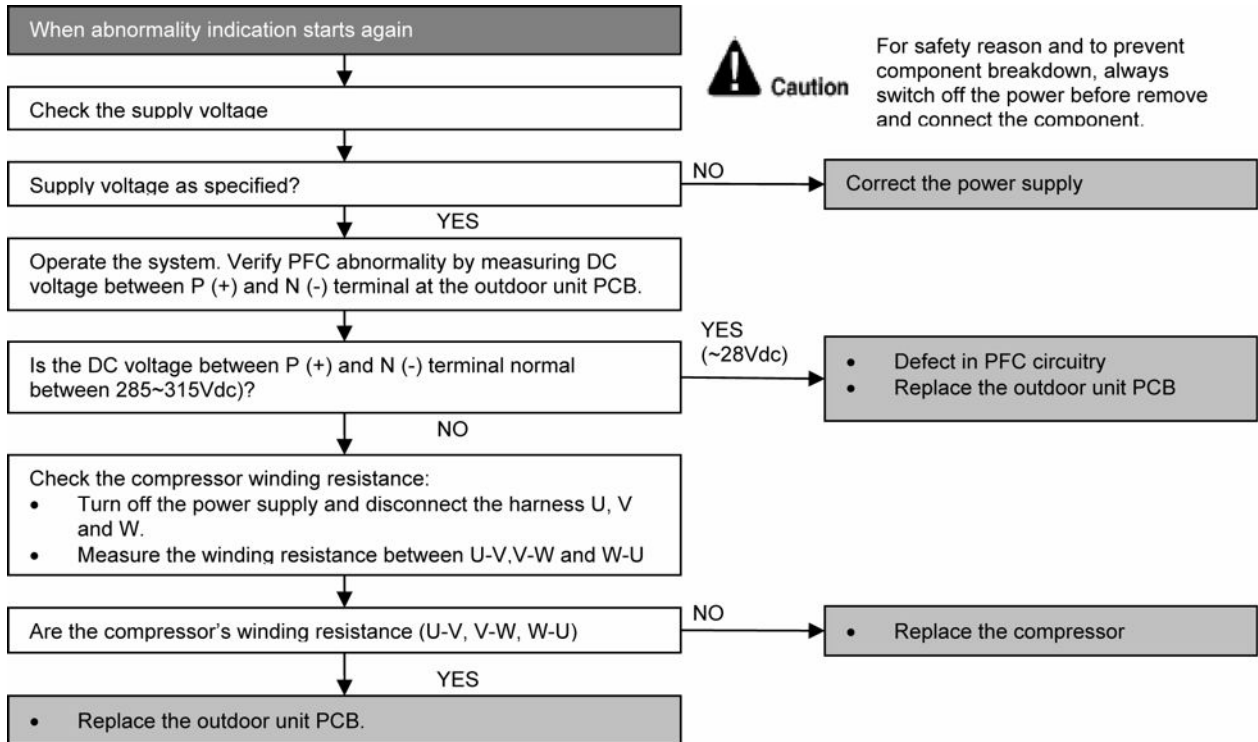

16.4.21 F91 (Refrigeration Cycle Abnormality)

Malfunction Decision Conditions

- During cooling, compressor frequency = F_{cmax} .
- During cooling and heating operation, running current: $0.65A < I < 1.65A$.
- During cooling, indoor intake - indoor pipe $< 39.2^{\circ}F$.

Malfunction Caused

- Refrigerant shortage (refrigerant leakage)
- Poor compression performance of compressor.
- 2/3 way valve closed.
- Detection error due to faulty indoor intake air or indoor pipe temperature sensors.

Troubleshooting

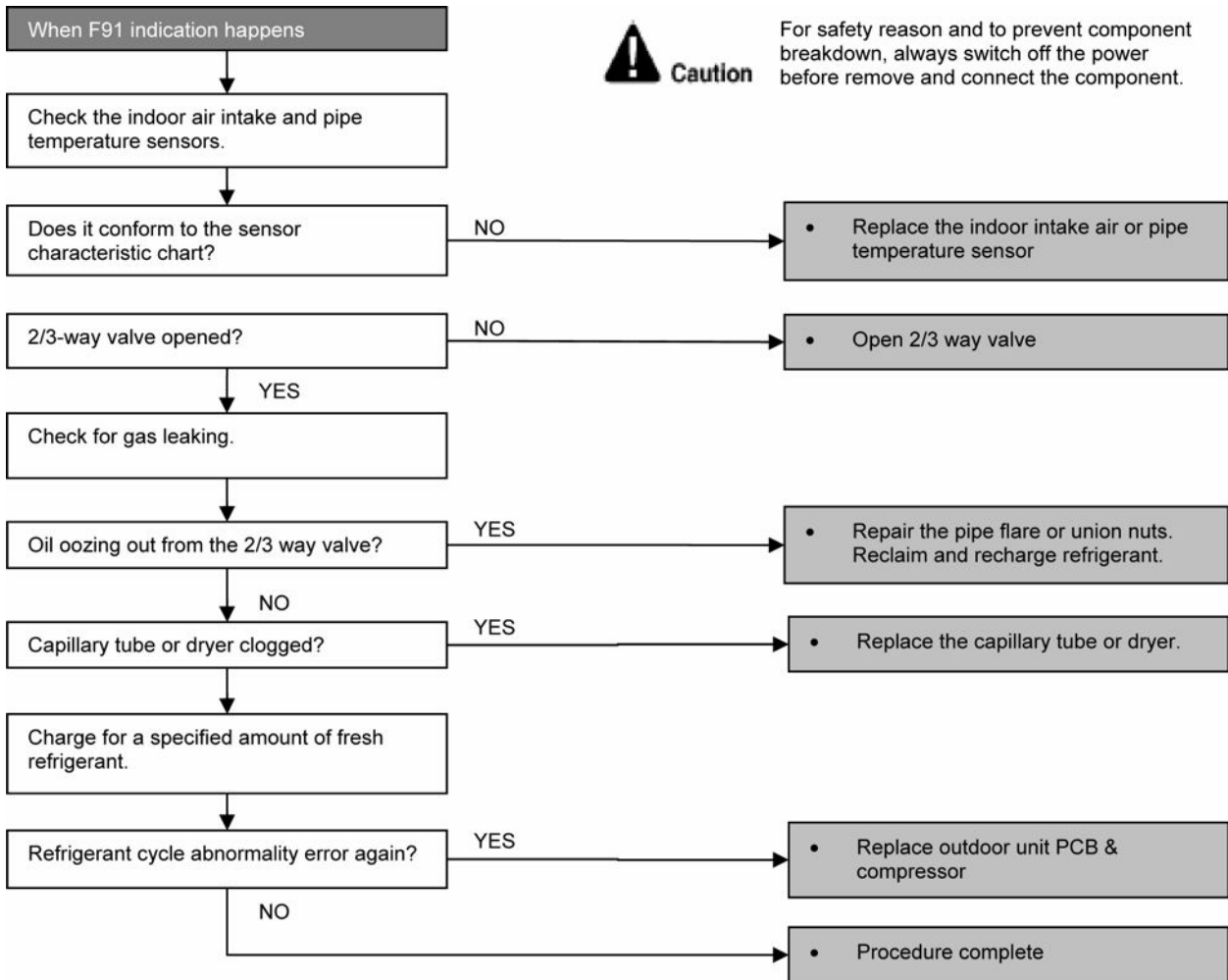

16.4.22 F93 (Compressor Rotation Failure)

Malfunction Decision Conditions

A compressor rotation failure is detected by checking the compressor running condition through the position detection circuit.

Malfunction Caused

- Compressor terminal disconnect
- Outdoor PCB malfunction

Troubleshooting

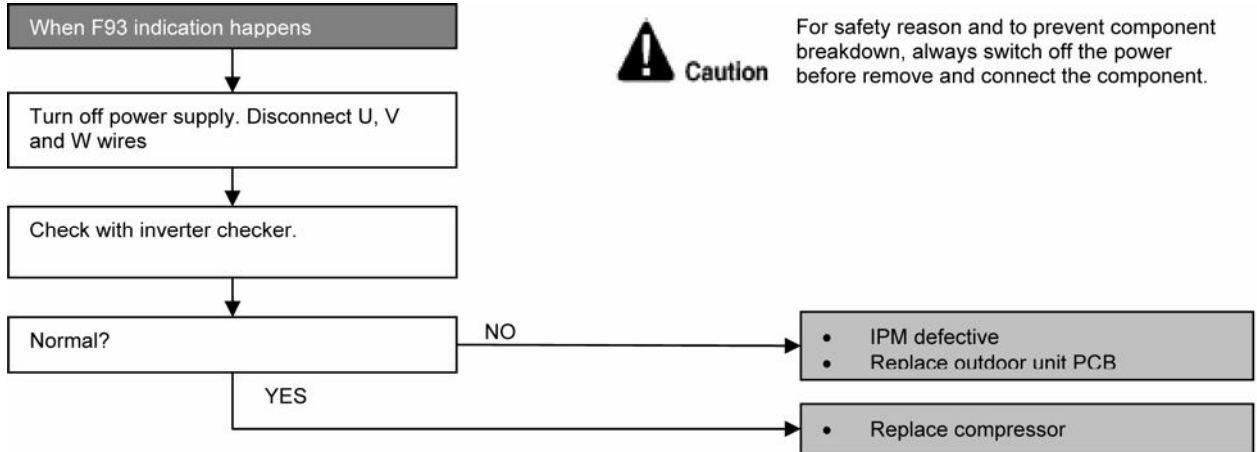

16.4.23 F95 (Cooling High Pressure Abnormality)

Malfunction Decision Conditions

During operation of cooling, when outdoor unit heat exchanger high temperature data (141.8°F) is detected by the outdoor pipe temperature sensor.

Malfunction Caused

- Outdoor pipe temperature rise due to short circuit of hot discharge air flow.
- Outdoor pipe temperature rise due to defective of outdoor fan motor.
- Outdoor pipe temperature rise due to defective outdoor pipe temperature sensor.
- Outdoor pipe temperature rise due to defective outdoor unit PCB.

Troubleshooting

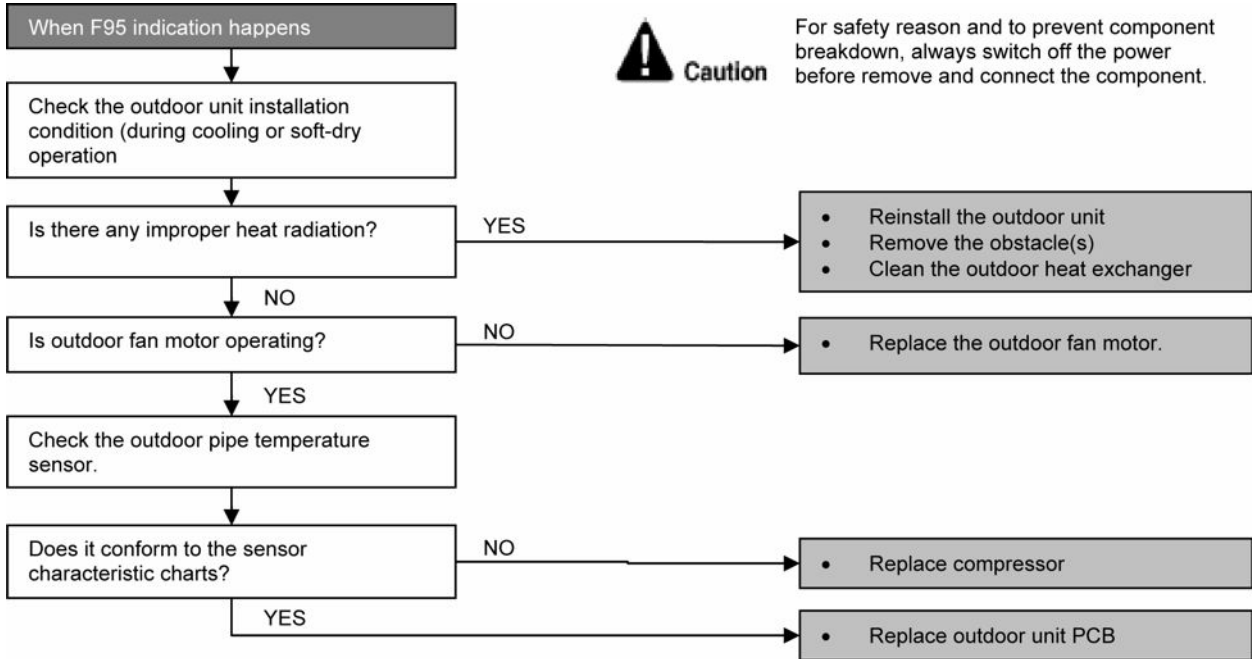

16.4.24 F96 (IPM Overheating)

Malfunction Decision Conditions

During operating of cooling and heating, when IPM temperature data (212°F) is detected by the IPM temperature sensor.

Malfunction Caused

- IPM overheats due to short circuit of hot discharge air flow.
- IPM overheats due to defective of outdoor fan motor.
- IPM overheats due to defective of internal circuitry of IPM.
- IPM overheats due to defective IPM temperature sensor.

Troubleshooting

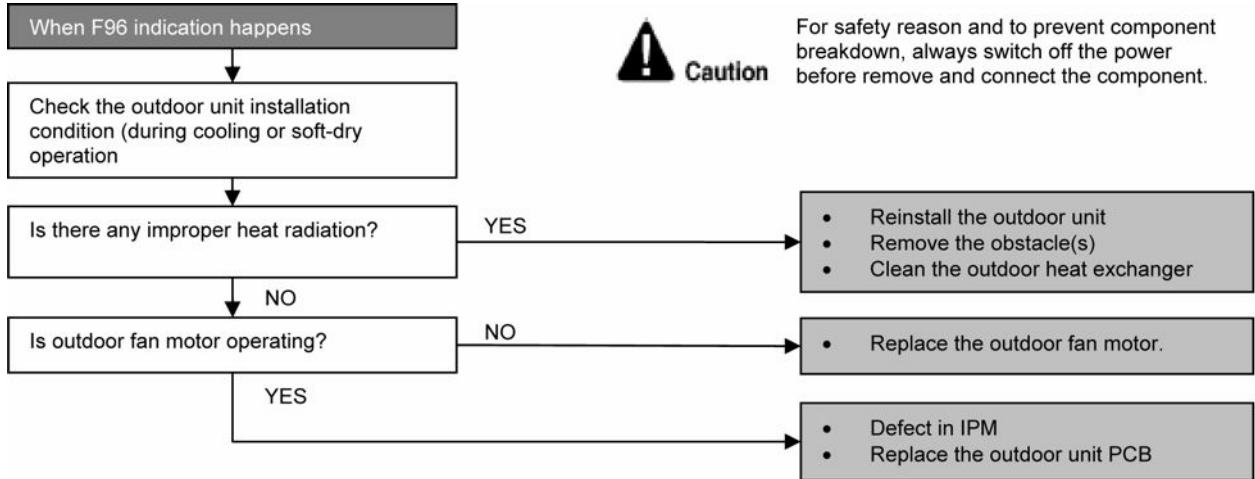

16.4.25 F97 (Compressor Overheating)

Malfunction Decision Conditions

During operation of cooling and heating, when compressor tank temperature data (233.6°F) is detected by the compressor tank temperature sensor.

Malfunction Caused

- Refrigerant shortage (refrigerant leakage).
- 2/3 way valve closed.
- Detection error due to faulty compressor tank temperature sensor.

Troubleshooting

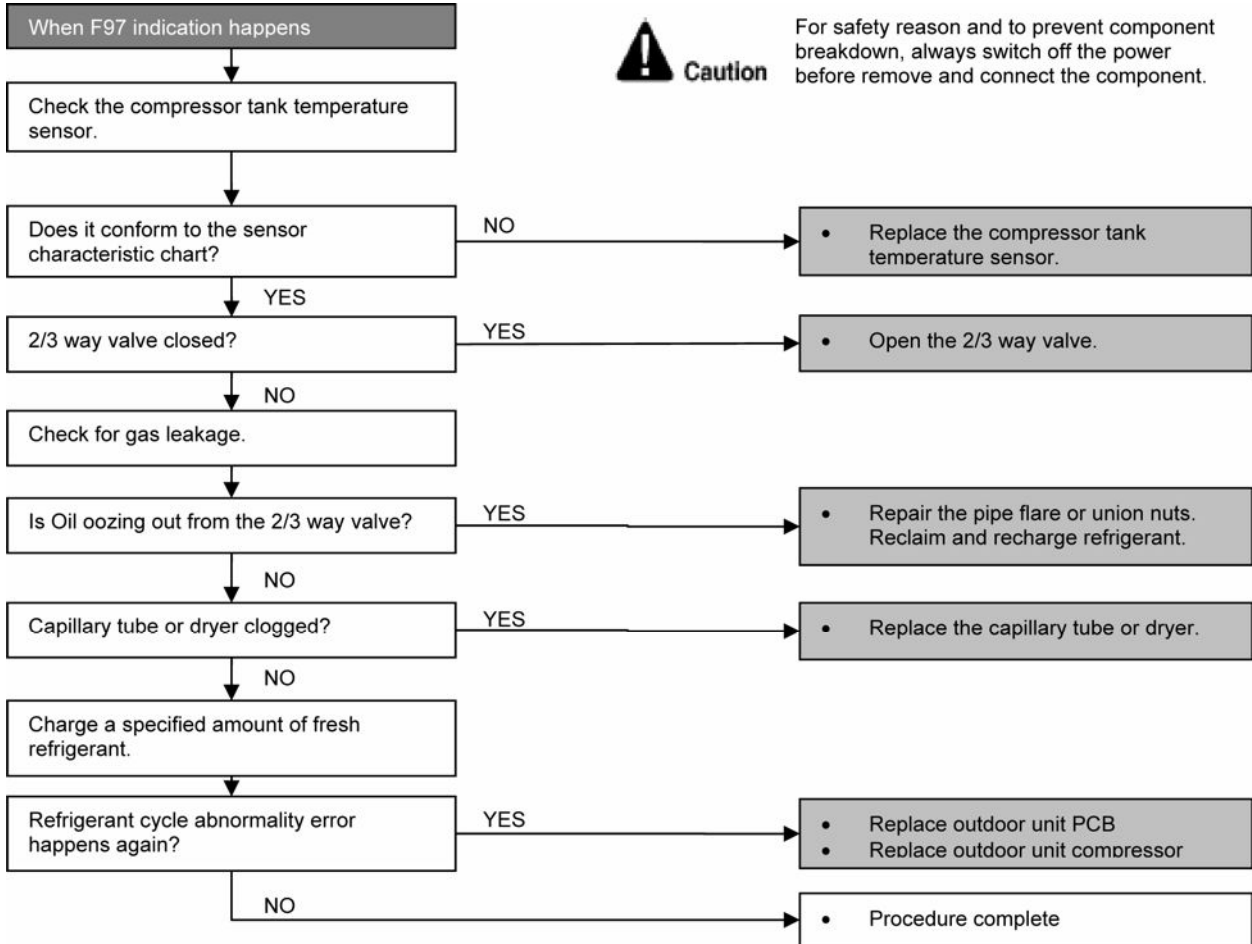

16.4.26 F98 (Input Over Current Detection)

Malfunction Decision Conditions

During cooling and heating operation, when an input over-current (16.8A) is detected by checking the input current value being detected by current transformer (CT) with the compressor running.

Malfunction Caused

- Over-current due to compressor failure.
- Over-current due to defective outdoor unit PCB.
- Over-current due to defective inverter main circuit electrolytic capacitor.
- Over-current due to excessive refrigerant.

Troubleshooting

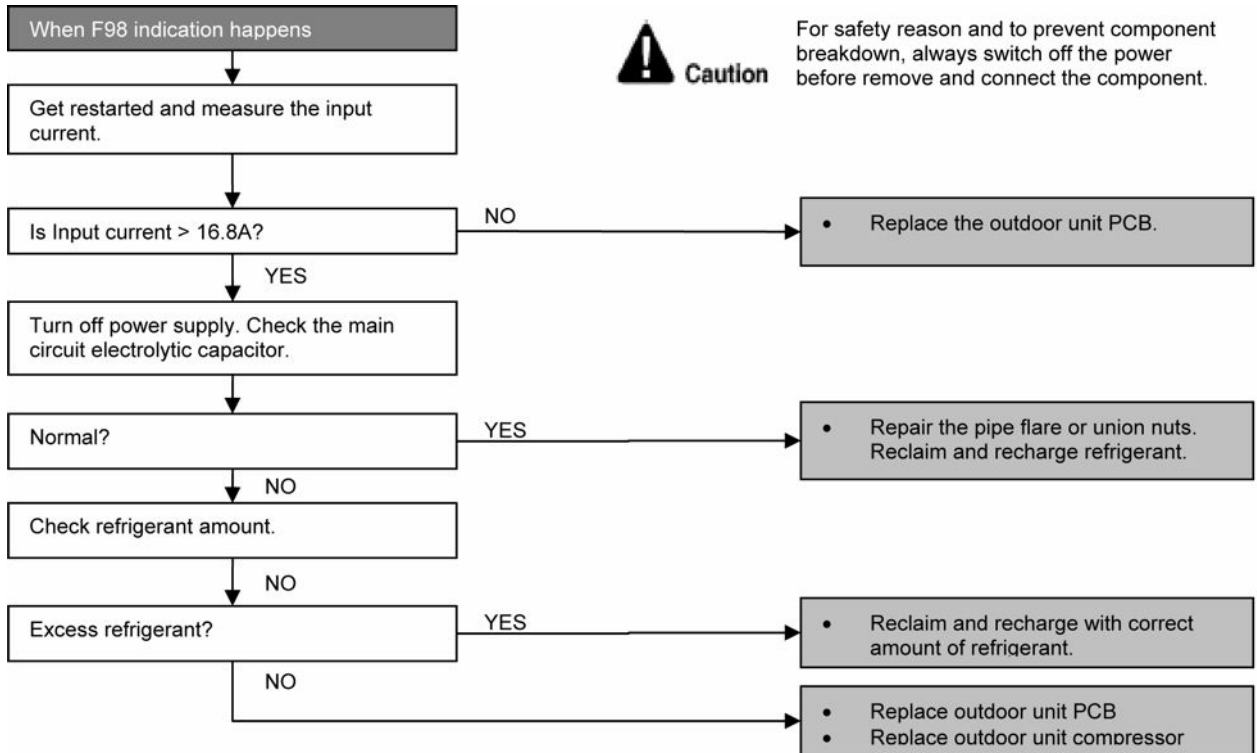

16.4.27 F99 (Output Over Current Detection)

Malfunction Decision Conditions

During operation of cooling and heating, when an output over-current (18.5A) is detected by checking the current that flows in the inverter DC peak sensing circuitry.

Malfunction Caused

- DC peak due to compressor failure.
- DC peak due to defective power transistor(s).
- DC peak due to defective outdoor unit PCB.

Troubleshooting

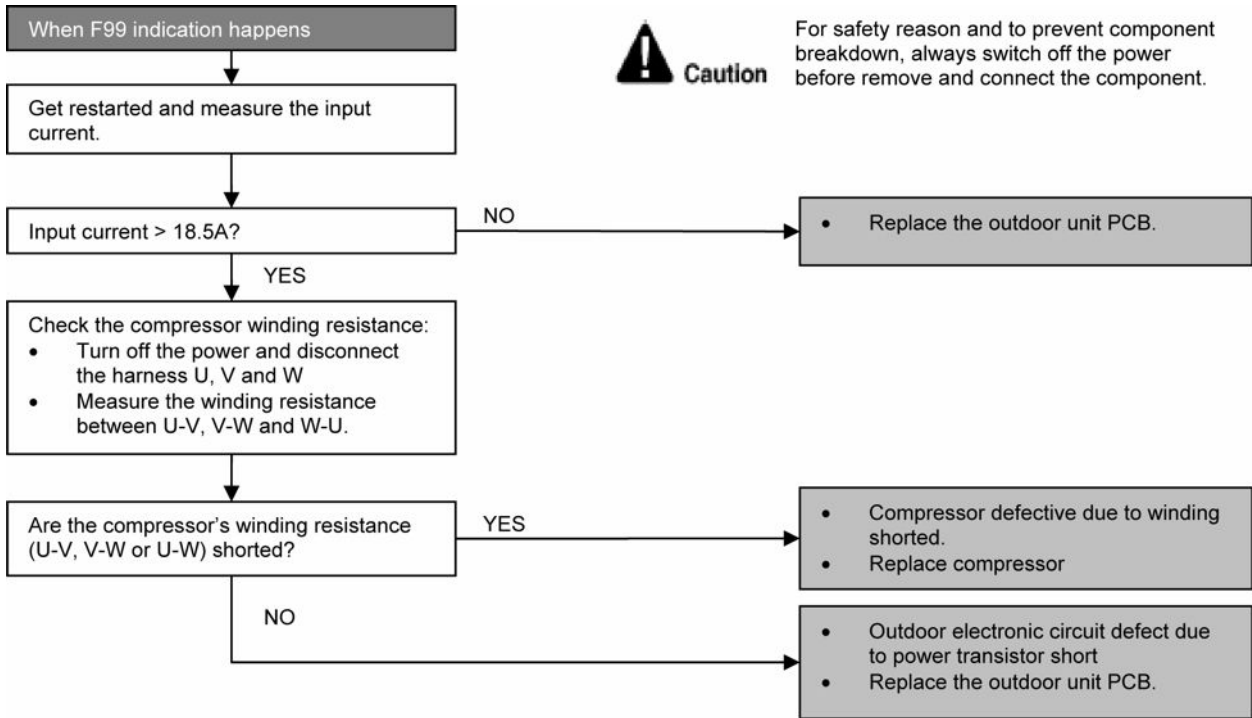

- Checking the power transistor
- Never touch any live parts for at least 10 minutes after turning off the circuit breaker.
- If unavoidable necessary to touch a live part, make sure the power transistor's supply voltage is below 50V using the tester.
- For the UVW, make measurement at the Faston terminal on the board of the relay connector.

Tester's negative terminal	Power transistor (+)	UVW	Power transistor (-)	UVW
Tester's positive terminal	UVW	Power transistor (+)	UVW	Power transistor (-)
Normal resistance	Several kΩ to several MΩ			
Abnormal resistance	0 or ∞			

17. Disassembly and Assembly Instructions



High Voltage is generated in the electrical parts area by the capacitor. Ensure that the capacitor has discharged sufficiently before proceeding with repair work. Failure to heed this caution may result in electric shocks.

17.1 Indoor Electronic Controllers, Cross Flow Fan and Indoor Fan Motor Removal Procedures

17.1.1 To remove front grille

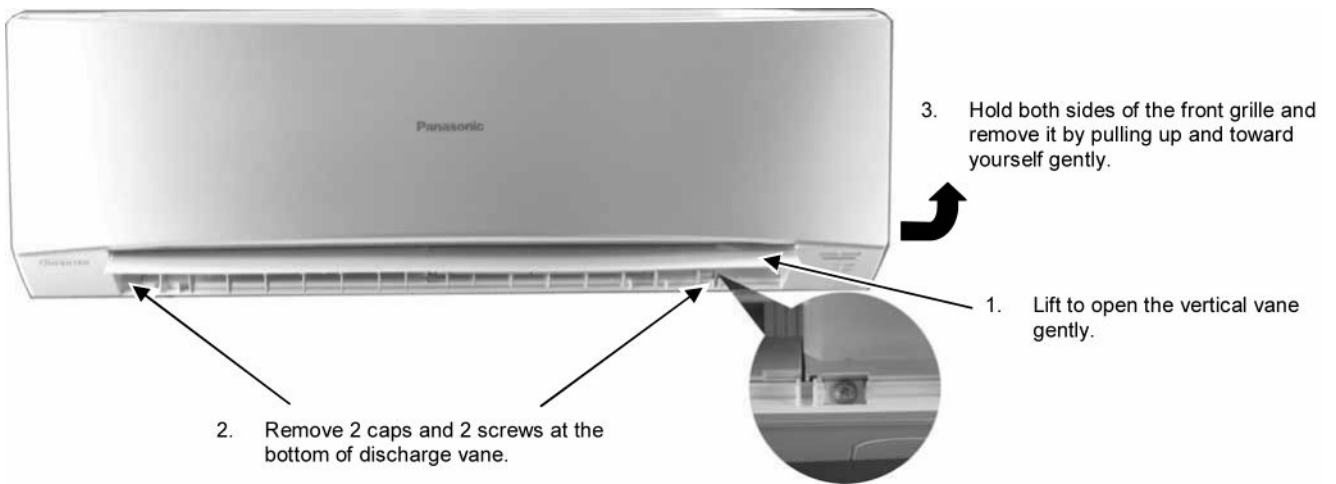

Figure 1

17.1.1.1 To remove power electronic controller

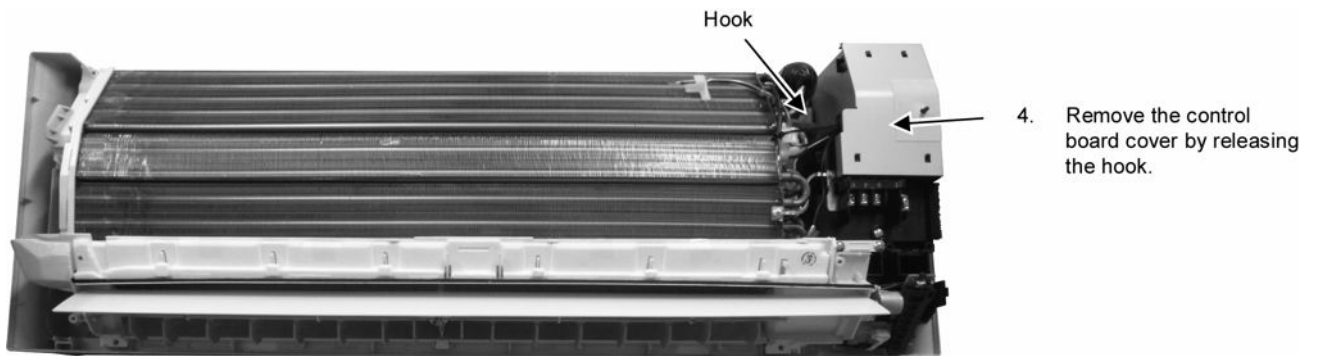

Figure 2

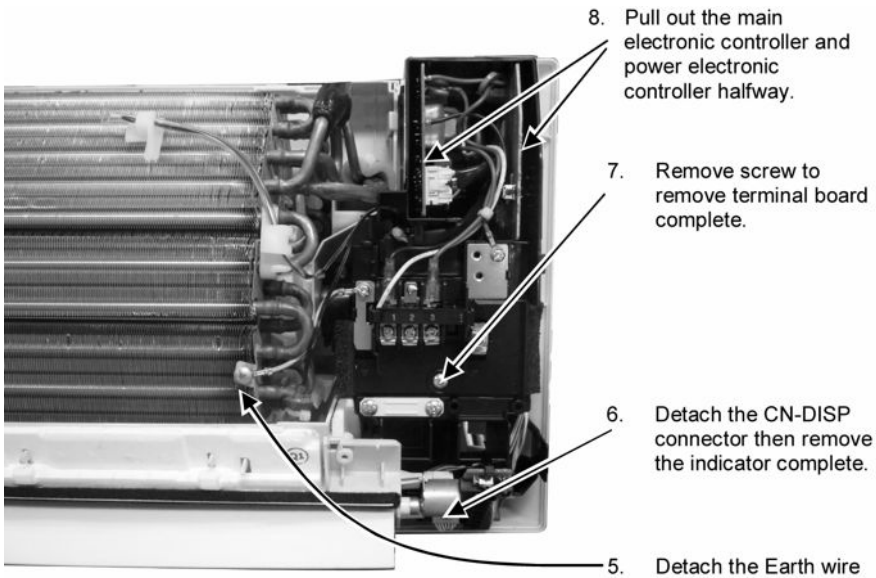

Figure 3

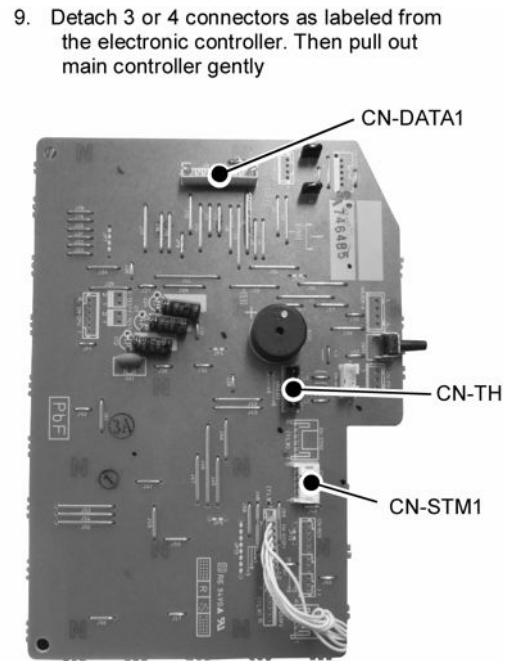

Figure 4

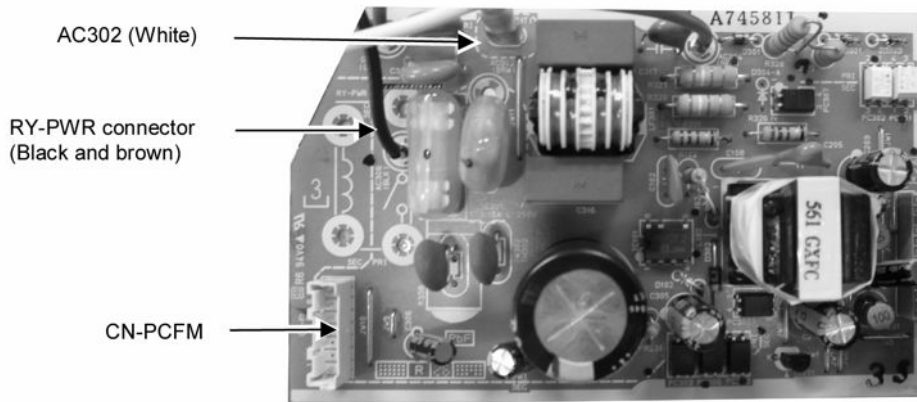

Figure 5

17.1.1.2 To remove discharge grille

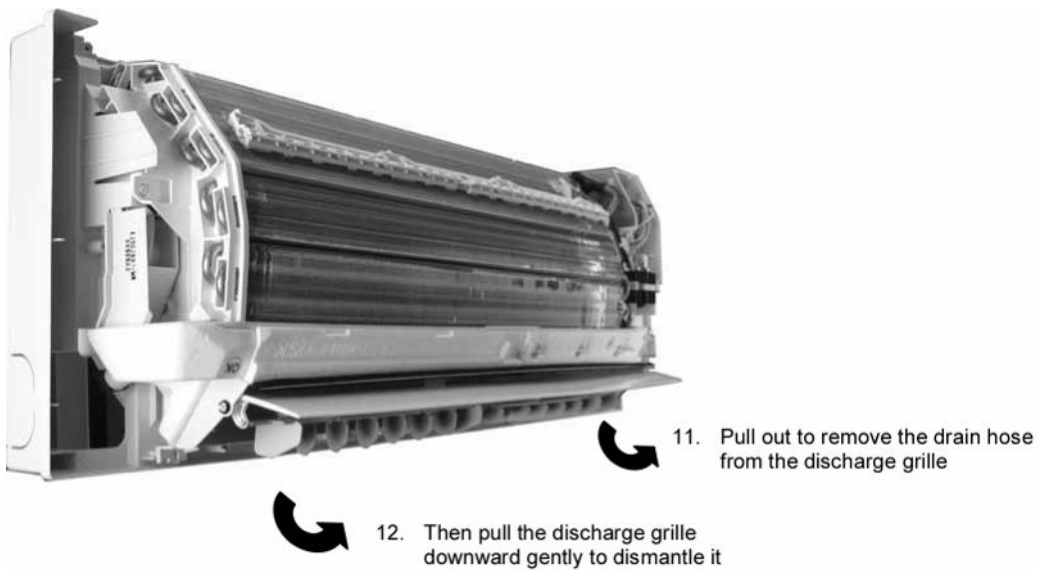

Figure 6

17.1.1.3 To remove control board

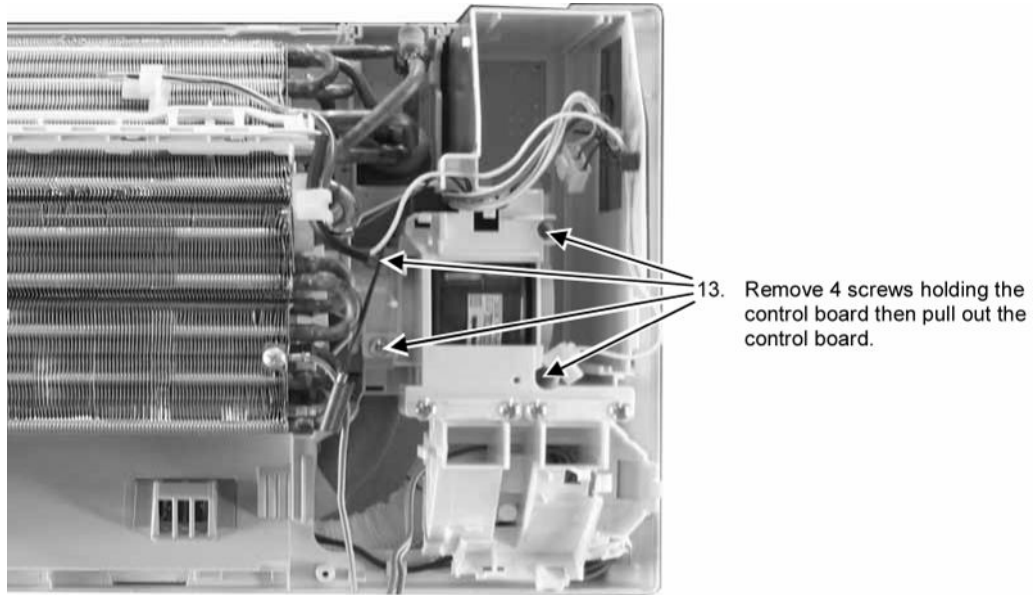

Figure 7

17.1.1.4 To remove cross flow fan and indoor fan motor

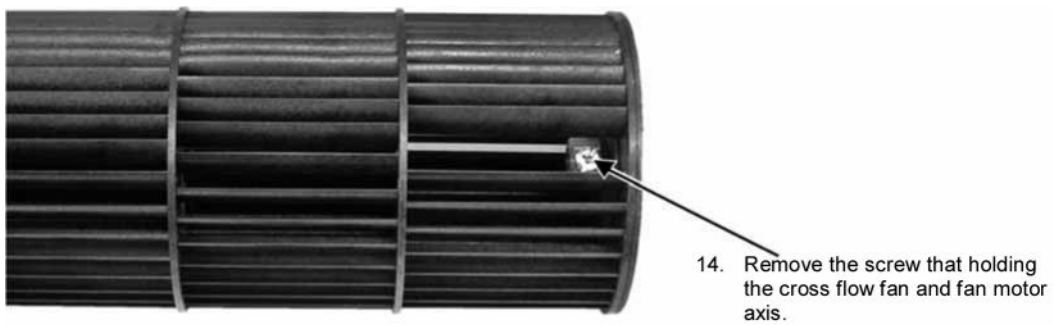

Figure 8

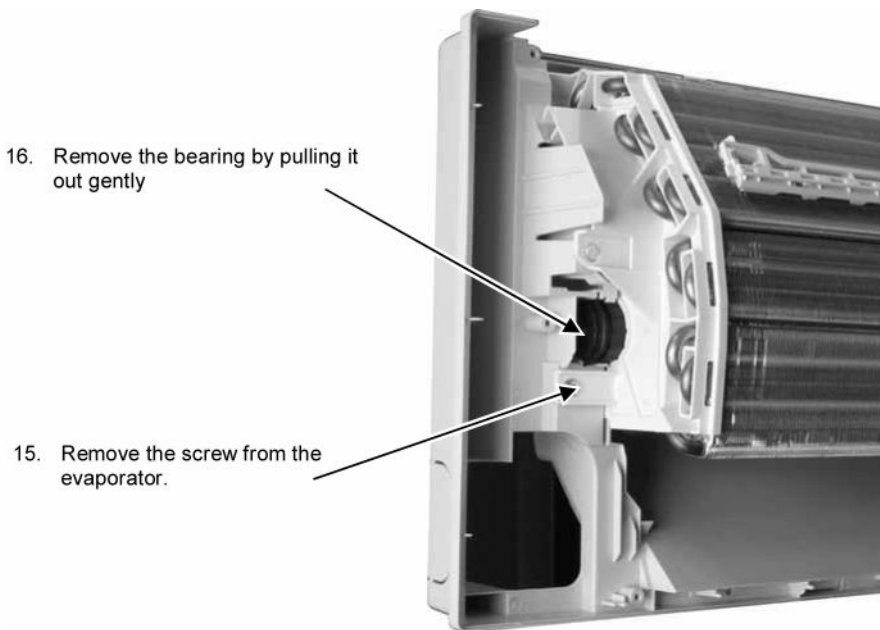

Figure 9

17. Push the holdfast to the left and lift up the evaporator.

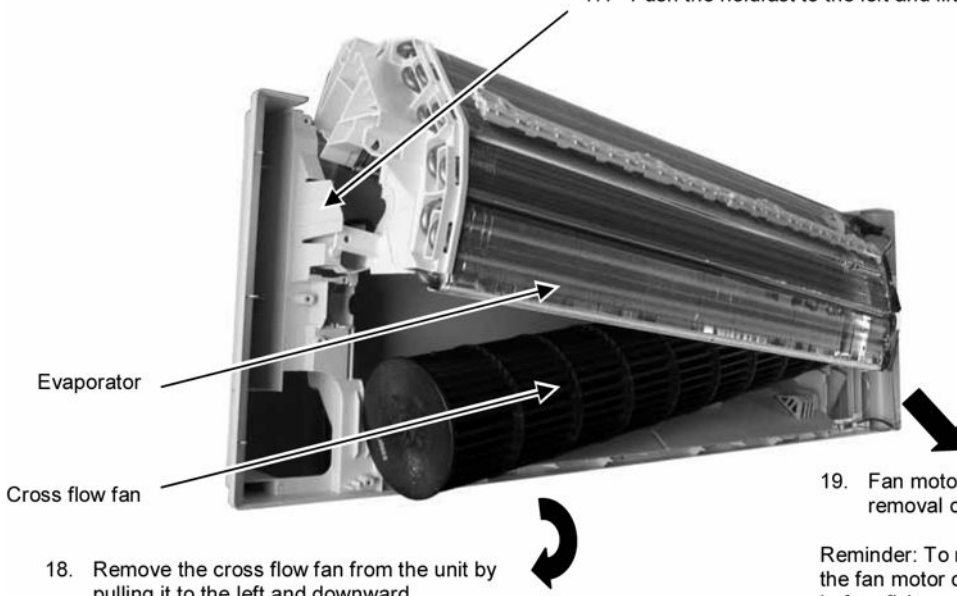

Figure 10

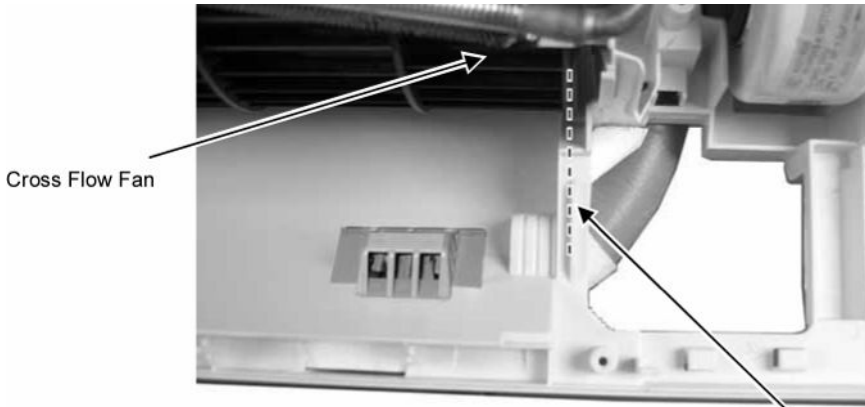

Figure 11

18. Technical Data

18.1 Operation Characteristics

18.1.1 CS-E9NK CU-E9NK

- Cooling Characteristic
 - Room temperature: 81°F (DBT), 66°F (WBT)
 - Operation condition: High fan speed
 - Piping length: 24.6ft
 - Compressor Frequency : Fc

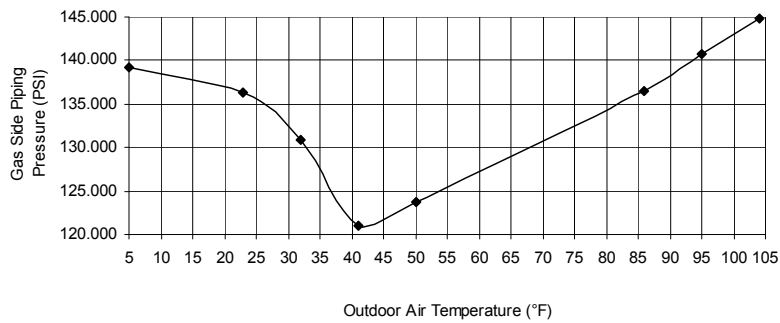
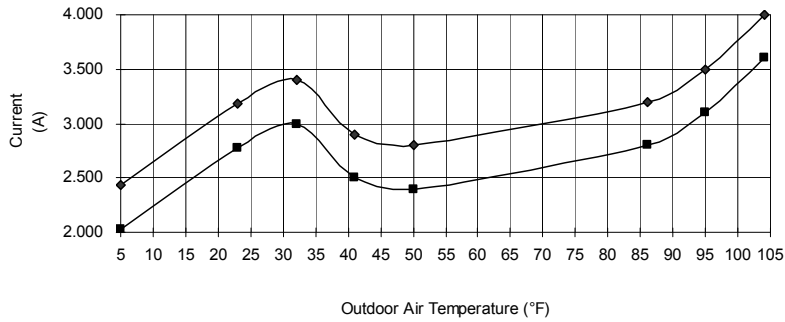
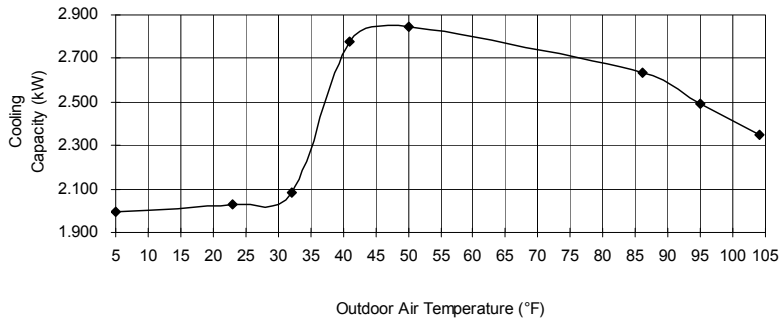
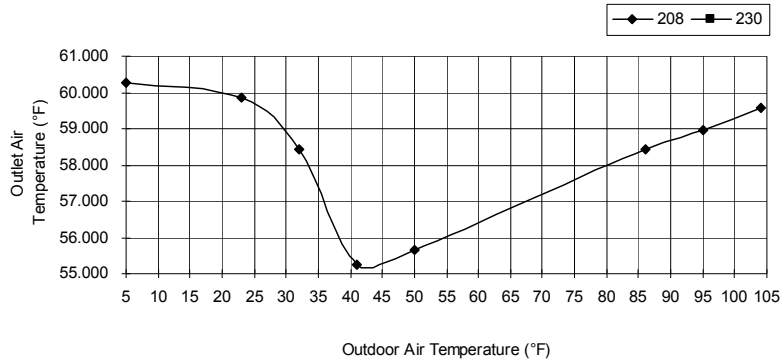

- Piping Length Characteristic Cooling
 - Room temperature: 81°F (DBT), 66°F (WBT)
 - Operation condition: High fan speed
 - Outdoor temperature: 95°F (DBT)
 - Compressor Frequency : Fc

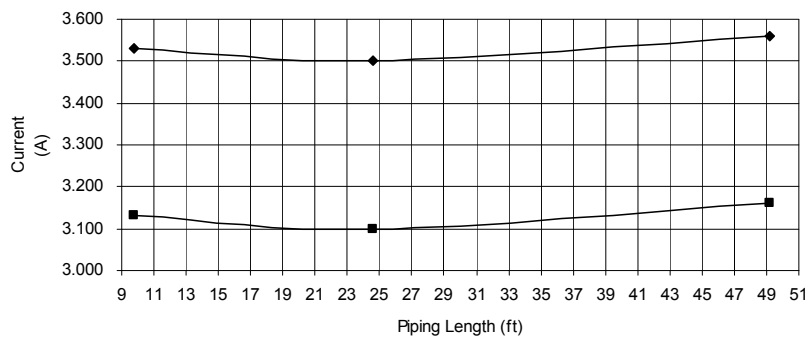
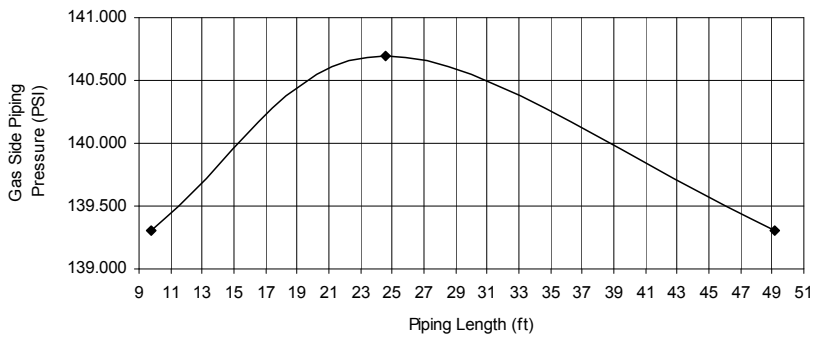
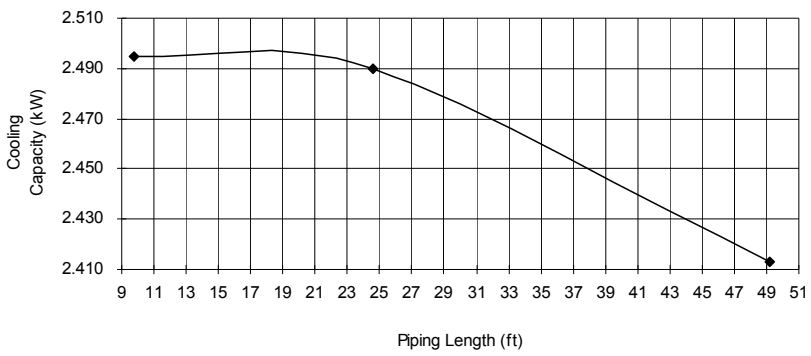
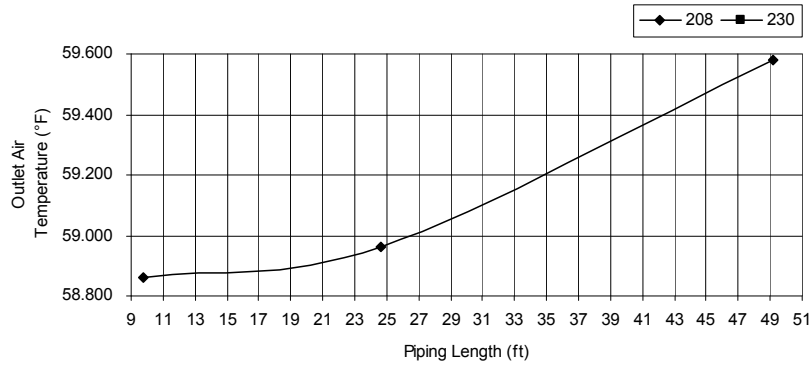

- Heating Characteristic
 - Room temperature: 68°F (DBT)
 - Operation condition: High fan speed
 - Piping length: 24.6ft
 - Compressor Frequency : Fh

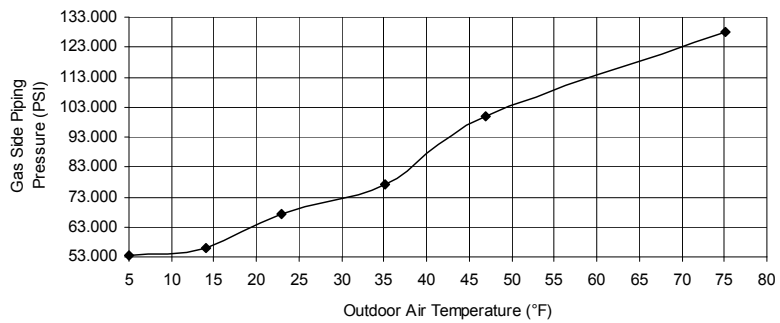
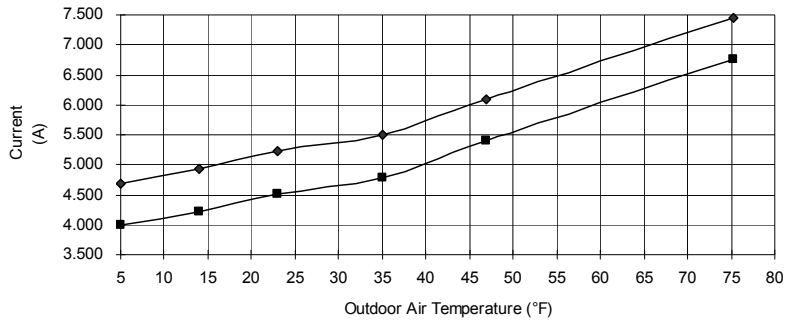
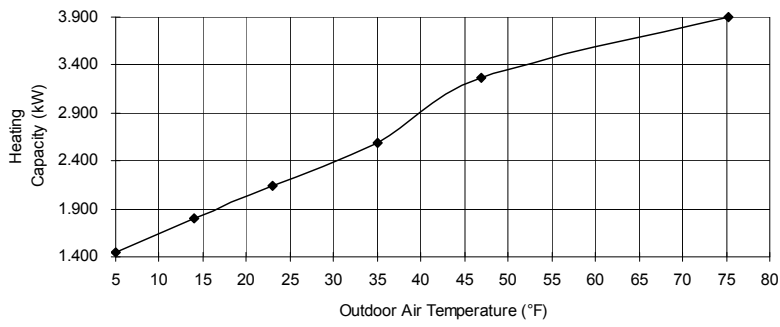
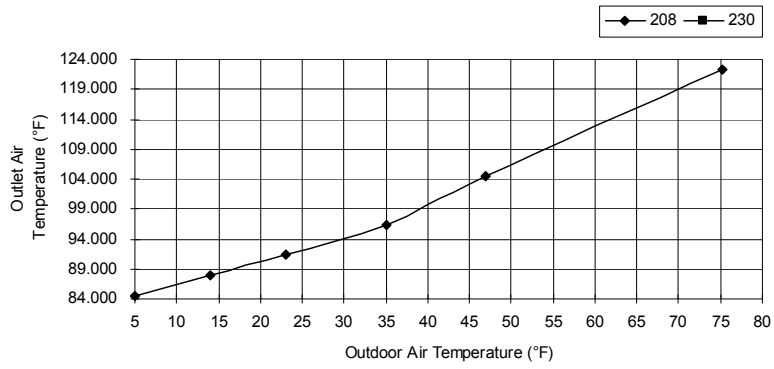

- Piping Length Characteristic Heating
 - Room temperature: 68°F (DBT)
 - Operation condition: High fan speed
 - Outdoor temperature: 47°F (DBT), 43°F (WBT)
 - Compressor Frequency : Fh

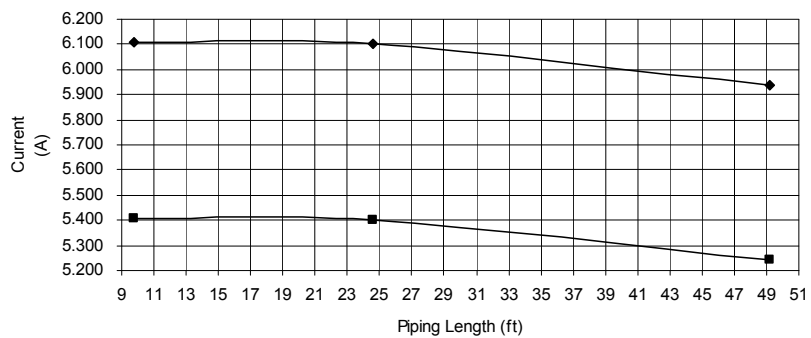
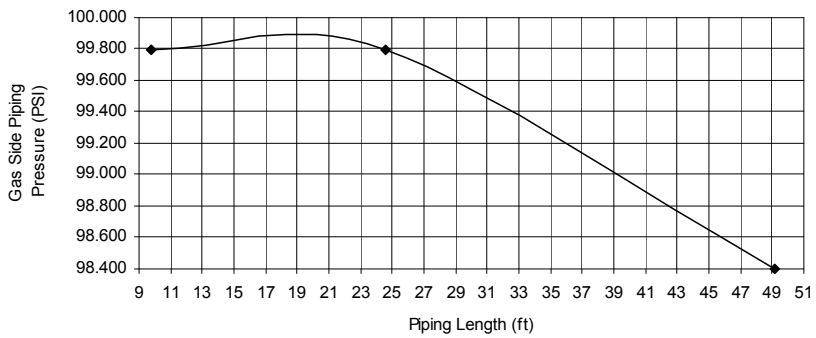
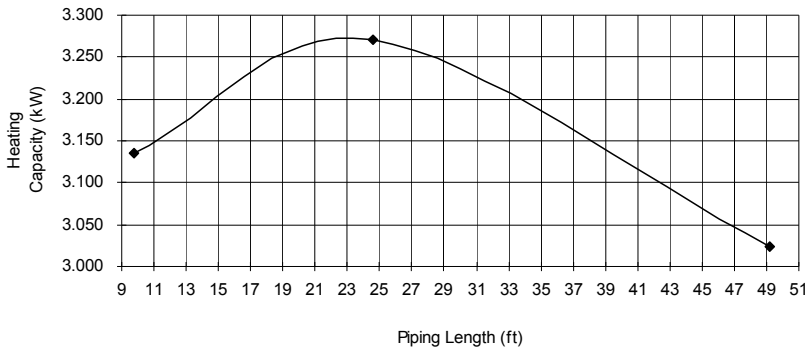
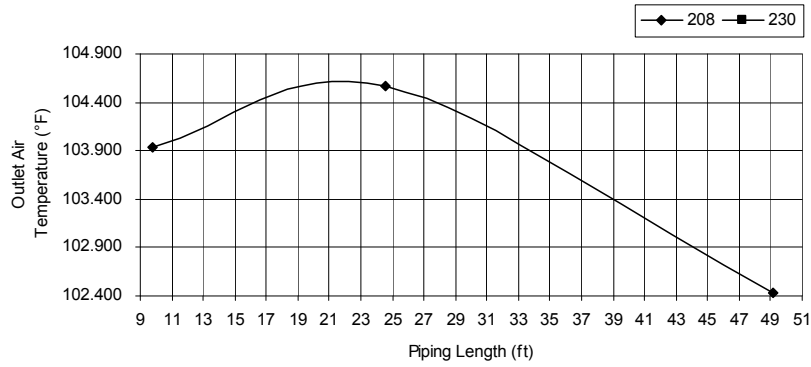

18.1.2 CS-E12NK CU-E12NK

- Cooling Characteristic
 - Room temperature: 81°F (DBT), 66°F (WBT)
 - Operation condition: High fan speed
 - Piping length: 24.6ft
 - Compressor Frequency : Fc

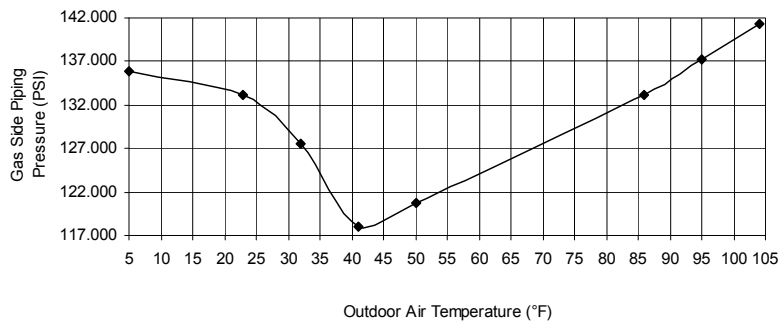
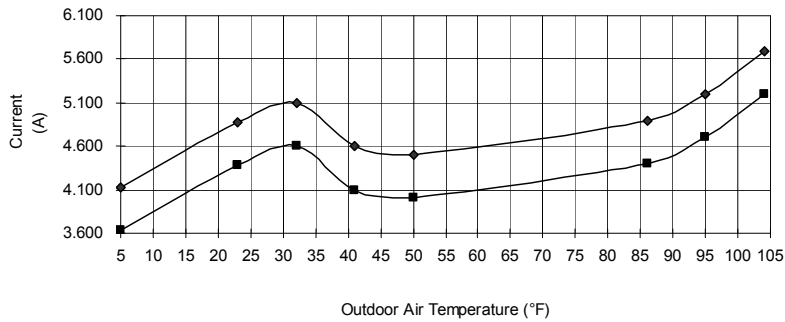
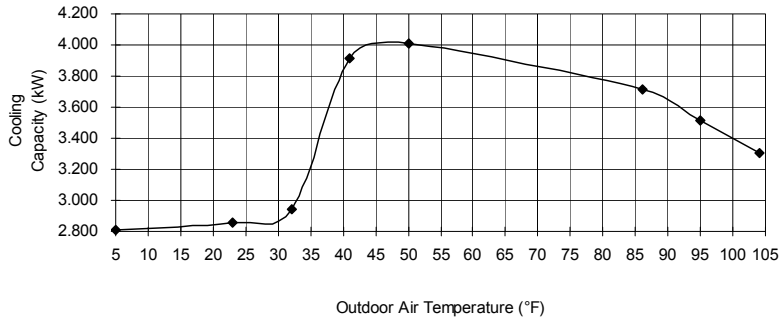
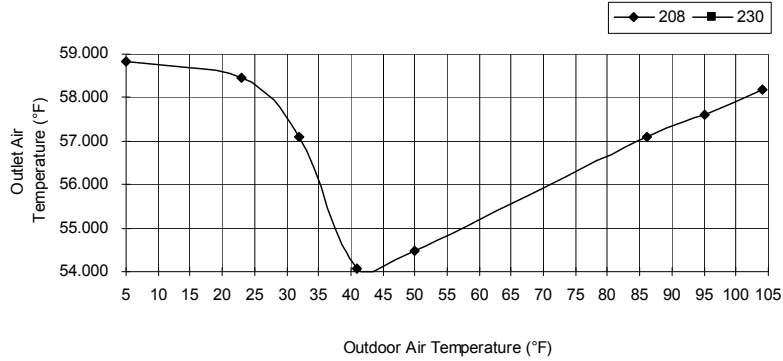

- Piping Length Characteristic Cooling
 - Room temperature: 81°F (DBT), 66°F (WBT)
 - Operation condition: High fan speed
 - Outdoor temperature: 95°F (DBT)
 - Compressor Frequency : Fc

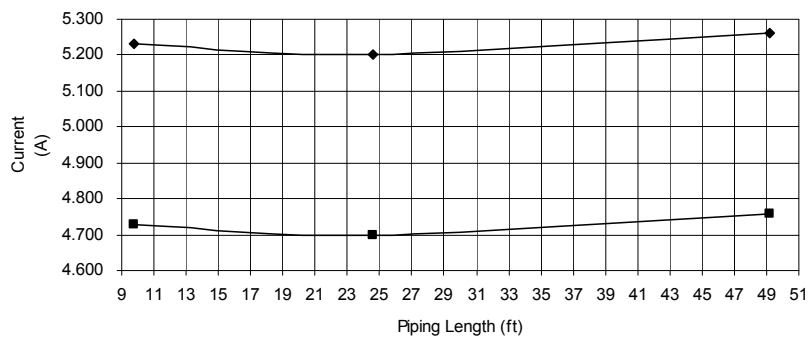
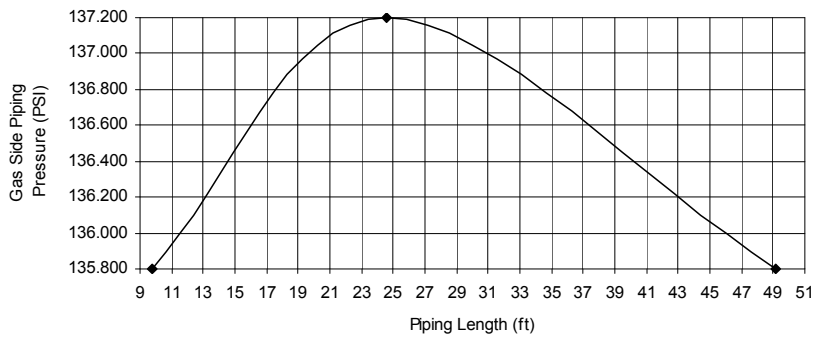
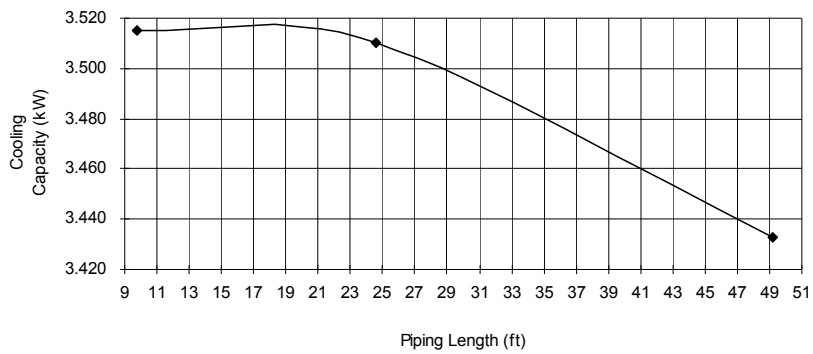
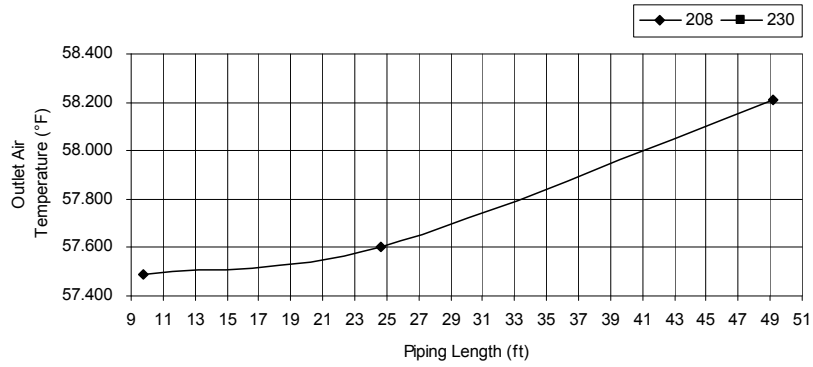

- Heating Characteristic
 - Room temperature: 68°F (DBT)
 - Operation condition: High fan speed
 - Piping length: 24.6ft
 - Compressor Frequency : Fh

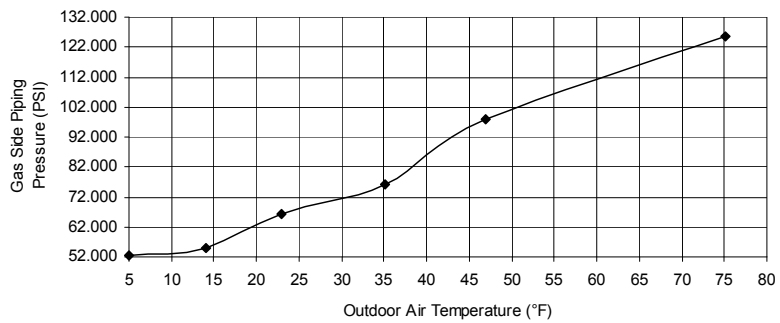
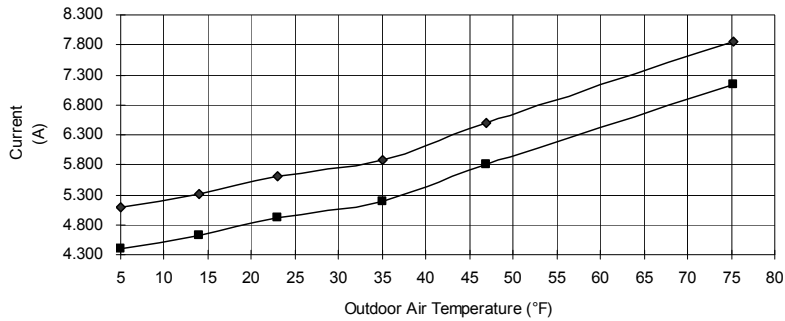
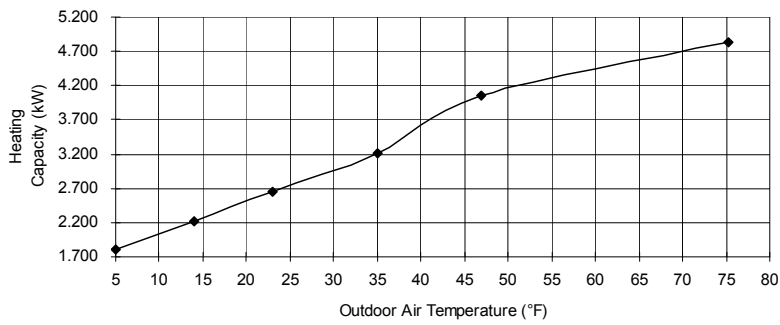
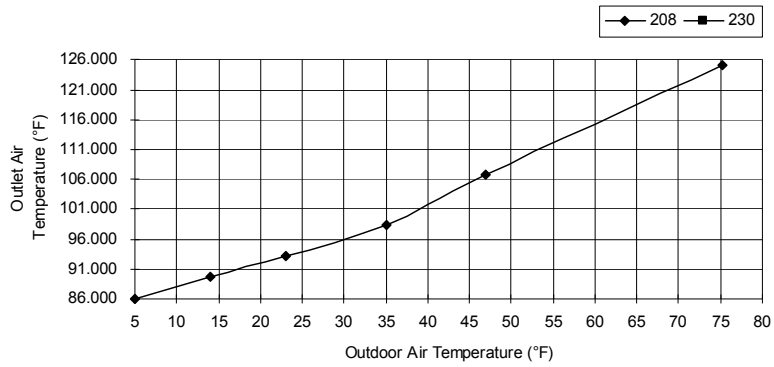

- Piping Length Characteristic Heating
 - Room temperature: 68°F (DBT)
 - Operation condition: High fan speed
 - Outdoor temperature: 47°F (DBT), 43°F (WBT)
 - Compressor Frequency : Fh

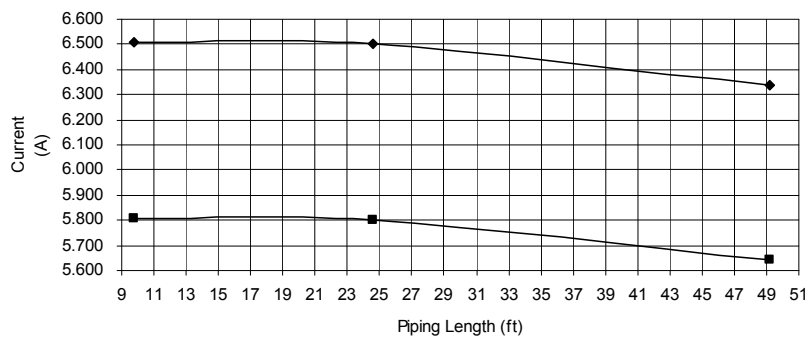
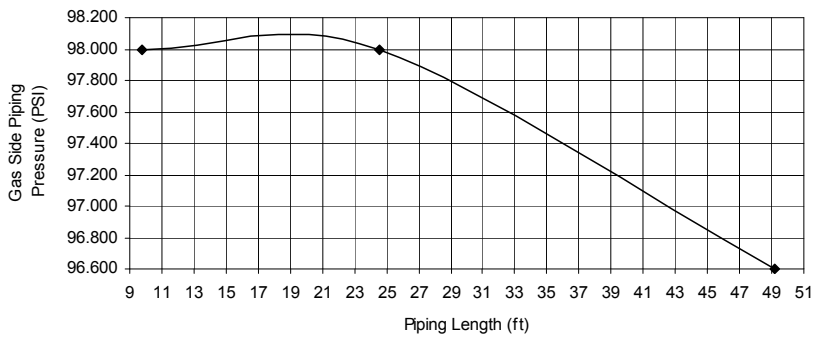
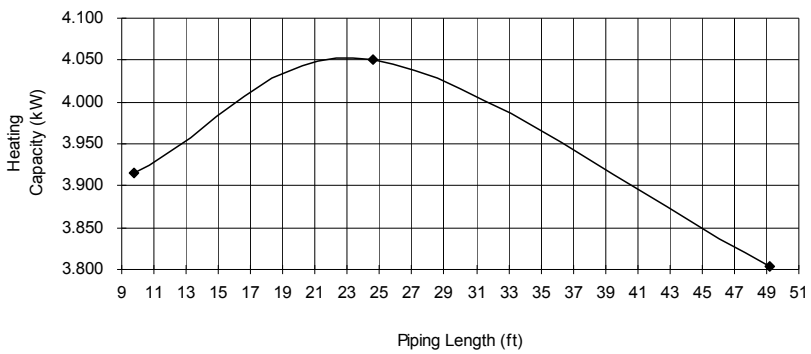
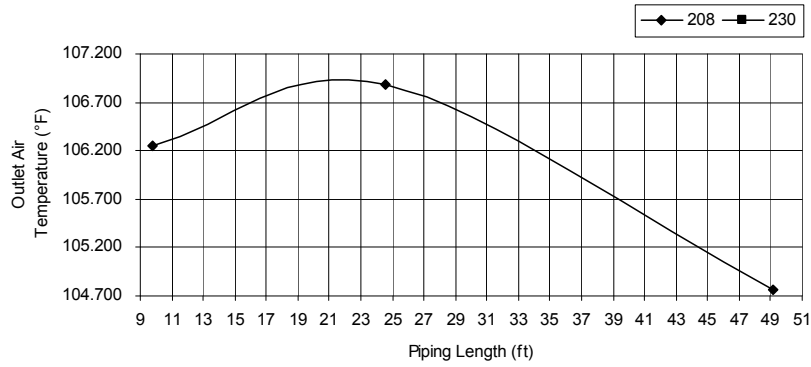

19. Exploded View and Replacement Parts List

19.1 Indoor Unit

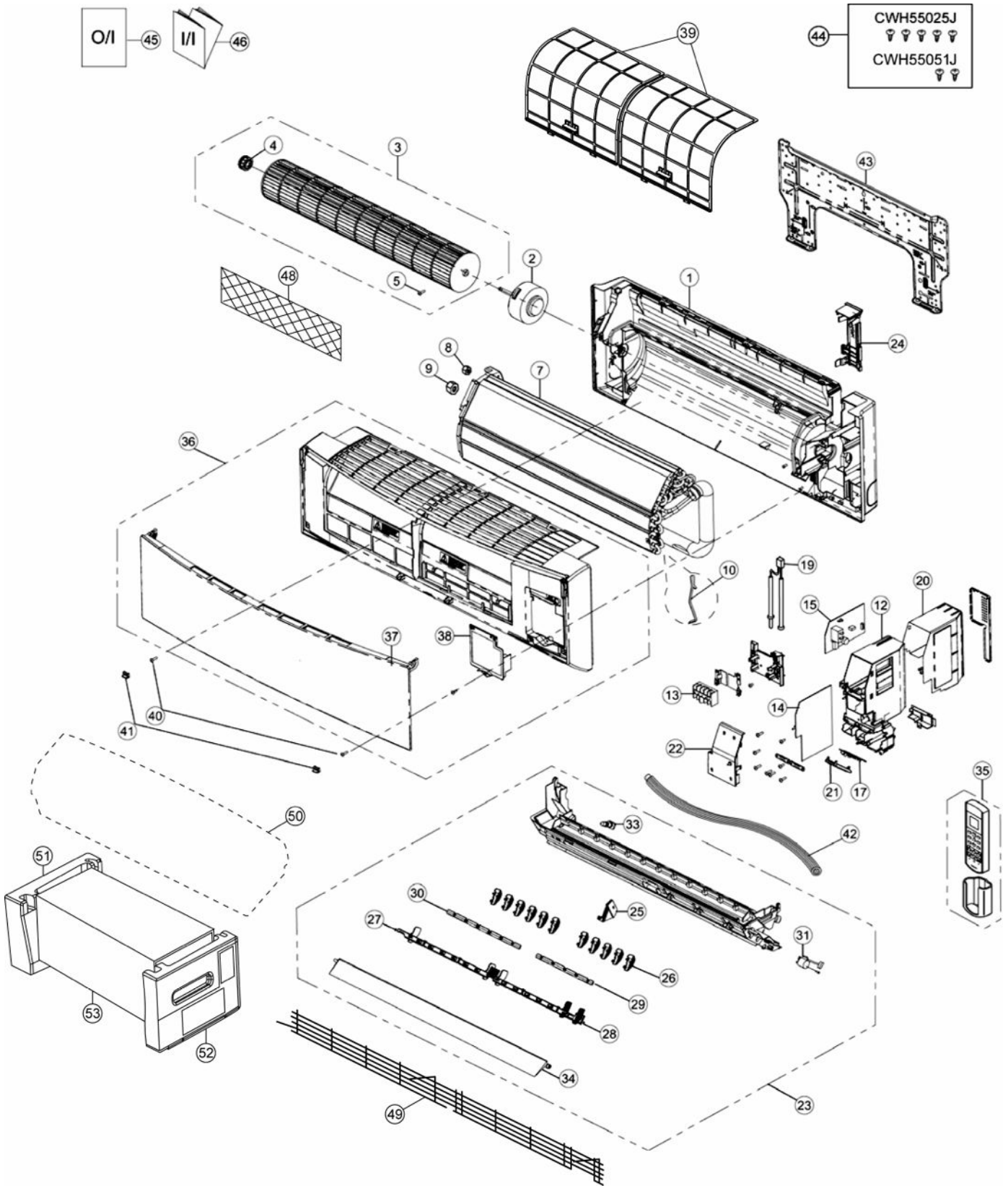

Note
 The above exploded view is for the purpose of parts disassembly and replacement.
 The non-numbered parts are not kept as standard service parts.

REF. NO.	PART NAME & DESCRIPTION	QTY.	CS-E9NKUAW	CS-E12NKUAW	REMARK
1	CHASSIS COMPLETE	1	CWD50C1633	←	
2	FAN MOTOR	1	L6CBYYYYL0055	←	O
3	CROSS-FLOW FAN COMPLETE	1	CWH02C1076	←	
4	BEARING ASSY	1	CWH64K007	←	
5	SCREW - CROSS-FLOW FAN	1	CWH551146	←	
7	EVAPORATOR	1	CWB30C3504	CWB30C3505	
8	FLARE NUT (LIQUID)	1	CWT251030	←	
9	FLARE NUT (GAS)	1	CWT251031	CWT251032	
10	CLIP FOR SENSOR	1	CWH32143	←	
12	CONTROL BOARD CASING	1	CWH102370A	←	
13	TERMINAL BOARD COMPLETE	1	CWA28C2357	←	O
14	ELECTRONIC CONTROLLER - MAIN	1	CWA73C6147	CWA73C6148	O
15	ELECTRONIC CONTROLLER - POWER	1	CWA746567	←	O
17	ELECTRONIC CONTROLLER - INDICATOR	1	CWA746489	←	O
19	SENSOR COMPLETE	1	CWA50C2800	←	O
20	CONTROL BOARD TOP COVER	1	CWH131350	←	
21	INDICATOR HOLDER	1	CWD933021	←	
22	CONTROL BOARD FRONT COVER CO.	1	CWH13C1201	←	
23	DISCHARGE GRILLE COMPLETE	1	CWE20C3038	←	
24	BACK COVER CHASSIS	1	CWD933233B	←	
25	FULCRUM	1	CWH621102	←	
26	VERTICAL VANE	11	CWE241287	←	
27	CONNECTING BAR	1	CWE261152	←	
28	CONNECTING BAR	1	CWE261154	←	
29	CONNECTING BAR	1	CWE261155	←	
30	CONNECTING BAR	1	CWE261153	←	
31	AIR SWING MOTOR	1	CWA981240	←	O
33	CAP - DRAIN TRAY	1	CWH521096	←	
34	HORIZONTAL VANE COMPLETE	1	CWE24C1268	←	
35	REMOTE CONTROL COMPLETE	1	CWA75C3724	←	O
36	FRONT GRILLE COMPLETE	1	CWE11C4512	←	O
37	INTAKE GRILLE COMPLETE	1	CWE22C1507	←	O
38	GRILLE DOOR COMPLETE	1	CWE14C1029	←	
39	AIR FILTER	2	CWD001279	←	O
40	SCREW - FRONT GRILLE	2	XTT4+16CFJ	←	
41	CAP - FRONT GRILLE	2	CWH521194	←	
42	DRAIN HOSE	1	CWH851173	←	
43	INSTALLATION PLATE	1	CWH361097	←	
44	BAG COMPLETE - INSTALLATION SCREW	1	CWH82C1705	←	
45	OPERATING INSTRUCTION	1	CWF568316	←	
46	INSTALLATION INSTRUCTION	1	CWF615169	←	
48	AIR PURIFYING FILTER	1	CWD00C1141	←	
49	WIRE NET	1	CWD041144A	←	
50	BAG	1	CWG861426	←	
51	SHOCK ABSORBER (L)	1	CWG712940	←	
52	SHOCK ABSORBER (R)	1	CWG712941	←	
53	C.C.CASE	1	CWG565009	←	

(Note)

- All parts are supplied from PHAAM, Malaysia (Vendor Code: 00029488).
- "O" marked parts are recommended to be kept in stock.

19.2 Outdoor Unit

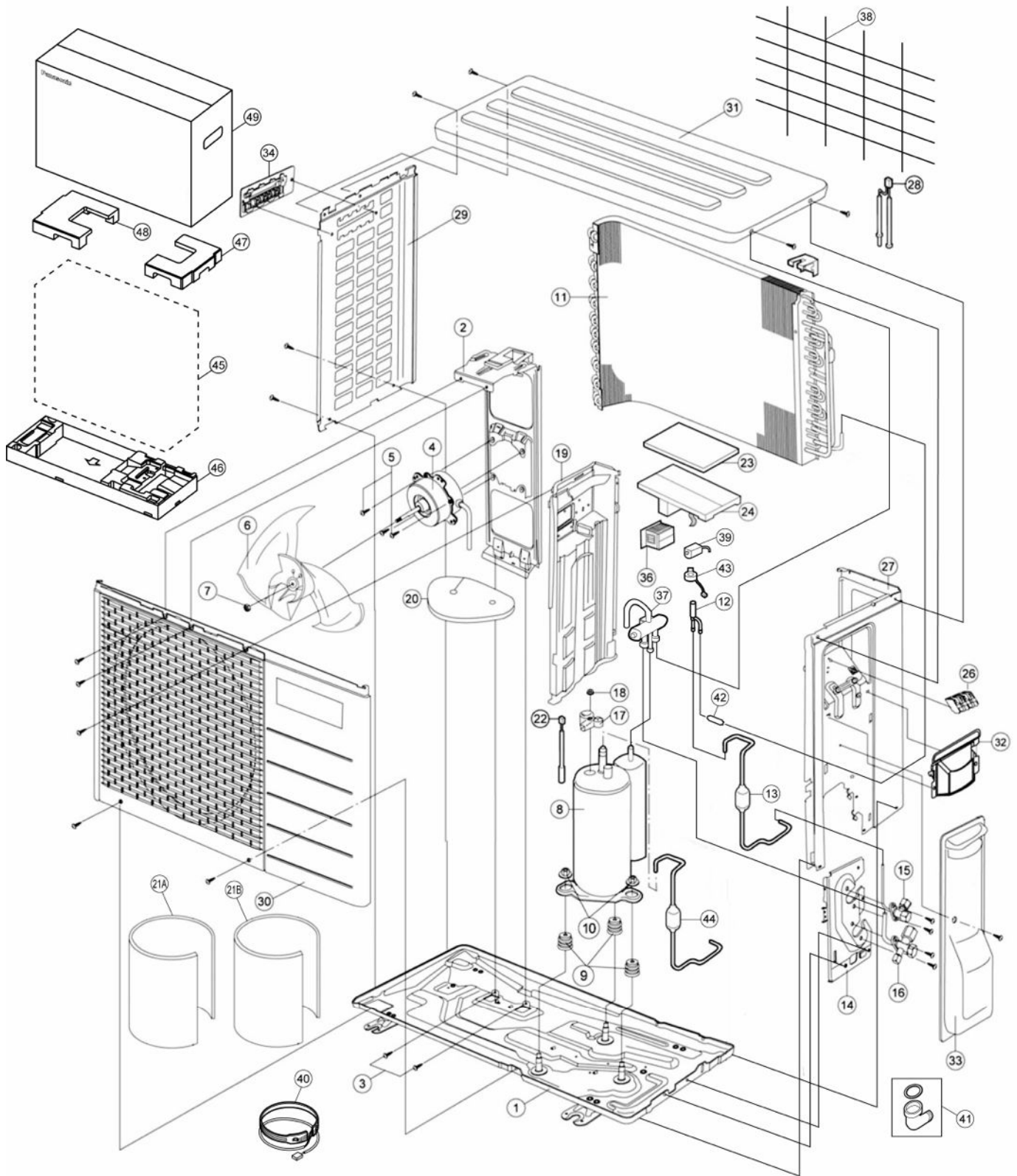

Note

The above exploded view is for the purpose of parts disassembly and replacement.
The non-numbered parts are not kept as standard service parts.

REF. NO.	PART NAME & DESCRIPTION	QTY.	CU-E9NKUA	CU-E12NKUA	REMARK
1	CHASSIS ASSY	1	CWD50K2081A	←	
2	FAN MOTOR BRACKET	1	CWD541089	←	
3	SCREW - FAN MOTOR BRACKET	2	CWH551217	←	
4	FAN MOTOR	1	ARW6404AC	←	O
5	SCREW - FAN MOTOR MOUNT	4	CWH55252J	←	
6	PROPELLER FAN ASSY	1	CWH03K1014	←	
7	NUT - PROPELLER FAN	1	CWH56053J	←	
8	COMPRESSOR	1	5RS102XHA21	←	O
9	ANTI - VIBRATION BUSHING	3	CWH50077	←	
10	NUT - COMPRESSOR MOUNT	3	CWH56000J	←	
11	CONDENSER	1	CWB32C3394	←	
12	EXPANSION VALVE	1	CWB051016J	←	
13	DISCHARGE MUFFLER (EXP VALVE)	1	CWB121021	←	
14	HOLDER COUPLING	1	CWH351015A	←	
15	2-WAYS VALVE (LIQUID)	1	CWB021333	←	O
16	3-WAY VALVE (GAS)	1	CWB011374	CWB011367	O
17	TERMINAL COVER	1	CWH171039A	←	
18	NUT - TERMINAL COVER	1	CWH7080300J	←	
19	SOUND PROOF BOARD	1	CWH151172A	←	
20	SOUND PROOF MATERIAL	1	CWG302570	←	
21a	SOUND PROOF MATERIAL	1	CWG302292	←	
21b	SOUND PROOF MATERIAL	1	CWG302569	←	
22	SENSOR CO-COMP TEMP	1	CWA50C2340	←	O
23	CONTROL BOARD COVER-TOP	1	CWH131264	←	
24	ELECTRONIC CONTROLLER - MAIN	1	CWA73C6161R	CWA73C6162R	O
26	TERMINAL BOARD ASSY	1	CWA28K1154	←	O
27	CABINET SIDE PLATE CO.	1	CWE04C1226	←	
28	SENSOR CO-AIR TEMP AND PIPE TEMP	1	CWA50C2793	←	O
29	CABINET SIDE PLATE	1	CWE041492A	←	
30	CABINET FRONT PLATE CO.	1	CWE06C1142	←	
31	CABINET TOP PLATE	1	CWE031018A	←	
32	PLATE - C. B. COVER TERMINAL	1	CWH131301	←	
33	CONTROL BOARD COVER CO.	1	CWH13C1208	←	
34	HANDLE	1	CWE161010	←	
36	REACTOR	1	G0C193J00003	G0C193J00004	O
37	4-WAYS VALVE	1	CWB001058	←	O
38	WIRE NET	1	CWD041161A	←	
39	V-COIL COMPLETE	1	CWA43C2432	←	
40	CRANKCASE HEATER	1	CWA341065	←	
41	ACCESSORY CO.(DRAIN ELBOW)	1	CWG87C900	←	
42	STRAINER	1	CWB111061	←	
43	V-COIL COMPLETE (EXP. VALVE)	1	CWA43C2393	←	
44	DISCHARGE MUFFLER (4 W.VALVE)	1	CWB121047	←	
45	BAG	1	CWG861078	←	
46	BASE BOARD - COMPLETE	1	CWG50C2388	←	
47	SHOCK ABSORBER (R)	1	CWG712209	←	
48	SHOCK ABSORBER (L)	1	CWG712210	←	
49	C.C.CASE	1	CWG565107	←	

(Note)

- All parts are supplied from PHAAM, Malaysia (Vendor Code: 00029488).
- "O" marked parts are recommended to be kept in stock.