

TECHNICAL & SERVICE MANUAL

CS-KE12NB41 & CZ-18BT1U + CU-KE12NK1
CS-KE18NB4UW & CZ-18BT1U + CU-KE18NKU

DC INVERTER SPLIT SYSTEM AIR CONDITIONER

Indoor Model No. Body (Panel)	Product Code No. Body (Panel)
CS-KE12NB41 (CZ-18BT1U)	1 852 361 05 (1 852 361 15)
CS-KE18NB4UW (CZ-18BT1U)	1 852 361 07 (1 852 361 15)

Outdoor Model No.	Product Code No.
CU-KE12NK1	1 852 361 17
CU-KE18NKU	1 852 361 20

Indoor Unit

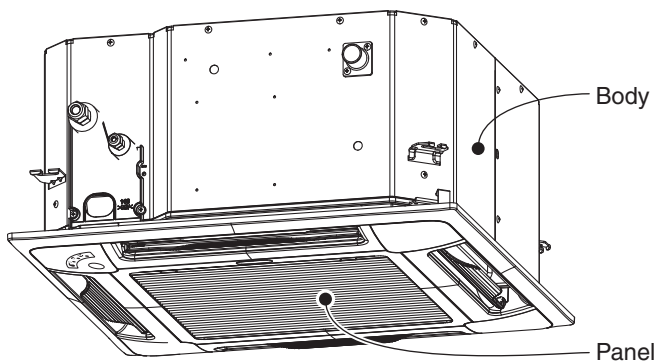

Outdoor Unit

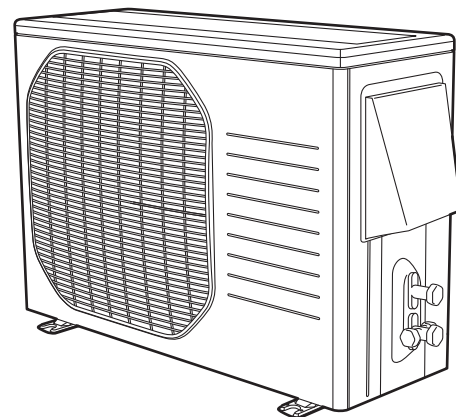

CS-KE12NB41 (Body) & CZ-18BT1U (Panel)
CS-KE18NB4UW (Body) & CZ-18BT1U (Panel)

CU-KE12NK1



Remote Controller





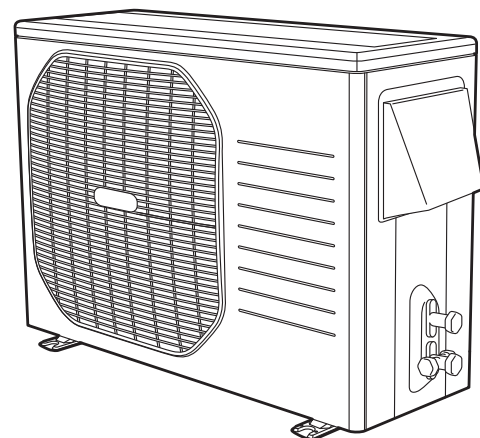





Wired Remote Controller
(Option)

























CU-KE18NKU

R410A

SAFETY PRECAUTIONS

- Before doing repair work, please read the " SAFETY PRECAUTIONS" carefully and fully understand them.
- The precautionary items here are divided into " Warning" and " Caution" items.
Items in particular which may cause death or serious injury to the service personnel if the work is not performed correctly, are included in the " Warning" table.
However, even precautionary items identified as " Caution" also have the potential for serious consequences if not performed correctly.
Important safety precautions are described for all items in both categories. Be sure to carefully follow all of them.
- Symbol Indication
 -  : This symbol indicates items to which we need to pay attention.
In this triangle, a definite precautionary item is described.
 -  : This symbol indicates the item to be prohibited.
In or close to this circle, a prohibited item is described.
 -  : This symbol indicates the items requiring special attention or instruction.
In or close to this circle, a prohibited item is described.
- After doing repair work, perform a test run to confirm that there are no abnormalities.
At the same time, explain the precautions in use to the user.

 Warning	
Before performing an overhaul, disconnect the power plug or power cable from the unit. Performing the work with the power supplied to the unit, may cause an electric shock.	
When repair work or circuit inspection that requires power supply for the air conditioner, is to be performed, do not touch the charging section. Doing so may cause an electric shock.	 Prohibit
For the step-up capacitor attached to the electric section, perform the repair work after sufficiently discharging it. Insufficient capacitor discharge may cause an electric shock.	
Do not perform repair work on the electric sections with wet hands. Doing so may cause an electric shock.	 Prohibit
Do not start or stop the air conditioner by means of connecting or disconnecting the power plug. Doing so may cause an electric shock or fire.	 Prohibit
When conducting repair work only use components included in the parts list for the corresponding unit and perform the work with the appropriate tools. Incorrect or poor repair work may cause an electric shock or fire.	
Never modify the unit. Doing so may cause an electric shock or fire.	 Prohibit
Perform all electric work according to local applicable regulations related to electrical equipment or interior wiring regulation and make sure to use the exclusive circuit. Insufficient capacity to the electric circuit or defective arrangement results may cause an electric shock or fire.	
Make sure to replace any power cable or lead wire showing any signs of scratch or deterioration. Failure to do so may cause an electric shock, overheating or fire.	
Make sure that there is no dust on or slack in the power plug and insert fully into the socket. Dust or incomplete connections may cause an electric shock or fire.	
Do not damage or process the power cord, as it may cause an electric shock or fire.	 Prohibit
For the wiring between the indoor unit and outdoor unit, securely fix the specified cable onto the terminal plate. Poorly fixed wiring may cause a heat or fire.	
After connecting the wiring between the indoor unit and outdoor unit, attach the terminal cover securely. Incomplete attachment of the terminal cover may cause overheating or fire.	

 Warning	
If refrigerant gas blows off during the work, do not touch the refrigerant gas as it may cause frostbite.	 Prohibit
If refrigerant gas leaks during the work, ventilate the room. If refrigerant gas catches fire, harmful gas may be generated.	
Do not mix any gas other than the specified refrigerant gas in the refrigerating cycle. If air or other contaminants mix with the gas, pressure will become extremely high in the refrigerating cycle, which may cause a unit breakdown."	 Prohibit
When the welded section of the compressor intake or discharge pipe is to be disconnected, perform it in a well-ventilated place after sufficiently recovering the refrigerant gas. Any residue gas may jet out refrigerant or refrigerating machine oil, which may cause an injury.	
When the work is to be performed in a high place (About 2 meters or more), make sure to wear a safety helmet, gloves and safety belt. Insufficient safety gear may cause a serious injury in case of a fall.	
When the unit is to be relocated, confirm that the new installation location has sufficient strength for the weight of the unit. Insufficient strength of the installation location and incomplete installation work may cause an injury due to the unit falling.	
When the remote controller batteries are replaced, dispose of the old batteries out of the reach of children. If a child swallows a battery, make sure that the child gets immediate medical attention.	













 Caution	
Do not wash the air conditioner with water, as this may cause an electric shock or fire.	 Prohibit
For the repair work in places with high humidity or moisture, make sure to ground the unit. Failure to do so may cause an electric shock.	
Confirm that the component attachment position, wiring condition, soldering condition and connector connection are normal. If not, it may cause overheating or fire.	
Confirm that the temperature around the compressor is not too high, and then perform the repair work. Failure to do so may cause a burn.	
Perform welding work in a place with good ventilation. If the work is performed in a poorly ventilated area, it might cause a lack of oxygen.	
If the installation plate or attachment frame has deteriorated due to corrosion, etc., replace it. Failure to do so may cause an injury due to the unit falling.	
When the cleaning is to be performed, make sure to turn off the power and pull out the plug. Touching the fan that is rotating at high speed may result in an injury.	
When the indoor unit is to be removed, do not place it on an incline. Doing so may cause wet furniture because water left inside may trickle down.	 Prohibit
Do not hold the sharp end of the unit or the aluminum fins, as it may cause an injury to your hand or finger.	 Prohibit
After repairs, make sure to measure the insulation resistance and confirm that the value is 1 Mohm or more. Any insulation error may cause an electric shock.	
After repairs, make sure to check the drainage of the indoor unit. Inappropriate drainage may cause wet furniture and floors due to water leakage.	

Table of Contents

	Page
⚠ SAFETY PRECAUTIONS	2
TABLE OF CONTENTS	4
1. OPERATING RANGE	6
2. SPECIFICATIONS	
2-1. Unit Specifications	7
2-2. Major Component Specifications	13
2-3. Other Component Specifications	17
3. DIMENSIONAL DATA	18
4. REFRIGERANT FLOW DIAGRAM	
4-1. Refrigerant Flow Diagram	21
5. PERFORMANCE DATA	
5-1. Temperature Charts	23
5-2. Cooling Capacity	27
5-3. Cooling Capacity (Low Ambient)	29
5-4. Heating Capacity	31
6. ELECTRICAL DATA	
6-1. Electrical Characteristics	33
6-2. Electric Wiring Diagrams	35
7. MAINTENANCE	
7-1. Address Setting of the Remote Control Unit	38
7-2. Disconnecting and Connecting Positive Connector for Outdoor Unit	39
7-3. Disassembly Procedure	40
8. FUNCTIONS	
8-1. Operation Functions	47
8-2. Protective Functions	49
9. TROUBLESHOOTING (BEFORE CALLING FOR SERVICE)	
9-1. Precautions before Performing Inspection or Repair	51
9-2. Method of Self-Diagnostics	51
9-3. Checking the Indoor and Outdoor Units	53
9-4. Trouble Diagnosis of Fan Motor	57
9-5. Noise Malfunction and Electromagnetic Interference	59

10. CHECKING ELECTRICAL COMPONENTS

10-1. Measurement of Insulation Resistance	60
10-2. Checking Continuity of Fuse on PCB Ass'y	61

11. REFRIGERANT R410A:**SPECIAL PRECAUTIONS WHEN SERVICING UNIT**

11-1. Characteristics of New Refrigerant R410A	62
11-2. Checklist before Servicing	63
11-3. Tools Specifically for R410A	64
11-4. Tubing Installation Procedures	64
11-5. In Case of Compressor Malfunction	65
11-6. In Case Refrigerant is Leaking	67
11-7. Charging Additional Refrigerant	68
11-8. Retro-Fitting Existing Systems	68

APPENDIX A Operating Instructions	A-1
(CS-KE12NB41 & CZ-18BT1U + CU-KE12NK1 CS-KE18NB4UW & CZ-18BT1U + CU-KE18NKU)	

APPENDIX B INSTALLATION INSTRUCTIONS	A-2
(CS-KE12NB41 & CZ-18BT1U + CU-KE12NK1 CS-KE18NB4UW & CZ-18BT1U + CU-KE18NKU)	

APPENDIX C Operating Instructions	A-3
(CZ-RD515U)	

APPENDIX D INSTALLATION INSTRUCTIONS	A-4
(CZ-RD515U)	

1. OPERATING RANGE

	Temperature	Indoor Air Intake Temp.	Outdoor Air Intake Temp.
Cooling	Maximum	95 °F DB / 71 °F WB	115 °F DB
	Minimum	67 °F DB / 57 °F WB	0 °F DB
Heating	Maximum	80 °F DB / 67 °F WB	75 °F DB / 65 °F WB
	Minimum	– DB / – WB	– DB / 0 °F WB

2. SPECIFICATIONS

2-1. Unit Specifications

2-1-1. Indoor Unit **CS-KE12NB41 & CZ-18BT1U**
 Outdoor Unit **CU-KE12NK1**

Voltage Rating			115V Single-Phase 60Hz		
Performance			Cooling	Heating	
	Total Capacity	BTU/h kW	11,900 (3,000 to 11,900) 3.5 (0.9 to 3.5)	13,600 (3,000 to 13,600) 4.0 (0.9 to 4.0)	
	Sensible Capacity	BTU/h	7,200	-	
	Latent Capacity	BTU/h	4,700	-	
	Air Circulation (Hi/Me/Lo)	ft ³ /min (m ³ /h)	235(399) / 206(350) / 194(330)	268(455) / 247(420) / 224(381)	
	Moisture Removal (High)	Pints/h	4.26	-	
Electrical Rating	Available Voltage Range		V 104 to 126		
	Running Amperes	A	12.6 (2.5 to 12.6)	14.6 (2.5 to 14.6)	
	Power Input	W	1,260 (250 to 1,260)	1,460 (250 to 1,460)	
	Power Factor	%	87	87	
	EER	BTU/h/W	9.44	-	
	COP	W/W	-	2.74	
	SEER	BTU/Wh	16	-	
	HSPF	BTU/Wh	-	8.5	
	Compressor Locked Rotor Amperes	A	20		
	Fuse or Circuit Breaker Capacity	A	20		
Features	Controls / Temperature Control		Microprocessor / I.C. Thermister		
	Control Unit		Wireless Remote Control Unit		
	Timer		24-Hour ON or OFF Timer, 1-Hour OFF Timer		
	Fan Speeds	Indoor / Outdoor	Auto and 3 steps / Auto (Hi, Me, Lo)		
	Airflow Direction (Indoor)	Horizontal	-		
		Vertical	Auto		
	Air Filter		Washable, Anti-Mold		
	Compressor		DC Rotary (Inverter)		
	Refrigerant / Amount charged at shipment	lbs (g)	R410A / 2.43 (1,100)		
	Refrigerant Control		Electric Expansion Valve		
	Operation Sound	Indoor : Hi/Me/Lo	dB-A	34 / 32 / 31	35 / 34 / 32
		Outdoor : Hi	dB-A	47	49
	Refrigerant Tubing Connections		Flare Type		
	Max. allowable tubing length at shipment	ft (m)	25 (7.5)		
	Refrigerant	Narrow tube	inch (mm)	1/4 (6.35)	
	Tube Diameter	Wide tube	inch (mm)	3/8 (9.52)	
Wired Remote Controller (Option)		CZ-RD515U			

Indoor Unit **CS-KE12NB41 & CZ-18BT1U**
 Outdoor Unit **CU-KE12NK1**

Dimensions & Weight (Indoor Unit)			Indoor Unit (CS-KE12NB41 & CZ-18BT1U)	Individual Unit	
				Body (CS-KE12NB41)	Panel (CZ-18BT1U)
Unit Dimensions	Height	inch (mm)	12-5/16 (313)	11-5/32 (283)	1-9/16 (40)
	Width	inch (mm)	24-19/32 (625)	22-5/8 (575)	24-19/32 (625)
	Depth	inch (mm)	24-19/32 (625)	22-5/8 (575)	24-19/32 (625)
Package Dimensions	Height	inch (mm)	-	11-13/32 (290)	4-1/8 (105)
	Width	inch (mm)	-	24-13/16 (630)	26-3/16 (665)
	Depth	inch (mm)	-	28-1/8 (714)	26-11/16 (678)
Weight	Net	lb. (kg)	41.3 (18.7)	35.3 (16)	6.0 (2.7)
	Shipping	lb. (kg)	-	41.9 (19)	7.7 (3.5)
Shipping Volume		cu.ft (m ³)	-	4.59 (0.13)	1.65 (0.04)

Dimensions & Weight (Outdoor Unit)			Outdoor Unit (CU-KE12NK1)
Unit Dimensions	Height	inch (mm)	21-9/16 (548)
	Width	inch (mm)	28-11/32 (720)
	Depth	inch (mm)	10-7/16 (265)
Package Dimensions	Height	inch (mm)	23-15/32 (596)
	Width	inch (mm)	34-3/32 (866)
	Depth	inch (mm)	14-1/2 (368)
Weight	Net	lb. (kg)	77.2 (35.0)
	Shipping	lb. (kg)	83.8 (38.0)
Shipping Volume		cu.ft (m ³)	6.35 (0.18)

DATA SUBJECT TO CHANGE WITHOUT NOTICE.

Remarks: Rating conditions are:

Cooling: Indoor air temperature 80 °F DB / 67 °F WB
 Outdoor air temperature 95 °F DB / 75 °F WB

Heating: Indoor air temperature 70 °F DB
 Outdoor air temperature 47 °F DB / 43 °F WB

2-1-2. Indoor Unit CS-KE18NB4UW & CZ-18BT1U
Outdoor Unit CU-KE18NKU

< 230V >

Voltage Rating		230V Single-Phase 60Hz			
Performance	Total Capacity	BTU/h	Cooling	Heating	
		kW	17,500 (4,000 to 17,500)	20,400 (4,400 to 20,400)	
	Sensible Capacity	BTU/h	10,600	-	
	Latent Capacity	BTU/h	6,900	-	
	Air Circulation (Hi/Me/Lo)	ft ³ /min (m ³ /h)	341(579) / 294(500) / 253(430)	383(651) / 324(551) / 265(450)	
	Moisture Removal (High)	Pints/h	4.89	-	
Electrical Rating	Available Voltage Range	V	187 to 253		
	Running Amperes	A	8.3 (1.2 to 8.3)	10.5 (1.3 to 10.5)	
	Power Input	W	1,860 (250 to 1,860)	2,340 (270 to 2,340)	
	Power Factor	%	97	97	
	EER	BTU/h/W	9.41	-	
	COP	W/W	-	2.56	
	SEER	BTU/Wh	16	-	
	HSPF	BTU/Wh	-	8.5	
	Compressor Locked Rotor Amperes	A	17.5		
	Fuse or Circuit Breaker Capacity	A	15		
Features	Controls / Temperature Control		Microprocessor / I.C. Thermister		
	Control Unit		Wireless Remote Control Unit		
	Timer		24-Hour ON or OFF Timer, 1-Hour OFF Timer		
	Fan Speeds	Indoor / Outdoor	Auto and 3 steps / Auto (Hi, Me, Lo)		
	Airflow Direction (Indoor)	Horizontal	-		
		Vertical	Auto		
	Air Filter		Washable, Anti-Mold		
	Compressor		DC Twin Rotary (Inverter)		
	Refrigerant / Amount charged at shipment	lbs (g)	R410A / 2.87 (1,300)		
	Refrigerant Control		Electric Expansion Valve		
	Operation Sound	Indoor : Hi/Me/Lo	dB-A	44 / 40 / 36	44 / 40 / 36
		Outdoor : Hi	dB-A	51	52
	Refrigerant Tubing Connections		Flare Type		
	Max. allowable tubing length at shipment	ft (m)	25 (7.5)		
	Refrigerant	Narrow tube	inch (mm)	1/4 (6.35)	
	Tube Diameter	Wide tube	inch (mm)	1/2 (12.7)	
Wired Remote Controller (Option)		CZ-RD515U			

Indoor Unit **CS-KE18NB4UW & CZ-18BT1U**
 Outdoor Unit **CU-KE18NKU**

< 230V >

Dimensions & Weight (Indoor Unit)			Indoor Unit (CS-KE18NB4UW & CZ-18BT1U)	Individual Unit	
				Body (CS-KE18NB4UW)	Panel (CZ-18BT1U)
Unit Dimensions	Height	inch (mm)	12-5/16 (313)	11-5/32 (283)	1-9/16 (40)
	Width	inch (mm)	24-19/32 (625)	22-5/8 (575)	24-19/32 (625)
	Depth	inch (mm)	24-19/32 (625)	22-5/8 (575)	24-19/32 (625)
Package Dimensions	Height	inch (mm)	-	11-13/32 (290)	4-1/8 (105)
	Width	inch (mm)	-	24-13/16 (630)	26-3/16 (665)
	Depth	inch (mm)	-	28-1/8 (714)	26-11/16 (678)
Weight	Net	lb. (kg)	41.3 (18.7)	35.3 (16)	6.0 (2.7)
	Shipping	lb. (kg)	-	41.9 (19)	7.7 (3.5)
Shipping Volume		cu.ft (m ³)	-	4.59 (0.13)	1.65 (0.04)

Dimensions & Weight (Outdoor Unit)			Outdoor Unit (CU-KE18NKU)
Unit Dimensions	Height	inch (mm)	26-3/8 (670)
	Width	inch (mm)	34-21/32 (880)
	Depth	inch (mm)	11-7/32 (285)
Package Dimensions	Height	inch (mm)	28-27/32 (733)
	Width	inch (mm)	39-27/32 (1,012)
	Depth	inch (mm)	14-29/32 (379)
Weight	Net	lb. (kg)	97.0 (44.0)
	Shipping	lb. (kg)	105.8 (48.0)
Shipping Volume		cu.ft (m ³)	9.88 (0.28)

DATA SUBJECT TO CHANGE WITHOUT NOTICE.

Remarks: Rating conditions are:

Cooling: Indoor air temperature 80 °F DB / 67 °F WB
 Outdoor air temperature 95 °F DB / 75 °F WB

Heating: Indoor air temperature 70 °F DB
 Outdoor air temperature 47 °F DB / 43 °F WB

2-1-3. Indoor Unit CS-KE18NB4UW & CZ-18BT1U
Outdoor Unit CU-KE18NKU

< 208V >

Voltage Rating			208V Single-Phase 60Hz		
Performance	Total Capacity	BTU/h	Cooling		
		kW	17,500 (4,000 to 17,500)	Heating	
	Sensible Capacity	BTU/h	10,600	-	
	Latent Capacity	BTU/h	6,900	-	
	Air Circulation (Hi/Me/Lo)	ft ³ /min (m ³ /h)	341(579) / 294(500) / 253(430) 383(651) / 324(551) / 265(450)		
	Moisture Removal (High)	Pints/h	4.89	-	
Electrical Rating	Available Voltage Range	V	187 to 253		
	Running Amperes	A	9.1 (1.2 to 9.1)	11.5 (1.3 to 11.5)	
	Power Input	W	1,860 (250 to 1,860)	2,340 (270 to 2,340)	
	Power Factor	%	98	98	
	EER	BTU/h/W	9.41	-	
	COP	W/W	-	2.56	
	SEER	BTU/Wh	16	-	
	HSPF	BTU/Wh	-	8.5	
	Compressor Locked Rotor Amperes	A	17.5		
	Fuse or Circuit Breaker Capacity	A	15		
Features	Controls / Temperature Control		Microprocessor / I.C. Thermister		
	Control Unit		Wireless Remote Control Unit		
	Timer		24-Hour ON or OFF Timer, 1-Hour OFF Timer		
	Fan Speeds	Indoor / Outdoor	Auto and 3 steps / Auto (Hi, Me, Lo)		
	Airflow Direction (Indoor)	Horizontal	-		
		Vertical	Auto		
	Air Filter		Washable, Anti-Mold		
	Compressor		DC Twin Rotary (Inverter)		
	Refrigerant / Amount charged at shipment	lbs (g)	R410A / 2.87 (1,300)		
	Refrigerant Control		Electric Expansion Valve		
	Operation Sound	Indoor : Hi/Me/Lo	dB-A	44 / 40 / 36	44 / 40 / 36
		Outdoor : Hi	dB-A	51	52
	Refrigerant Tubing Connections		Flare Type		
	Max. allowable tubing length at shipment	ft (m)	25 (7.5)		
	Refrigerant	Narrow tube	inch (mm)	1/4 (6.35)	
	Tube Diameter	Wide tube	inch (mm)	1/2 (12.7)	
	Wired Remote Controller (Option)		CZ-RD515U		

Indoor Unit **CS-KE18NB4UW & CZ-18BT1U**
 Outdoor Unit **CU-KE18NKU**

< 208V >

Dimensions & Weight (Indoor Unit)			Indoor Unit (CZ-KE18NB4UW & CZ-18BT1U)	Individual Unit	
				Body (CS-KE18NB4UW)	Panel (CZ-18BT1U)
Unit Dimensions	Height	inch (mm)	12-5/16 (313)	11-5/32 (283)	1-9/16 (40)
	Width	inch (mm)	24-19/32 (625)	22-5/8 (575)	24-19/32 (625)
	Depth	inch (mm)	24-19/32 (625)	22-5/8 (575)	24-19/32 (625)
Package Dimensions	Height	inch (mm)	-	11-13/32 (290)	4-1/8 (105)
	Width	inch (mm)	-	24-13/16 (630)	26-3/16 (665)
	Depth	inch (mm)	-	28-1/8 (714)	26-11/16 (678)
Weight	Net	lb. (kg)	41.3 (18.7)	35.3 (16)	6.0 (2.7)
	Shipping	lb. (kg)	-	41.9 (19)	7.7 (3.5)
Shipping Volume		cu.ft (m ³)	-	4.59 (0.13)	1.65 (0.04)

Dimensions & Weight (Outdoor Unit)			Outdoor Unit (CU-KE18NKU)
Unit Dimensions	Height	inch (mm)	26-3/8 (670)
	Width	inch (mm)	34-21/32 (880)
	Depth	inch (mm)	11-7/32 (285)
Package Dimensions	Height	inch (mm)	28-27/32 (733)
	Width	inch (mm)	39-27/32 (1,012)
	Depth	inch (mm)	14-29/32 (379)
Weight	Net	lb. (kg)	97.0 (44.0)
	Shipping	lb. (kg)	105.8 (48.0)
Shipping Volume		cu.ft (m ³)	9.88 (0.28)

DATA SUBJECT TO CHANGE WITHOUT NOTICE.

Remarks: Rating conditions are:

Cooling: Indoor air temperature 80 °F DB / 67 °F WB
 Outdoor air temperature 95 °F DB / 75 °F WB

Heating: Indoor air temperature 70 °F DB
 Outdoor air temperature 47 °F DB / 43 °F WB

2-2. Major Component Specifications

2-2-1. Indoor Unit

Indoor Unit (Body) **CS-KE12NB41**

Control PCB	
Part No.	CB-CS-KE12NB4U
Controls	Microprocessor
Control Circuit Fuse	250V 3A

Fan	
Type	Turbo
Q'ty ... Dia. and Length	inch (mm) 1 ... D12-5/8 / L5-3/4 (D322/L147)

Fan Motor	
Type	DC Motor
Model ... Q'ty	SIC-62FW-D866-2 ... 1
No. of Poles	8
Rough Measure RPM (Cool / Heat)	470 / 520
Rating	Voltage / Nominal Output DC160V / 23W
Coil Resistance (Ambient Temp. 68 °F (20 °C))	Ohm -
Safety Device	Internal Controller
Type	Over- Current Protection
	Yes
	Over- Heat Protection
	Yes
Run Capacitor	Micro F -
	VAC -

Drain Pump	
Model ... Q'ty	PLD-12115ST-1 ... 1
Rating	Voltage, Hz AC115V, 60Hz
	Input W 10.8
Coil Resistance (Ambient Temp. 68 °F (20 °C))	Ohm 101 +/- 10%
Safety Device	Type Thermal Fuse
	Open °F (°C) 293 (145)

Heat Exchanger Coil	
Coil	Aluminum Plate Fin / Copper Tube
Rows	2
Fins per inch	18.1
Face Area	ft ² (m ²) 2.94 (0.273)

DATA SUBJECT TO CHANGE WITHOUT NOTICE.

Indoor Unit (Panel) **CZ-18BT1U**

Flap Motor	
Type	Stepping Motor
Model ... Q'ty	MPZN-12V ... 2
Rating	DC 12V
Coil Resistance (Ambient Temp. 77 °F (25 °C))	Ohm Each Pair of Terminal : 380 +/- 7%

DATA SUBJECT TO CHANGE WITHOUT NOTICE.

Indoor Unit (Body) **CS-KE18NB4UW**

Control PCB	
Part No.	CB-CS-KE18NB4U
Controls	Microprocessor
Control Circuit Fuse	250V 3A

Fan	
Type	Turbo
Q'ty ... Dia. and Length	inch (mm) 1 ... D12-5/8 / L5-3/4 (D322/L147)

Fan Motor	
Type	DC Motor
Model ... Q'ty	SIC-62FV-D866-2 ... 1
No. of Poles	8
Rough Measure RPM (Cool / Heat)	650 / 720
Rating	Voltage / Nominal Output DC340V / 20W
Coil Resistance (Ambient Temp. 68 °F (20 °C))	Ohm -
Safety Device	Type Thermal Fuse
	Over- Current Protection Yes
	Over- Heat Protection Yes
Run Capacitor	Micro F -
	VAC -

Drain Pump	
Model ... Q'ty	PLD-12230ST-1 ... 1
Rating	Voltage, Hz AC208 to 240V, 60Hz
	Input W 10.8
Coil Resistance (Ambient Temp. 68 °F (20 °C))	Ohm 333 +/- 10%
Safety Device	Type Thermal Fuse
	Open °F (°C) 293 (145)

Heat Exchanger Coil	
Coil	Aluminum Plate Fin / Copper Tube
Rows	2
Fins per inch	18.1
Face Area	ft ² (m ²) 2.94 (0.273)

DATA SUBJECT TO CHANGE WITHOUT NOTICE.

Indoor Unit (Panel) **CZ-18BT1U**

Flap Motor	
Type	Stepping Motor
Model ... Q'ty	MP24ZN-12V ... 2
Rating	DC 12V
Coil Resistance (Ambient Temp. 77 °F (25 °C))	Ohm Each Pair of Terminal : 380 +/- 7%

DATA SUBJECT TO CHANGE WITHOUT NOTICE.

2-2-2. Outdoor Unit

Outdoor Unit **CU-KE12NK1**

Control PCB	
Part No.	CB-CU-KE12NK1
Controls	Microprocessor
Control Circuit Fuse	125V 25A

Compressor	
Type	DC Rotary (Hermetic)
Compressor Model / Nominal Output	G4C090LU1ER / 900W
Compressor Oil ... Amount	Pints (cc) FV50S ... 0.68 (320)
Coil Resistance (Ambient Temp. 68 °F (20 °C))	Ohm U - V : 0.81 V - W : 0.81 W - U : 0.81
Safety Device	
CT (Peak current cut-off control)	Yes
Compressor Discharge Temp. Control	Yes
Operation cut-off control in abnormal ambient Temp.	Yes
Overload Relay	Model CS-7L115
	Operation Temp. Open : 239 °F (115 °C), Close : 203 °F (95 °C)
Run Capacitor	Micro F -
	VAC -
Crankcase Heater	115V 20W

Fan	
Type	Propeller
Q'ty ... Dia.	inch (mm) 1 ... D15-3/4 (D400)

Fan Motor	
Type	DC Motor
Model ... Q'ty	SIC-67FV-F460-1... 1
No. of Poles	8
Rough Measure RPM (Cool / Heat)	750 / 750
Nominal Output	W 50
Coil Resistance	Ohm RED - WHT : 77.5 WHT - BLU : 77.5 BLU - RED : 77.5
(Ambient Temp. 68 °F (20 °C))	
Safety Device	
Type	Internal Controller
Over- Current Protection	Yes
Run Capacitor	Micro F -
	VAC -

Heat Exchanger Coil	
Coil	Aluminum Plate Fin / Copper Tube
Rows	2
Fins per inch	18.1
Face Area	ft ² (m ²) 3.95 (0.367)

External Finish	Acrylic baked-on enamel finish
------------------------	--------------------------------

DATA SUBJECT TO CHANGE WITHOUT NOTICE.

Outdoor Unit **CU-KE18NKU**

Control PCB	
Part No.	CB-CU-KE18NKU
Controls	Microprocessor
Control Circuit Fuse	250V 25A

Compressor	
Type	DC Twin Rotary (Hermetic)
Compressor Model / Nominal Output	C-6RVN93H0M / 1,050W
Compressor Oil ... Amount Pints (cc)	FV50S ... 0.74 (350)
Coil Resistance (Ambient Temp. 68 °F (20 °C)) Ohm	R - S : 0.482 S - T : 0.482 T - R : 0.482
Safety Device	
CT (Peak current cut-off control)	Yes
Compressor Discharge Temp. Control	Yes
Operation cut-off control in abnormal ambient Temp.	Yes
Overload Relay Model	CS-7L115
Operation Temp.	Open : 239 °F (115 °C), Close : 203 °F (95 °C)
Run Capacitor Micro F	-
VAC	-
Crankcase Heater	-

Fan	
Type	Propeller
Q'ty ... Dia. inch (mm)	1 ... D16-17/32 (D420)

Fan Motor	
Type	DC Motor
Model ... Q'ty	SIC-67FV-F460-1 ... 1
No. of Poles	8
Rough Measure RPM (Cool / Heat)	820 / 850
Nominal Output W	50
Coil Resistance Ohm (Ambient Temp. 68 °F (20 °C))	RED - WHT : 77.5 WHT - BLU : 77.5 BLU - RED : 77.5
Safety Device	
Type	Internal Controller
Over- Current Protection	Yes
Run Capacitor Micro F	-
VAC	-

Heat Exchanger Coil	
Coil	Aluminum Plate Fin / Copper Tube
Rows	2
Fins per inch	21.2
Face Area ft ² (m ²)	5.49 (0.510)

External Finish	Acrylic baked-on enamel finish
------------------------	--------------------------------

DATA SUBJECT TO CHANGE WITHOUT NOTICE.

2-3. Other Component Specifications

Indoor Unit **CS-KE12NB41 & CZ-18BT1U**
CS-KE18NB4UW & CZ-18BT1U

Outdoor Unit **CU-KE12NK1**
CU-KE18NKU

- **Indoor air temp sensor**
 (Model:KTEC-35-S98)

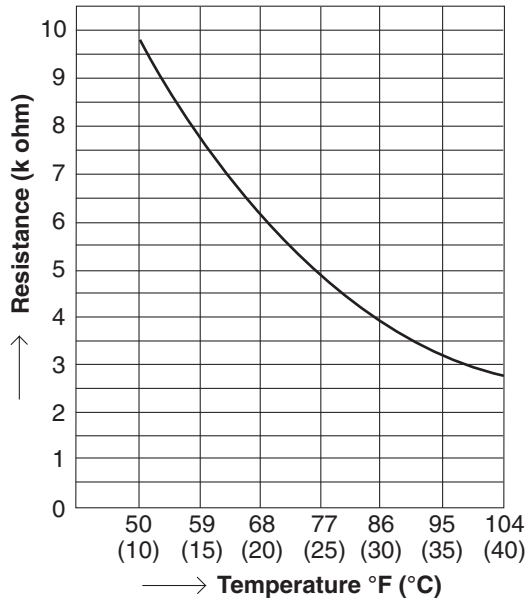

- **Indoor heat exchanger sensor**
 (Model:PT2M-51H-S3)
- **Compressor temp sensor**
 (CU-KE12NK1...Model:DTN-TKS274Y TH2)
 (CU-KE18NKU...Model:DTN-TKS293B)

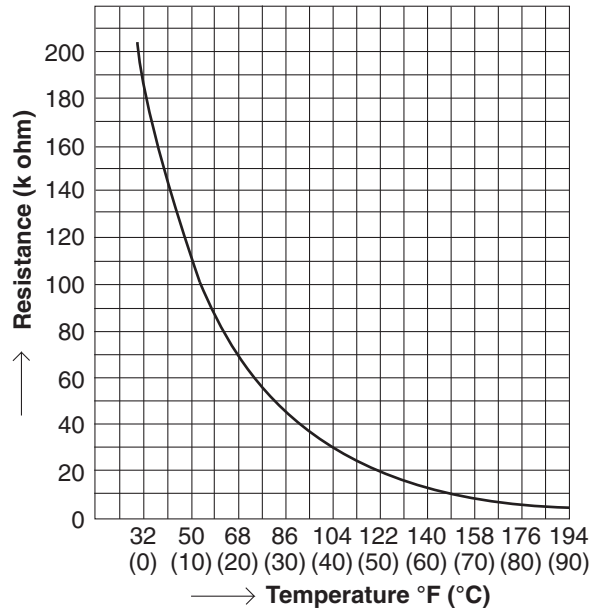

- **Outdoor air temp sensor**
 (CU-KE12NK1...Model:DTN-TKS269B)
 (CU-KE18NKU...Model:TKS295B)
- **Outdoor heat exchanger sensor**
 (CU-KE12NK1...Model:DTN-TKS274Y TH1)
 (CU-KE18NKU...Model:TKS292B)

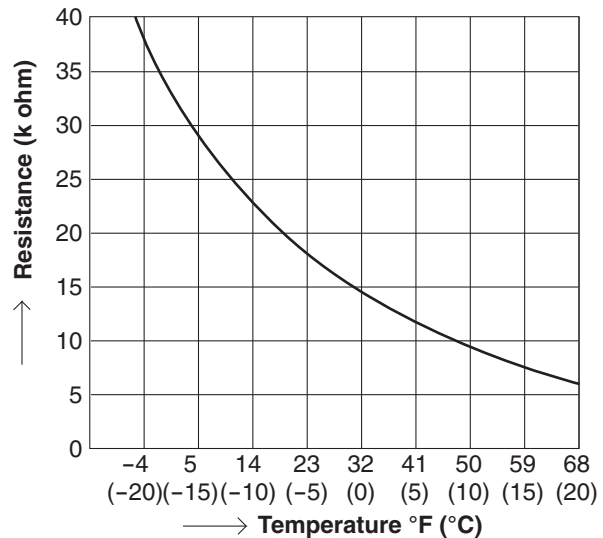

3. DIMENSIONAL DATA

Indoor Unit **CS-KE12NB41 & CZ-18BT1U**
CS-KE18NB4UW & CZ-18BT1U

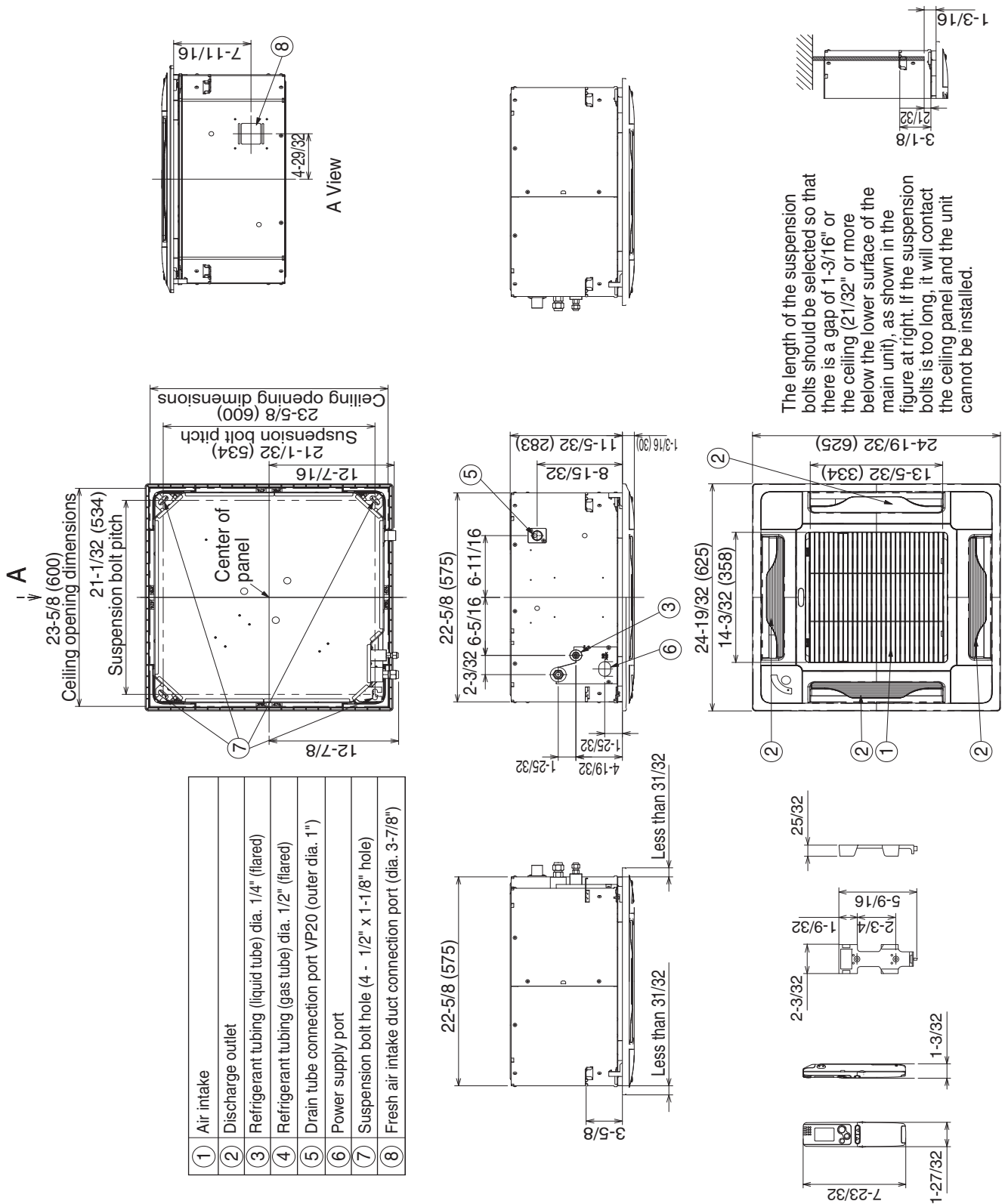

Unit : inch (mm)

Outdoor Unit **CU-KE12NK1**

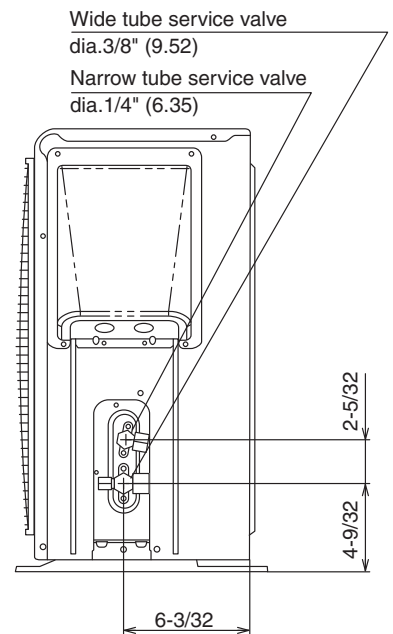
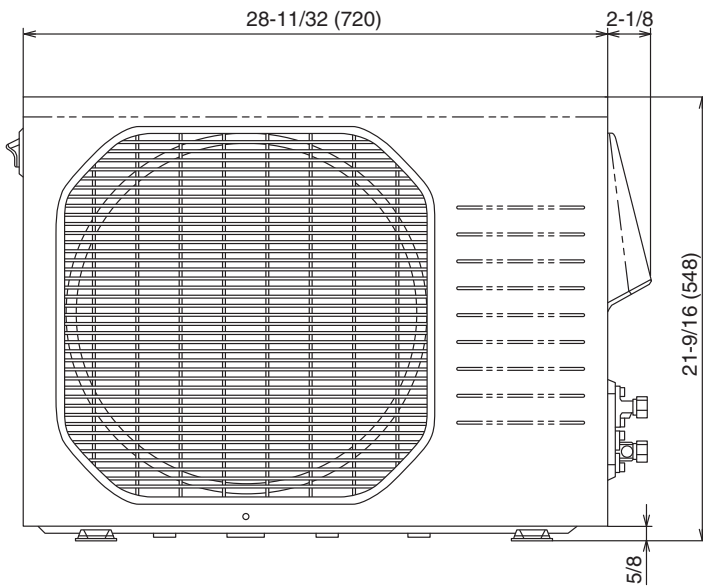
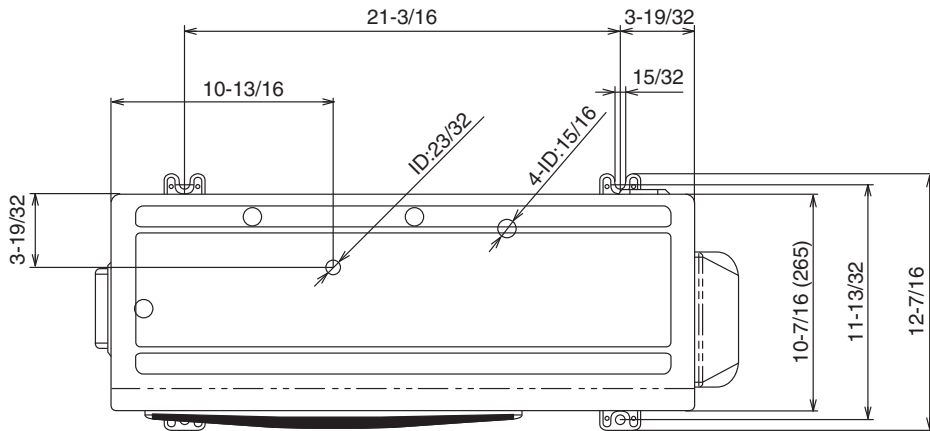

Unit : inch (mm)
(852-0-0010-12700-0)

Outdoor Unit **CU-KE18NKU**

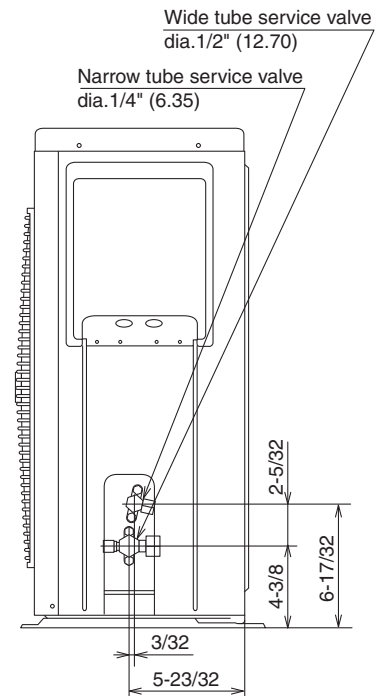
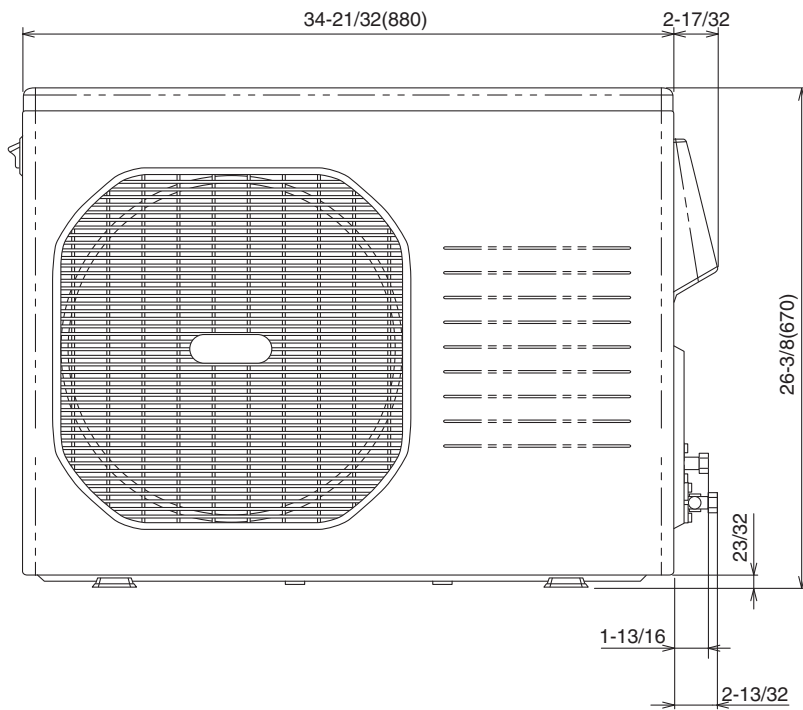
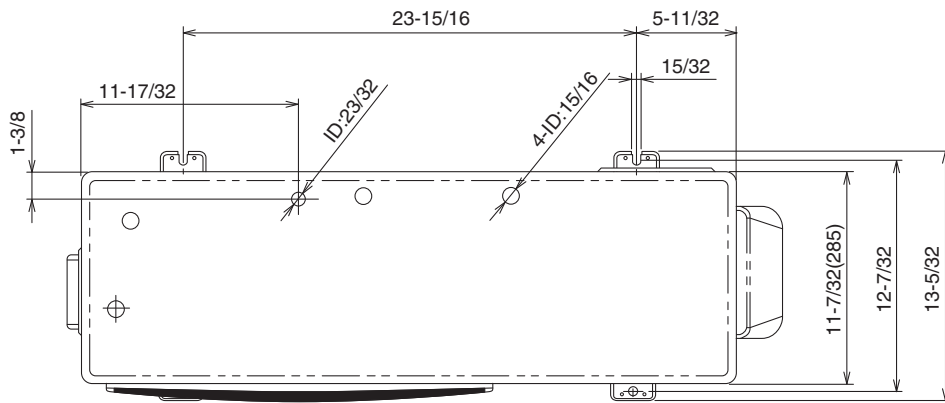

Unit : inch (mm)
(852-0-0010-13200-0)

4. REFRIGERANT FLOW DIAGRAM

4-1. Refrigerant Flow Diagram

Indoor Unit CS-KE12NB41 & CZ-18BT1U

Outdoor Unit CU-KE12NK1

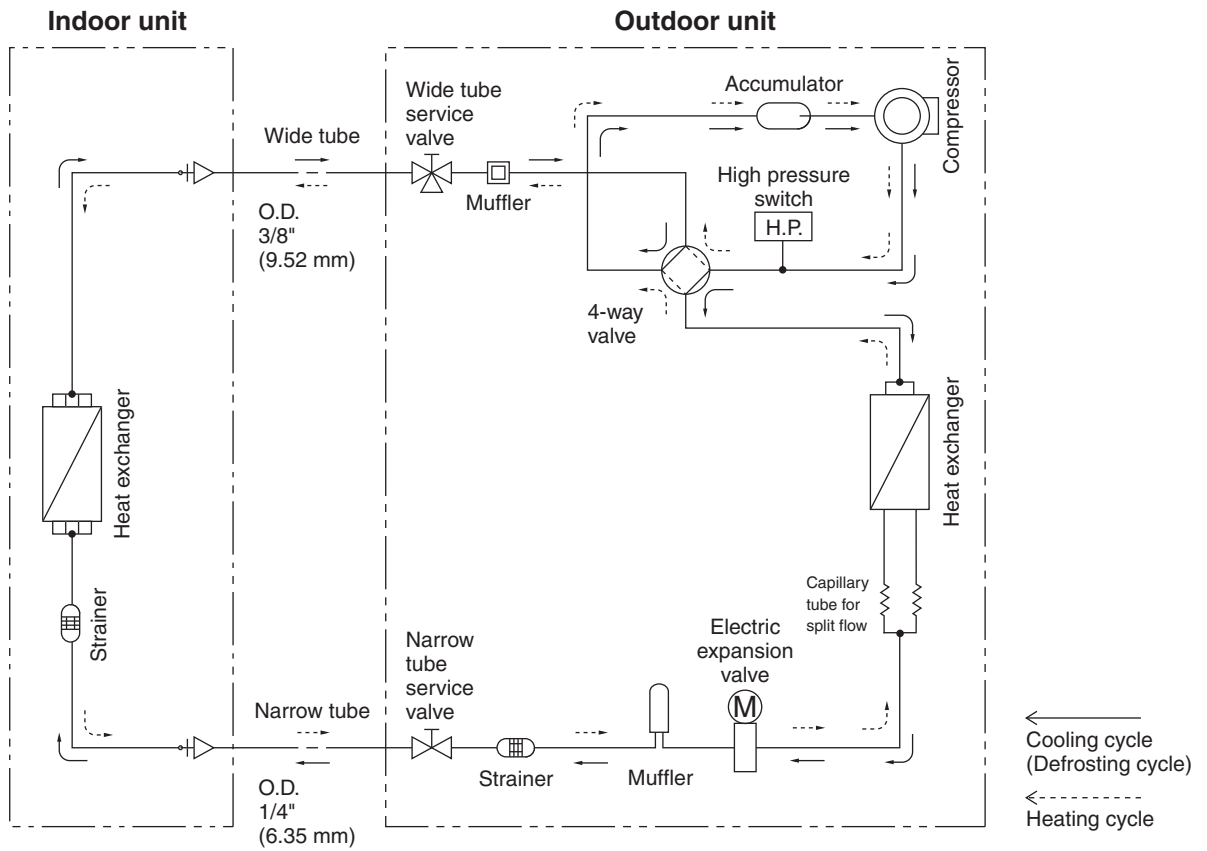

Indoor Unit **CS-KE18NB4UW & CZ-18BT1U** Outdoor Unit **CU-KE18NKU**

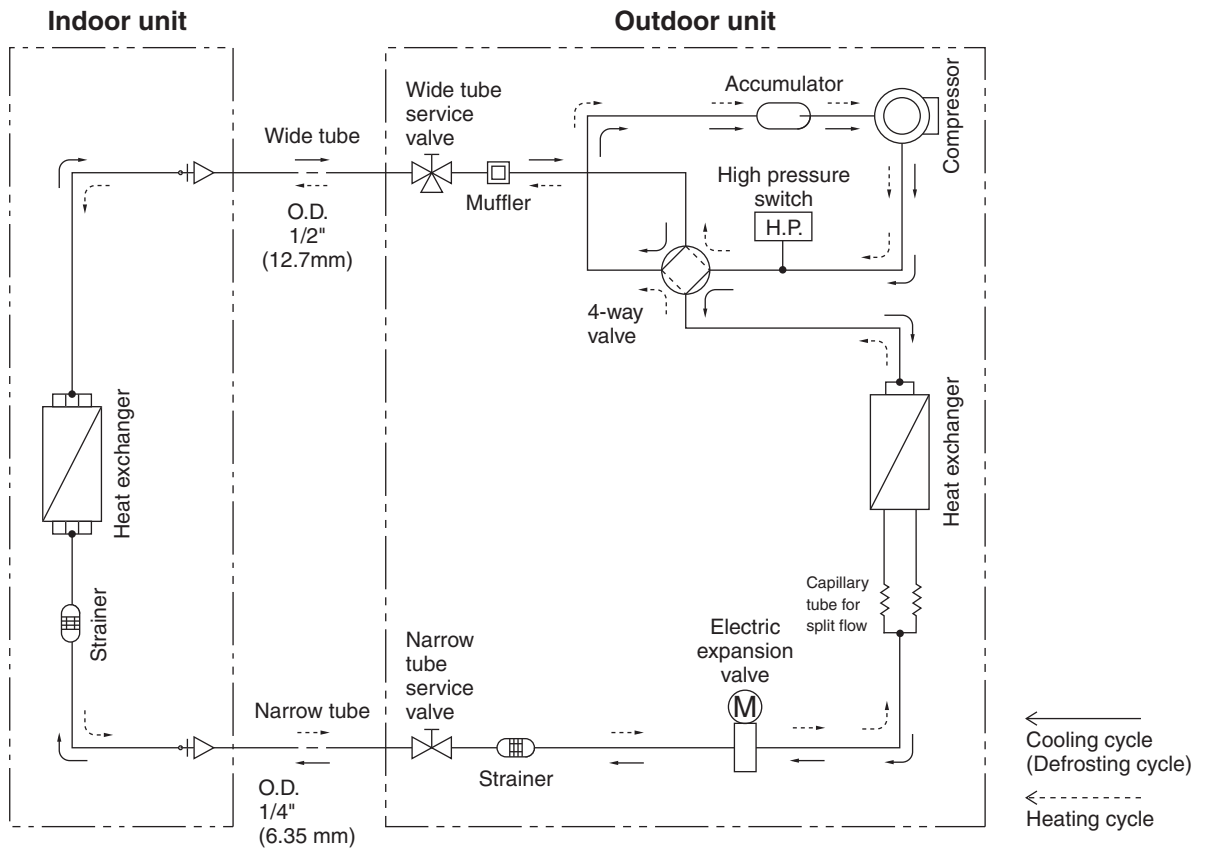

5. PERFORMANCE DATA

5-1. Temperature Charts

Indoor Unit **CS-KE12NB41 & CZ-18BT1U** Outdoor Unit **CU-KE12NK1**

■ Cooling Characteristics (RH : 46%, Indoor fan speed : High fan) (60Hz, 115V)

(1) Low pressure performance chart

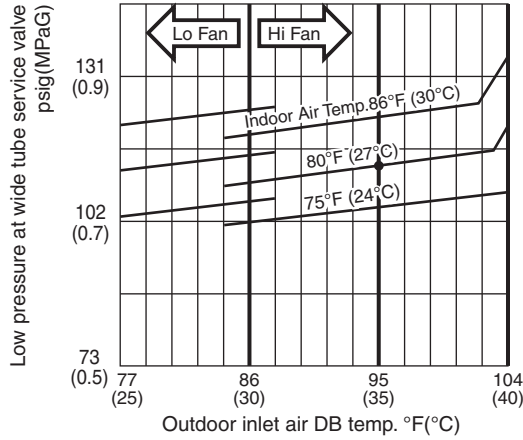

(2) Operating current performance chart

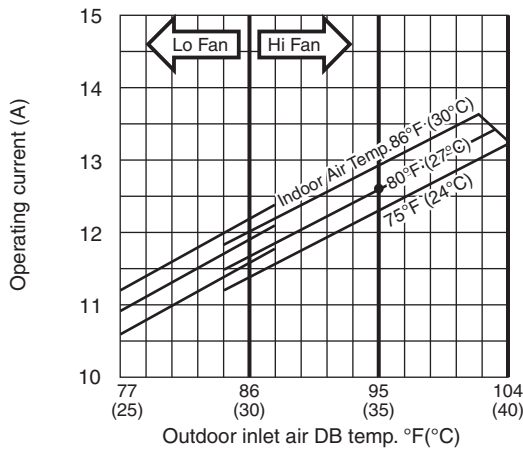

(3) Indoor discharge air performance chart

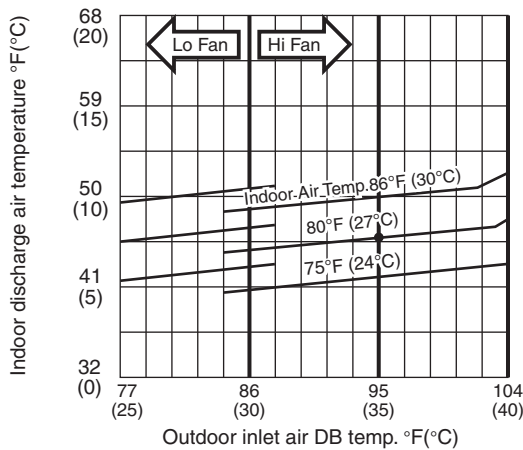

NOTE

• Check each performance value in test-run mode. Electrical performance values represent a combined indoor/outdoor value.

Indoor Unit **CS-KE12NB41 & CZ-18BT1U** Outdoor Unit **CU-KE12NK1**

■ Heating Characteristics (RH : 85%, Indoor fan speed : High fan) (60Hz, 115V)

(1) High pressure performance chart

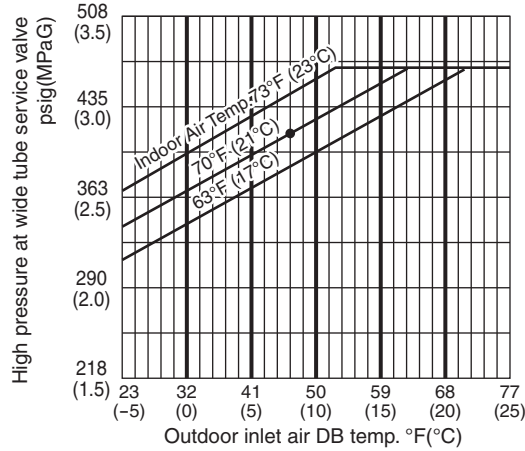

(2) Operating current performance chart

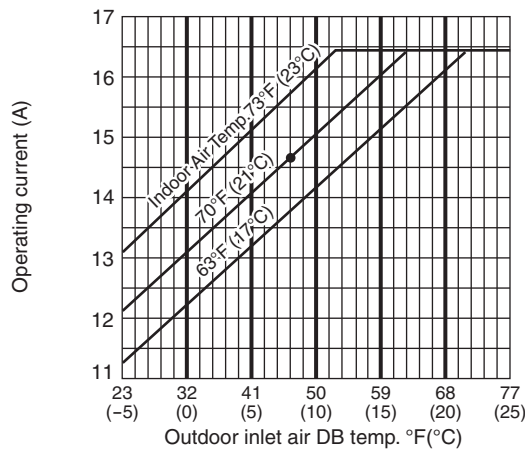

(3) Indoor discharge air performance chart

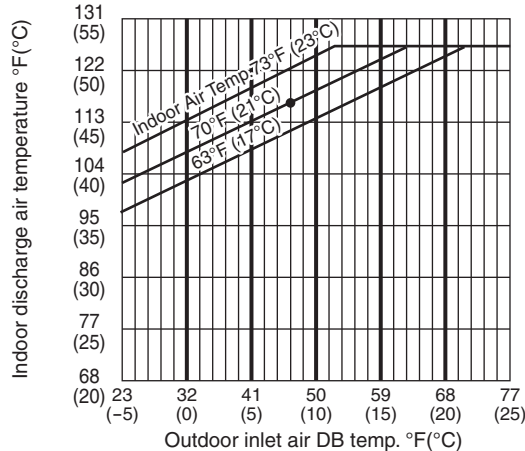

NOTE

- Check each performance value in test-run mode. Electrical performance values represent a combined indoor/outdoor value.
- Overload prevention operates to protect the air conditioner when outdoor ambient temperature becomes extremely high in heating mode. (Refer to "8-2. Protective Functions ■ Overload prevention during heating.")

Indoor Unit **CS-KE18NB4UW & CZ-18BT1U** Outdoor Unit **CU-KE18NKU**

■ Cooling Characteristics (RH : 46%, Indoor fan speed : High fan) (60Hz, 230V)

(1) Low pressure performance chart

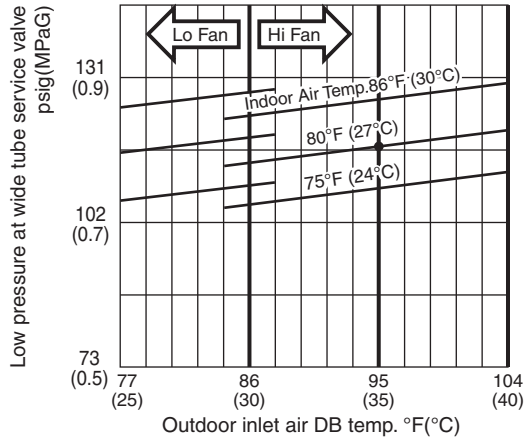

(2) Operating current performance chart

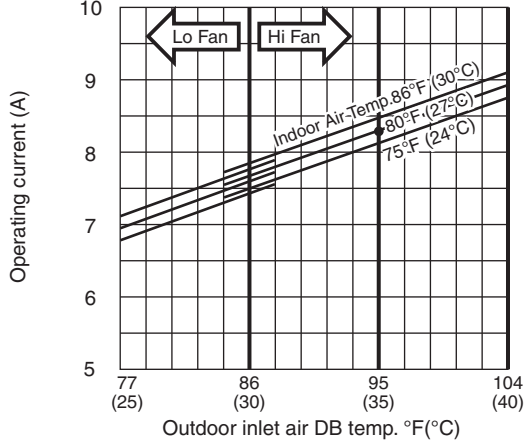

(3) Indoor discharge air performance chart

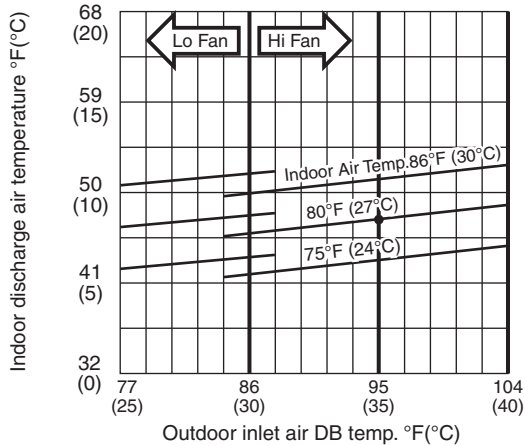

NOTE

• Check each performance value in test-run mode. Electrical performance values represent a combined indoor/outdoor value.

Indoor Unit **CS-KE18NB4UW & CZ-18BT1U** Outdoor Unit **CU-KE18NKU**

■ Heating Characteristics (RH : 85%, Indoor fan speed : High fan) (60Hz, 230V)

(1) High pressure performance chart

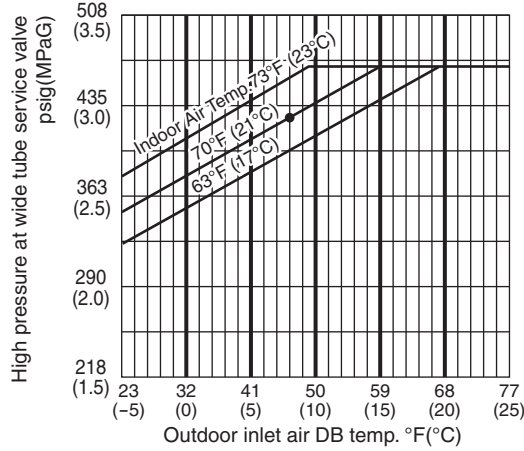

(2) Operating current performance chart

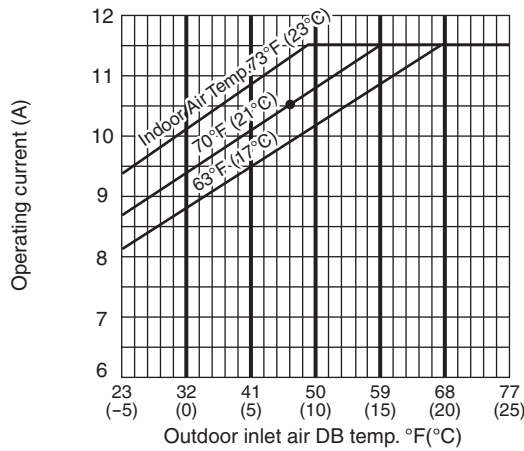

(3) Indoor discharge air performance chart

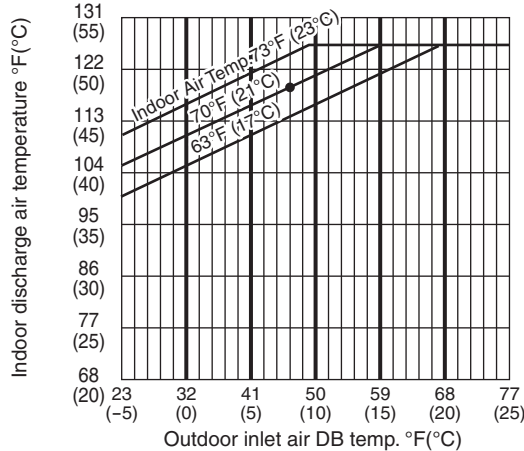

NOTE

- Check each performance value in test-run mode. Electrical performance values represent a combined indoor/outdoor value.
- Overload prevention operates to protect the air conditioner when outdoor ambient temperature becomes extremely high in heating mode. (Refer to "8-2. Protective Functions ■ Overload prevention during heating.")

5-2. Cooling Capacity

Indoor Unit : **CS-KE12NB41 & CZ-18BT1U**

Outdoor Unit : **CU-KE12NK1**

Power Supply : 115V Single Phase 60Hz

< Cooling Capacity >

RATING CAPACITY:		11,900 BTU/h		AIR FLOW RATE:		235 CFM		
INDOOR		OUTDOOR						
ENT. TEMP. °F (°C)		AMBIENT TEMP. °F (°C)						
WB	DB		65 (18.3)	75 (23.9)	85 (29.4)	95 (35.0)	105 (40.6)	115 (46.1)
59 (15.0)		TC	8,350	8,570	8,800	8,930	9,210	7,830
	72 (22.2)	SHC	6,340	6,430	6,570	6,610	6,800	6,060
	76 (24.4)	SHC	7,210	7,300	7,440	7,480	7,660	6,930
	80 (26.7)	SHC	8,120	8,210	8,350	8,400	8,530	7,830
	84 (28.9)	SHC	8,350	8,570	8,800	8,930	9,210	7,830
	88 (31.1)	SHC	8,350	8,570	8,800	8,930	9,210	7,830
63 (17.2)		TC	12,230	12,030	11,790	11,580	10,580	7,950
	72 (22.2)	SHC	7,070	6,930	6,840	6,700	6,200	4,970
	76 (24.4)	SHC	7,940	7,800	7,710	7,570	7,070	5,840
	80 (26.7)	SHC	8,850	8,720	8,580	8,490	7,980	6,750
	84 (28.9)	SHC	9,720	9,590	9,450	9,360	8,850	7,620
	88 (31.1)	SHC	10,590	10,450	10,360	10,230	9,720	7,950
67 (19.4)		TC	12,460	12,290	12,070	# 11,900	10,700	8,040
	72 (22.2)	SHC	5,790	5,700	5,610	5,520	4,970	3,870
	76 (24.4)	SHC	6,660	6,570	6,480	6,380	5,880	4,740
	80 (26.7)	SHC	7,570	7,480	7,390	7,300	6,750	5,650
	84 (28.9)	SHC	8,440	8,350	8,260	8,170	7,620	6,520
	88 (31.1)	SHC	9,310	9,220	9,130	9,040	8,490	7,390
71 (21.7)		TC	12,640	12,490	12,300	12,170	10,770	8,100
	72 (22.2)	SHC	4,460	4,420	4,330	4,280	3,690	2,680
	76 (24.4)	SHC	5,330	5,290	5,200	5,150	4,560	3,550
	80 (26.7)	SHC	6,250	6,200	6,110	6,060	5,470	4,460
	84 (28.9)	SHC	7,120	7,070	6,980	6,930	6,340	5,330
	88 (31.1)	SHC	7,980	7,940	7,850	7,800	7,210	6,200
75 (23.9)		TC	12,730	12,610	12,450	12,370	10,780	8,120
	76 (24.4)	SHC	4,050	4,010	3,960	3,920	3,370	2,450
	80 (26.7)	SHC	4,970	4,920	4,880	4,830	4,280	3,370
	84 (28.9)	SHC	5,840	5,790	5,740	5,700	5,150	4,240
	88 (31.1)	SHC	6,700	6,660	6,610	6,570	6,020	5,100

TC : Total Cooling Capacity (BTU/h) SHC : Sensible Heat Capacity (BTU/h)

NOTE

- Rating conditions (#) : Indoor Unit Entering Air Temp. 80 °F (26.7 °C) DB / 67 °F (19.4 °C) WB
: Outdoor Ambient Temp. 95 °F (35 °C) DB
- Above data does not take Freeze Prevention Protection during cooling operation into account.
For this reason, the value may vary from the actual cooling characteristics.
- Above data represents the value when the operation frequency of a compressor is fixed.

Indoor Unit : **CS-KE18NB4UW & CZ-18BT1U**

Outdoor Unit : **CU-KE18NKU**

Power Supply : 230V Single Phase 60Hz

< Cooling Capacity >

RATING CAPACITY:		17,500 BTU/h		AIR FLOW RATE:		341 CFM		
INDOOR		OUTDOOR						
ENT. TEMP. °F (°C)		AMBIENT TEMP. °F (°C)						
WB	DB		65 (18.3)	75 (23.9)	85 (29.4)	95 (35.0)	105 (40.6)	115 (46.1)
59 (15.0)		TC	12,260	12,550	12,830	13,060	13,460	9,520
	72 (22.2)	SHC	9,140	9,270	9,400	9,540	9,740	7,810
	76 (24.4)	SHC	10,330	10,470	10,600	10,730	10,930	9,010
	80 (26.7)	SHC	11,590	11,720	11,860	11,990	12,190	9,520
	84 (28.9)	SHC	12,260	12,550	12,830	13,060	13,380	9,520
	88 (31.1)	SHC	12,260	12,550	12,830	13,060	13,460	9,520
63 (17.2)		TC	18,110	17,790	17,400	17,000	14,080	9,650
	72 (22.2)	SHC	10,400	10,200	10,000	9,800	8,340	6,290
	76 (24.4)	SHC	11,590	11,390	11,190	11,000	9,540	7,480
	80 (26.7)	SHC	12,850	12,650	12,450	12,260	10,800	8,740
	84 (28.9)	SHC	14,040	13,850	13,650	13,450	11,990	9,650
	88 (31.1)	SHC	15,240	15,110	14,840	14,640	13,180	9,650
67 (19.4)		TC	18,510	18,220	17,860	# 17,500	14,220	9,750
	72 (22.2)	SHC	8,680	8,480	8,340	8,140	6,620	4,830
	76 (24.4)	SHC	9,870	9,740	9,540	9,340	7,880	6,020
	80 (26.7)	SHC	11,130	10,930	10,800	10,600	9,070	7,280
	84 (28.9)	SHC	12,320	12,190	11,990	11,790	10,330	8,480
	88 (31.1)	SHC	13,510	13,380	13,180	12,980	11,530	9,670
71 (21.7)		TC	18,820	18,570	18,260	17,940	14,290	9,810
	72 (22.2)	SHC	6,750	6,690	6,550	6,420	4,900	3,240
	76 (24.4)	SHC	7,950	7,880	7,750	7,610	6,090	4,430
	80 (26.7)	SHC	9,210	9,140	9,010	8,870	7,350	5,690
	84 (28.9)	SHC	10,470	10,330	10,200	10,070	8,540	6,890
	88 (31.1)	SHC	11,660	11,530	11,390	11,260	9,740	8,080
75 (23.9)		TC	19,010	18,800	18,530	18,260	14,280	9,810
	76 (24.4)	SHC	6,160	6,090	5,960	5,890	4,430	2,970
	80 (26.7)	SHC	7,420	7,350	7,220	7,150	5,690	4,230
	84 (28.9)	SHC	8,610	8,540	8,410	8,340	6,890	5,430
	88 (31.1)	SHC	9,800	9,740	9,670	9,540	8,080	6,620

TC : Total Cooling Capacity (BTU/h) SHC : Sensible Heat Capacity (BTU/h)

NOTE

1. Rating conditions (#) : Indoor Unit Entering Air Temp. 80 °F (26.7 °C) DB / 67 °F (19.4 °C) WB
: Outdoor Ambient Temp. 95 °F (35 °C) DB
2. Above data does not take Freeze Prevention Protection during cooling operation into account.
For this reason, the value may vary from the actual cooling characteristics.
3. Above data represents the value when the operation frequency of a compressor is fixed.

5-3. Cooling Capacity (Low Ambient)

Indoor Unit : **CS-KE12NB41 & CZ-18BT1U**

Outdoor Unit : **CU-KE12NK1**

Power Supply : 115V Single Phase 60Hz

< Cooling Capacity (Low Ambient) >

RATING CAPACITY:		11,900 BTU/h		AIR FLOW RATE:		235 CFM			
INDOOR		OUTDOOR							
ENT. TEMP. °F (°C)		AMBIENT TEMP. °F (°C)							
WB	DB		0 (-17.8)	5 (-15.0)	15 (-9.4)	25 (-3.9)	35 (1.7)	45 (7.2)	55 (12.8)
59 (15.0)		TC	9,530	9,550	9,560	9,590	9,600	9,590	9,570
	72 (22.2)	SHC	6,930	6,930	6,980	8,580	6,980	6,980	6,980
	76 (24.4)	SHC	7,800	7,800	7,850	9,450	7,850	7,850	7,850
	80 (26.7)	SHC	8,720	8,720	8,720	9,590	8,760	8,760	8,760
	84 (28.9)	SHC	9,530	9,550	9,560	9,590	9,600	9,590	9,570
	88 (31.1)	SHC	9,530	9,550	9,560	9,590	9,600	9,590	9,570
63 (17.2)		TC	9,440	9,460	9,530	9,590	9,650	9,660	9,670
	72 (22.2)	SHC	5,650	5,650	5,700	8,580	5,740	5,740	5,790
	76 (24.4)	SHC	6,520	6,520	6,570	9,450	6,610	6,610	6,660
	80 (26.7)	SHC	7,440	7,440	7,480	9,590	7,530	7,530	7,530
	84 (28.9)	SHC	8,300	8,300	8,350	9,590	8,400	8,400	8,400
	88 (31.1)	SHC	9,170	9,170	9,220	9,590	9,270	9,270	9,270
67 (19.4)		TC	9,250	9,290	9,410	9,530	9,620	9,670	9,720
	72 (22.2)	SHC	4,370	4,370	4,420	8,580	4,510	4,560	4,560
	76 (24.4)	SHC	5,240	5,240	5,290	9,450	5,380	5,420	5,420
	80 (26.7)	SHC	6,160	6,160	6,200	9,530	6,290	6,340	6,340
	84 (28.9)	SHC	7,020	7,020	7,070	9,530	7,160	7,210	7,210
	88 (31.1)	SHC	7,890	7,890	7,940	9,530	8,030	8,080	8,080
71 (21.7)		TC	8,950	9,010	9,210	9,380	9,520	9,610	9,710
	72 (22.2)	SHC	3,000	3,050	3,090	8,580	3,230	3,280	3,280
	76 (24.4)	SHC	3,870	3,920	3,960	9,380	4,100	4,140	4,140
	80 (26.7)	SHC	4,780	4,830	4,880	9,380	5,010	5,060	5,060
	84 (28.9)	SHC	5,650	5,700	5,740	9,380	5,880	5,930	5,930
	88 (31.1)	SHC	6,520	6,570	6,610	9,380	6,750	6,800	6,800
75 (23.9)		TC	8,590	8,650	8,930	9,160	9,360	9,480	9,620
	76 (24.4)	SHC	2,590	2,640	2,730	9,160	2,860	2,910	2,960
	80 (26.7)	SHC	3,500	3,550	3,640	9,160	3,780	3,820	3,870
	84 (28.9)	SHC	4,370	4,420	4,510	9,160	4,650	4,690	4,740
	88 (31.1)	SHC	5,240	5,290	5,380	9,160	5,520	5,560	5,610

TC : Total Cooling Capacity (BTU/h) SHC : Sensible Heat Capacity (BTU/h)

NOTE

1. Above data does not take Freeze Prevention Protection during cooling operation into account. For this reason, the value may vary from the actual cooling characteristics.
2. Above data represents the value when the operation frequency of a compressor is fixed.

Indoor Unit : **CS-KE18NB4UW & CZ-18BT1U**

Outdoor Unit : **CU-KE18NKU**

Power Supply : 230V Single Phase 60Hz

< Cooling Capacity (Low Ambient) >

RATING CAPACITY:		17,500 BTU/h		AIR FLOW RATE:		341 CFM			
INDOOR		OUTDOOR							
ENT. TEMP. °F (°C)		AMBIENT TEMP. °F (°C)							
WB	DB		0 (-17.8)	5 (-15.0)	15 (-9.4)	25 (-3.9)	35 (1.7)	45 (7.2)	55 (12.8)
59 (15.0)		TC	13,400	13,430	13,440	13,470	13,500	13,520	13,510
	72 (22.2)	SHC	9,740	9,740	9,740	11,860	9,740	9,800	9,800
	76 (24.4)	SHC	10,930	10,930	10,930	13,050	11,000	11,000	11,000
	80 (26.7)	SHC	12,190	12,190	12,190	13,470	12,190	12,260	12,190
	84 (28.9)	SHC	13,380	13,380	13,380	13,470	13,380	13,450	13,450
	88 (31.1)	SHC	13,400	13,430	13,440	13,470	13,500	13,520	13,510
63 (17.2)		TC	13,260	13,300	13,370	13,480	13,560	13,640	13,670
	72 (22.2)	SHC	7,950	7,950	7,950	11,860	8,080	8,080	8,140
	76 (24.4)	SHC	9,140	9,140	9,210	13,050	9,270	9,270	9,340
	80 (26.7)	SHC	10,400	10,400	10,400	13,480	10,530	10,530	10,600
	84 (28.9)	SHC	11,590	11,590	11,590	13,480	11,720	11,720	11,790
	88 (31.1)	SHC	12,790	12,790	12,850	13,480	12,920	12,980	12,980
67 (19.4)		TC	12,980	13,040	13,170	13,380	13,530	13,670	13,760
	72 (22.2)	SHC	6,090	6,160	6,220	11,860	6,360	6,420	6,420
	76 (24.4)	SHC	7,280	7,350	7,420	13,050	7,550	7,610	7,680
	80 (26.7)	SHC	8,540	8,610	8,680	13,380	8,810	8,870	8,870
	84 (28.9)	SHC	9,740	9,800	9,870	13,380	10,000	10,070	10,070
	88 (31.1)	SHC	11,000	11,000	11,060	13,380	11,190	11,260	11,330
71 (21.7)		TC	12,550	12,630	12,830	13,160	13,390	13,600	13,750
	72 (22.2)	SHC	4,230	4,230	4,370	11,860	4,570	4,630	4,700
	76 (24.4)	SHC	5,430	5,490	5,560	13,050	5,760	5,820	5,890
	80 (26.7)	SHC	6,690	6,690	6,820	13,160	7,020	7,080	7,150
	84 (28.9)	SHC	7,880	7,950	8,010	13,160	8,210	8,280	8,340
	88 (31.1)	SHC	9,070	9,140	9,210	13,160	9,400	9,470	9,540
75 (23.9)		TC	12,010	12,110	12,380	12,850	13,150	13,440	13,650
	76 (24.4)	SHC	3,640	3,700	3,770	12,850	4,030	4,170	4,230
	80 (26.7)	SHC	4,900	4,960	5,030	12,850	5,290	5,360	5,490
	84 (28.9)	SHC	6,090	6,160	6,220	12,850	6,490	6,620	6,690
	88 (31.1)	SHC	7,280	7,350	7,420	12,850	7,680	7,810	7,880

TC : Total Cooling Capacity (BTU/h) SHC : Sensible Heat Capacity (BTU/h)

NOTE

1. Above data does not take Freeze Prevention Protection during cooling operation into account. For this reason, the value may vary from the actual cooling characteristics.
2. Above data represents the value when the operation frequency of a compressor is fixed.

5-4. Heating Capacity

Indoor Unit : **CS-KE12NB41 & CZ-18BT1U**

Outdoor Unit : **CU-KE12NK1**

Power Supply : 115V Single Phase 60Hz

< Heating Capacity >

RATING CAPACITY:		13,600 BTU/h		AIR FLOW RATE:		268 CFM	
OUTDOOR		INDOOR					
ENT. TEMP. °F (°C)		AMBIENT TEMP. °F (°C)					
WB		60 (15.6)	65 (18.3)	70 (21.1)	75 (23.9)	80 (26.7)	
0 (-17.8)	TH	7,510	7,540	7,560	7,580	7,590	
3 (-16.1)	TH	7,760	7,790	7,810	7,830	7,840	
8 (-13.3)	TH	8,350	8,380	8,410	8,420	8,440	
13 (-10.6)	TH	8,980	9,000	9,030	9,050	9,060	
18 (-7.8)	TH	9,660	9,690	9,720	9,730	9,750	
23 (-5.0)	TH	10,390	10,420	10,440	10,460	10,470	
28 (-2.2)	TH	11,150	11,180	11,200	11,210	11,220	
33 (0.6)	TH	11,930	11,960	11,980	12,000	11,740	
38 (3.3)	TH	12,720	12,750	12,770	12,780	11,740	
43 (6.1)	TH	13,560	13,580	# 13,600	13,010	11,740	
48 (8.9)	TH	14,420	14,440	14,120	13,010	11,740	
53 (11.7)	TH	15,290	15,020	14,200	13,010	11,740	
58 (14.4)	TH	15,990	15,080	14,240	13,010	11,740	
63 (17.2)	TH	16,000	15,070	14,220	13,010	11,740	
65 (18.3)	TH	15,980	15,050	14,190	13,010	11,740	

TH : Total Heating Capacity (BTU/h)

NOTE

- Rating conditions (#) : Indoor Unit Entering Air Temp. 70 °F (21.1 °C) DB
: Outdoor Ambient Temp. 47 °F (8.3 °C) DB / 43 °F (6.1 °C) WB
- Above data does not take Defrost Operation, Overload Prevention Protection, and/or Cold Air Prevention Protection during heating operation into account. For this reason, the value may vary from the actual heating characteristics.
- Above data represents the value when the operation frequency of a compressor is fixed.

Indoor Unit : **CS-KE18NB4UW & CZ-18BT1U**

Outdoor Unit : **CU-KE18NKU**

Power Supply : 230V Single Phase 60Hz

< Heating Capacity >

RATING CAPACITY:		20,400 BTU/h		AIR FLOW RATE:		383 CFM	
OUTDOOR		INDOOR					
ENT. TEMP. °F (°C)		AMBIENT TEMP. °F (°C)					
WB		60 (15.6)	65 (18.3)	70 (21.1)	75 (23.9)	80 (26.7)	
0 (-17.8)	TH	11,350	11,400	11,440	11,480	11,510	
3 (-16.1)	TH	11,720	11,770	11,820	11,850	11,890	
8 (-13.3)	TH	12,600	12,650	12,700	12,750	12,780	
13 (-10.6)	TH	13,520	13,580	13,630	13,670	13,710	
18 (-7.8)	TH	14,540	14,600	14,650	14,700	14,730	
23 (-5.0)	TH	15,610	15,670	15,730	15,770	15,810	
28 (-2.2)	TH	16,730	16,800	16,850	16,890	16,770	
33 (0.6)	TH	17,900	17,960	18,010	18,060	16,770	
38 (3.3)	TH	19,050	19,120	19,170	18,590	16,770	
43 (6.1)	TH	20,290	20,350	# 20,400	18,590	16,770	
48 (8.9)	TH	21,550	21,610	20,410	18,590	16,770	
53 (11.7)	TH	22,830	22,230	20,410	18,590	16,770	
58 (14.4)	TH	23,990	22,230	20,410	18,590	16,770	
63 (17.2)	TH	23,990	22,230	20,410	18,590	16,770	
65 (18.3)	TH	23,990	22,230	20,410	18,590	16,770	

TH : Total Heating Capacity (BTU/h)

NOTE

1. Rating conditions (#) : Indoor Unit Entering Air Temp. 70 °F (21.1 °C) DB
: Outdoor Ambient Temp. 47 °F (8.3 °C) DB / 43 °F (6.1 °C) WB
2. Above data does not take Defrost Operation, Overload Prevention Protection, and/or Cold Air Prevention Protection during heating operation into account. For this reason, the value may vary from the actual heating characteristics.
3. Above data represents the value when the operation frequency of a compressor is fixed.

6. ELECTRICAL DATA

6-1. Electrical Characteristics

Indoor Unit **CS-KE12NB41 & CZ-18BT1U**

Outdoor Unit **CU-KE12NK1**

Cooling

			Indoor Unit	Outdoor Unit	Complete Unit
			Fan Motor	Fan Motor + Compressor	
Performance at			115V Single-phase 60Hz		
Rating conditions	Running amp.	A	0.21	12.39	12.6
	Power input	W	18	1,242	1,260

Rating conditions: Indoor air temperature: 80 °F (26.7 °C) DB / 67 °F (19.4 °C) WB
 Outdoor air temperature: 95 °F (35 °C) DB

Heating

			Indoor Unit	Outdoor Unit	Complete Unit
			Fan Motor	Fan Motor + Compressor	
Performance at			115V Single-phase 60Hz		
Rating conditions	Running amp.	A	0.25	14.35	14.6
	Power input	W	20	1,440	1,460

Rating conditions: Indoor air temperature 70 °F (21.1 °C) DB
 Outdoor air temperature 47 °F (8.3 °C) DB / 43 °F (6.1 °C) WB

Indoor Unit **CZ-KE18NB4U & CZ-18BT1U**

Outdoor Unit **CU-KE18NKU**

(1) Voltage:230V

Cooling

< 230V >

			Indoor Unit	Outdoor Unit	Complete Unit
			Fan Motor	Fan Motor + Compressor	
Performance at			230V Single-phase 60Hz		
Rating conditions	Running amp.	A	0.15	8.15	8.3
	Power input	W	22	1,838	1,860

Rating conditions: Indoor air temperature: 80 °F (26.7 °C) DB / 67 °F (19.4 °C) WB
 Outdoor air temperature: 95 °F (35 °C) DB

Heating

			Indoor Unit	Outdoor Unit	Complete Unit
			Fan Motor	Fan Motor + Compressor	
Performance at			230V Single-phase 60Hz		
Rating conditions	Running amp.	A	0.19	10.31	10.5
	Power input	W	27	2,313	2,340

Rating conditions: Indoor air temperature 70 °F (21.1 °C) DB
 Outdoor air temperature 47 °F (8.3 °C) DB / 43 °F (6.1 °C) WB

(2) Voltage:208V

Cooling

< 208V >

			Indoor Unit	Outdoor Unit	Complete Unit
			Fan Motor	Fan Motor + Compressor	
Performance at			208V Single-phase 60Hz		
Rating conditions	Running amp.	A	0.16	8.94	9.1
	Power input	W	22	1,838	1,860

Rating conditions: Indoor air temperature: 80 °F (26.7 °C) DB / 67 °F (19.4 °C) WB
 Outdoor air temperature: 95 °F (35 °C) DB

Heating

			Indoor Unit	Outdoor Unit	Complete Unit
			Fan Motor	Fan Motor + Compressor	
Performance at			208V Single-phase 60Hz		
Rating conditions	Running amp.	A	0.2	11.3	11.5
	Power input	W	27	2,313	2,340

Rating conditions: Indoor air temperature 70 °F (21.1 °C) DB
 Outdoor air temperature 47 °F (8.3 °C) DB / 43 °F (6.1 °C) WB

6-2. Electric Wiring Diagrams

Indoor Unit **CS-KE12NB41 & CZ-18BT1U**
CS-KE18NB4UW & CZ-18BT1U

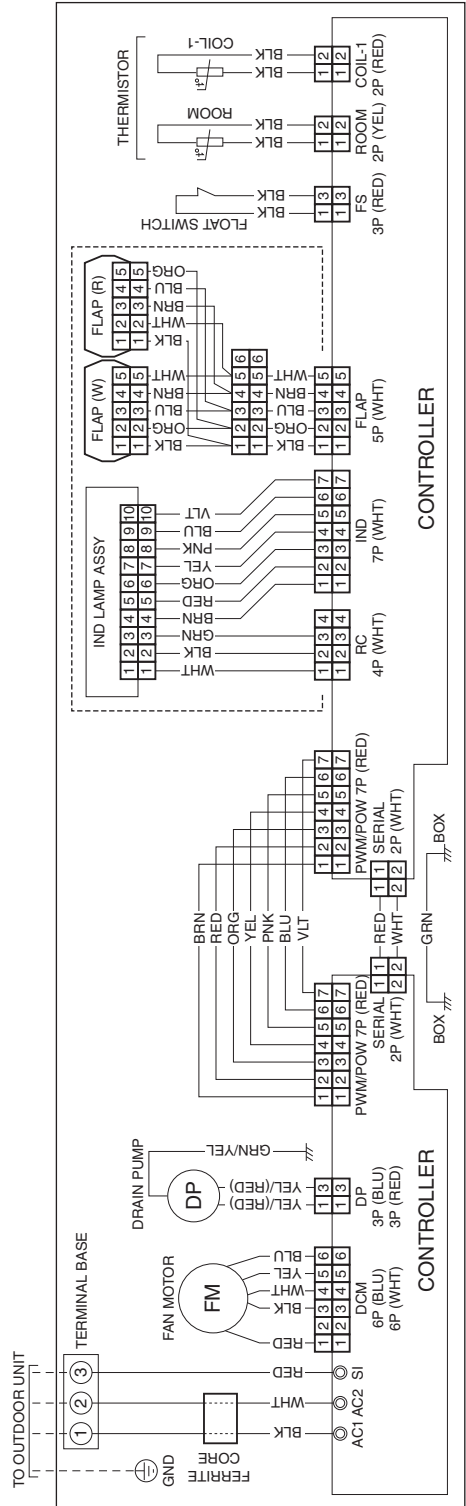

8FA2-5250-46900-2

Outdoor Unit **CU-KE12NK1**

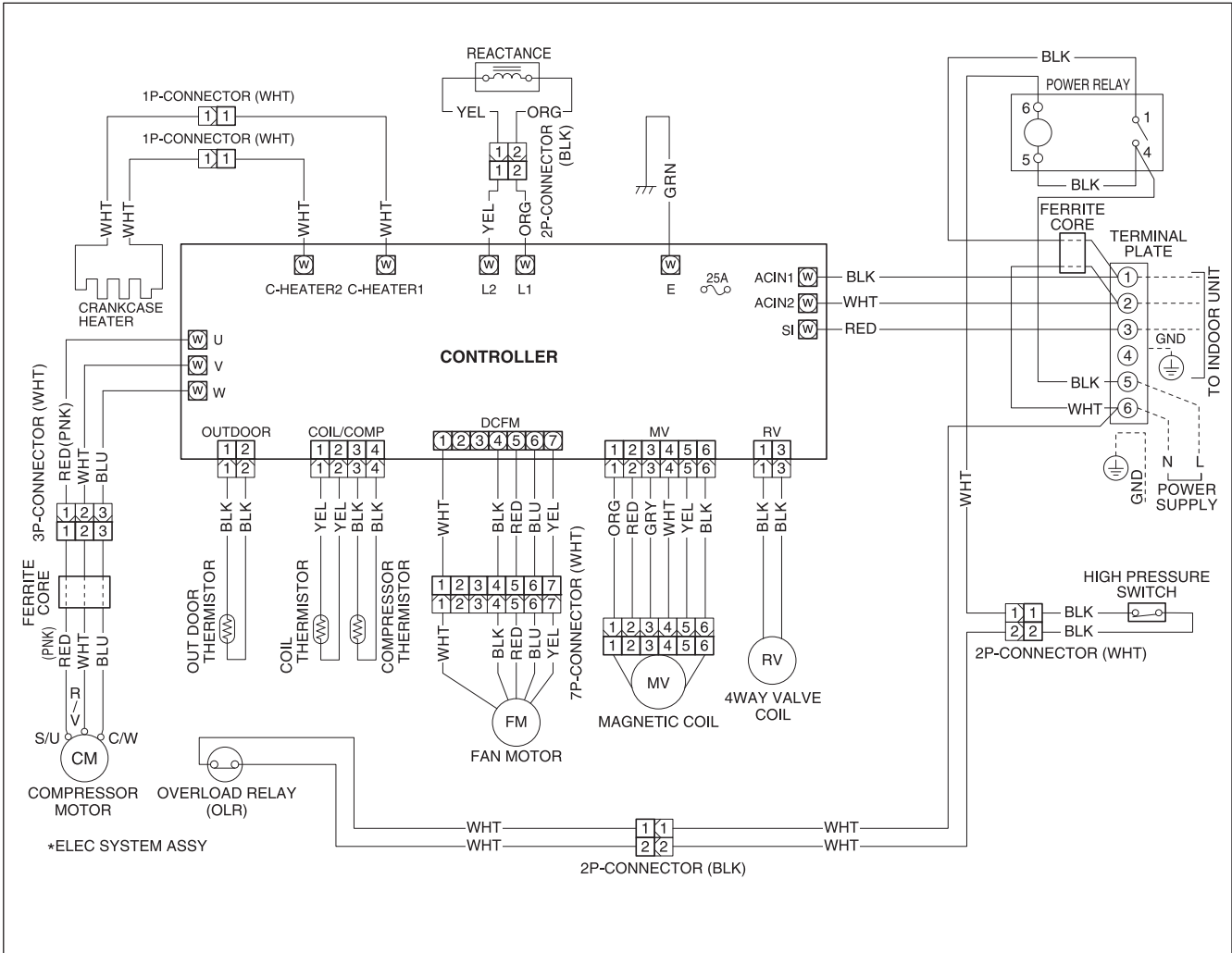

8FA2-5251-12200-2

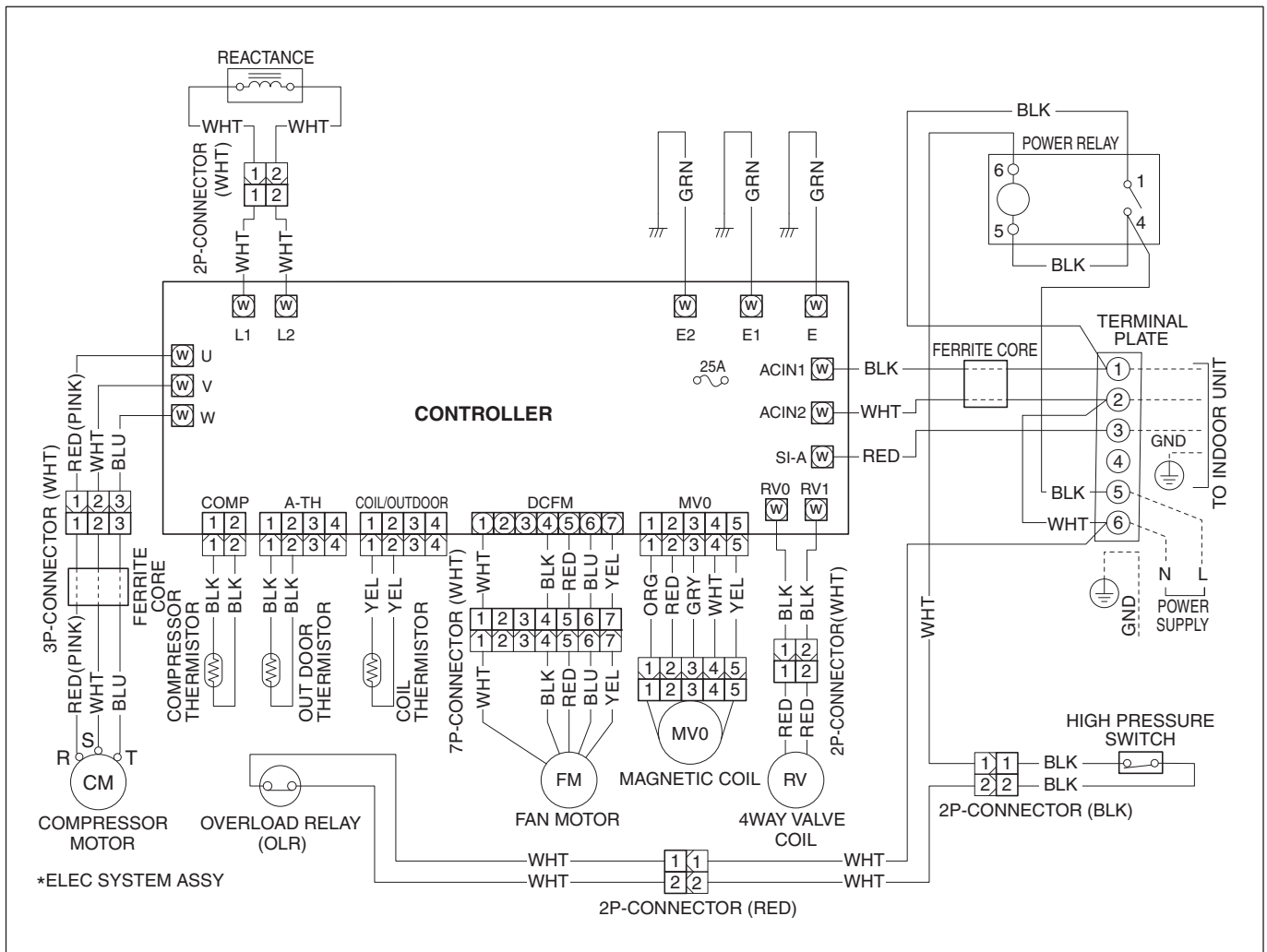

8FA2-5251-11900-2

7. MAINTENANCE

7-1. Address Setting of the Remote Controller

The address can be set in order to prevent interference between remote controllers when two indoor units are installed near each other. The address is normally set to "A." To set a different address, it is necessary to change the address on the second remote controller.

NOTE

Once changed, you cannot restore the original address setting of the air conditioner.

- (1) Switch on the power source.
- (2) Break the address-setting tab marked "A" on the second remote controller to change the address (Fig. 1). When the tab is removed, the address is automatically set to B (Fig. 2).
- (3) Press and hold the remote controller HIGH POWER button and 1 HR TIMER button. Then, press and hold the ACL (reset) button with a pointed object such as the tip of a pen. After 5 seconds, release ACL button first, then release HIGH POWER and 1 HR. TIMER buttons, "oP-1" (test run) appears, blinking in the remote controller clock display area.
- (4) Each time the 1 HR TIMER button is pressed, the display changes as shown below. Press this button 2 times to change the display to "oP-7" (address setting). (Fig. 3)

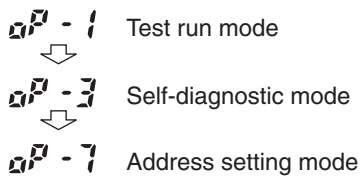

- (5) "oP-7" has now been selected for address setting.
- (6) Press the ON/OFF operation button on the remote controller. (Fig. 3) Check that the "beep" signal received sound is heard from the second indoor unit (approximately 5 times). The sound you hear is the signal that the remote controller address has been changed.
- (7) Finally press the remote controller ACL (reset) button to cancel the blinking "oP-7" display. (Fig. 3)

Changing of the second remote controller address is now completed.

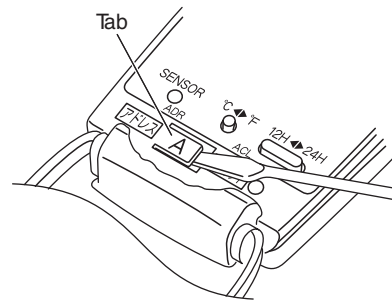

Fig. 1

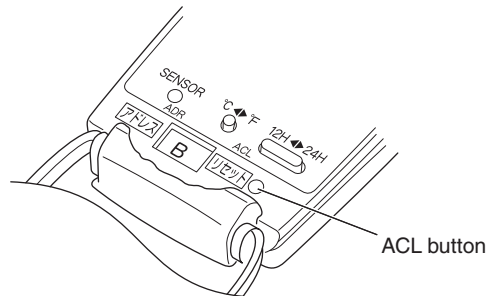

Fig. 2

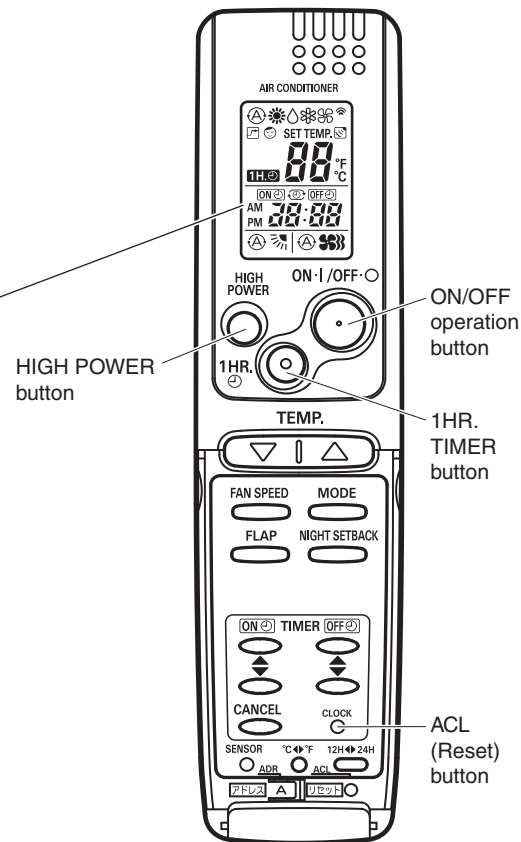
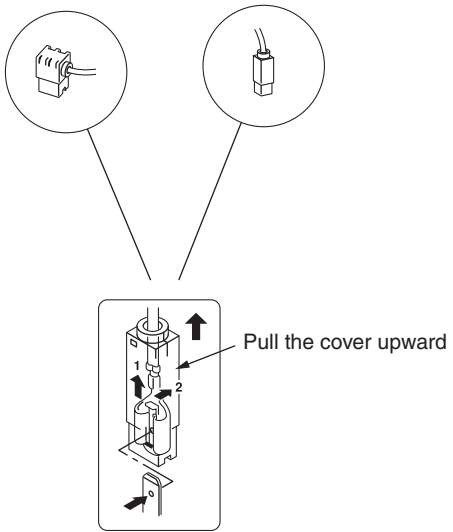

Fig. 3

7-2. Disconnecting and Connecting Positive Connector for Outdoor Unit



When the cover is pulled upward, the lock is released with the sequence of 1 and 2.

One of the two types of connectors illustrated at left is used. Their basic structure is the same for each.

How to Disconnect

Hold the resin connector cover, and pull the connector off. You cannot disconnect the connector by pulling the wire since it is locked inside. Always hold the cover to disconnect. (See illustration at left.) For the connector without the resin cover, push the lock in the direction of "2" while pulling it off.

How to Connect

In order to connect, hold the resin cover of the connector and push it in. Confirm the click sound for the inside lock.

7-3. Disassembly Procedure



WARNING

- To avoid electrical shock hazard, be sure to disconnect power before attempting to disassemble the unit.
- When a footstool, etc. is used for disassembling the indoor unit, be careful not to fall down. If you fall down, you might be injured seriously.

7-3-1. Remove the air intake grill.

- (1) Slide the 2 latches each to the corresponding arrow direction. (Fig. 1 and Fig. 2)
Open downward the air intake grill located on the latch side.
- (2) Undo the air intake grill drop preventive hook. (Fig. 3)
Undo the 2 hinges for the grill and remove the air intake grill.

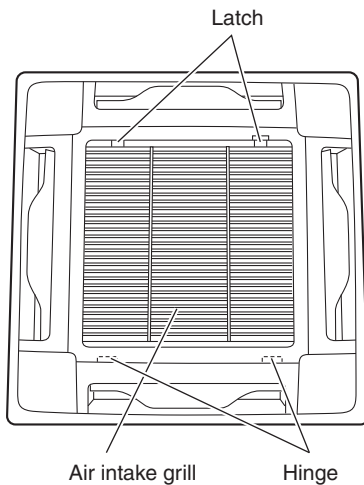

Fig.1

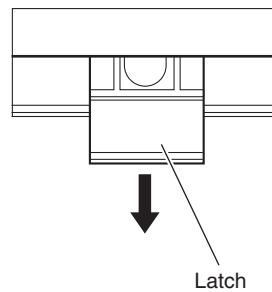

Fig.2

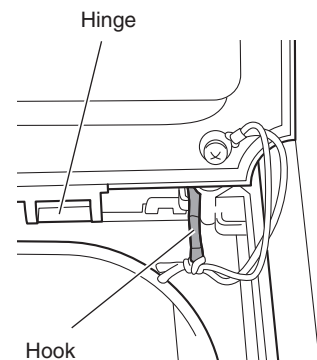

Fig.3

7-3-2. Disconnect the connectors in the control box.

- (1) Remove the 2 screws and remove the control box cover. (Fig. 4)
- (2) Disconnect the connectors CN04 (FLAP 5P), CN12 (RC 4P) and CN13 (IND 7P). (Fig. 5)

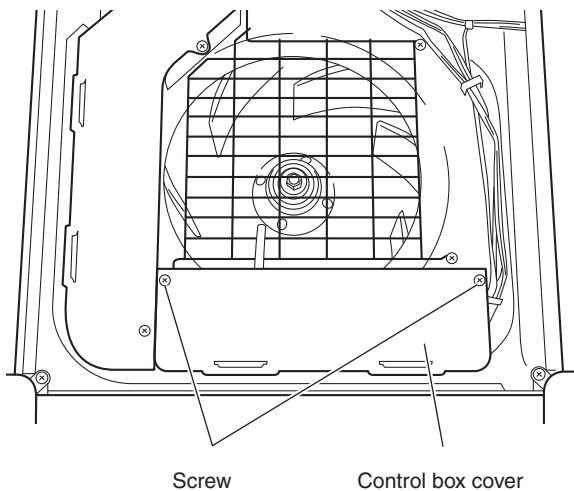

Fig.4

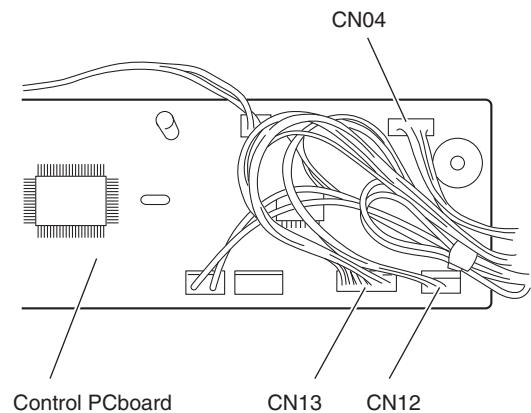

Fig.5

7-3-3. Remove the ceiling panel.

- (1) Open the clamp (4 locations) and remove the 2 lead wires from the clamps. (Fig. 6)
- (2) Remove the 4 screws fixing the corner cover (at 3 locations) and indicator cover (at 1 location). (Fig. 6)
- (3) Press the center 1 of the cover and remove the cover with the section 2 pulled down. (Fig. 7)
- (4) Remove the strap (3 locations) from the hook on the ceiling panel. (Fig. 8)

NOTE There is no strap on the indicator cover.

- (5) Remove the bolt (4 locations) with a washer and remove the ceiling panel. (Fig. 9)

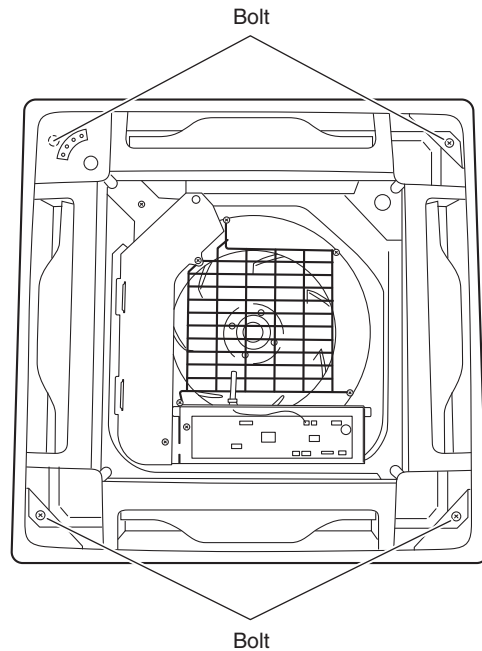
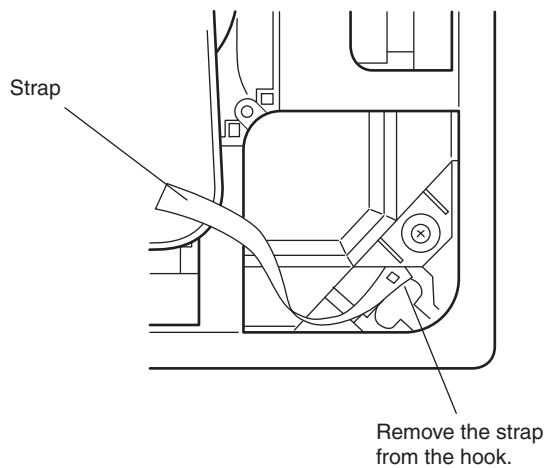
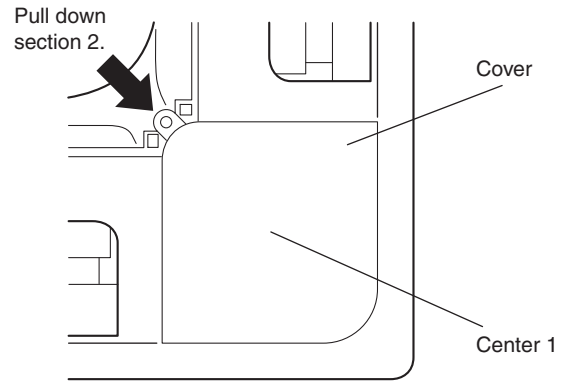
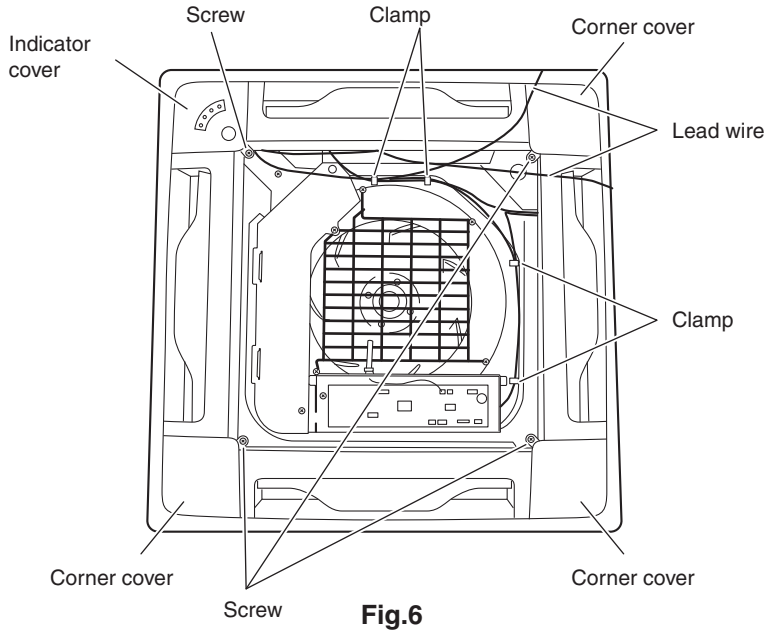

7-3-4. Remove the indoor air temperature sensor.

- (1) Disconnect the connector CN08 (ROOM 2P) in the control box and remove the indoor air temperature sensor. (Fig. 10)

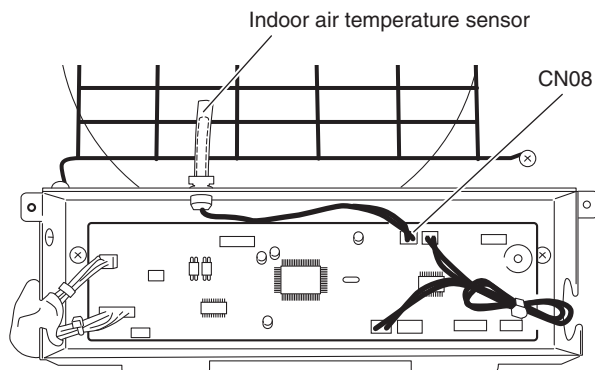

Fig.10

7-3-5. Remove the power box and control box.

- (1) Remove a screw and remove the terminal cover. (Fig. 11)
- (2) Remove the 2 screws and remove the power box cover. (Fig. 11)
- (3) Disconnect the power lines (No. 1 and No. 2) / signal line (No. 3) and ground cable from the terminals in the power box. (Fig. 12)

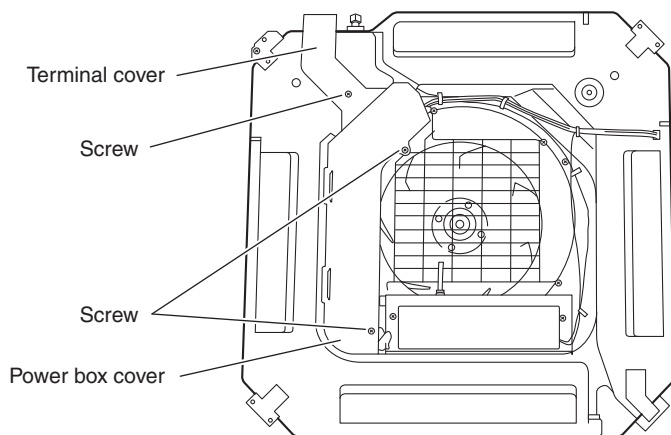

Fig.11

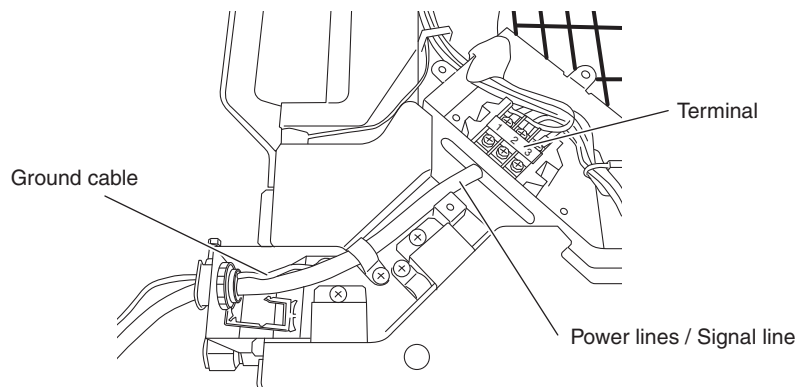

Fig.12

- (4) Disconnect the connector CN07 (DP 2P) in the power box. (Fig. 13)
Remove a screw and disconnect the ground cable. (Fig. 13)
- (5) Disconnect the connector CN03 (DCM 6P) in the power box. (Fig. 14)
- (6) Remove the 4 screws and remove the power box. (Fig. 14)
- (7) Disconnect the connectors CN06 (FS 3P) and CN09 (COIL-1 2P) in the control box. (Fig. 15)
- (8) Remove the 2 screws and remove the control box. (Fig. 15)

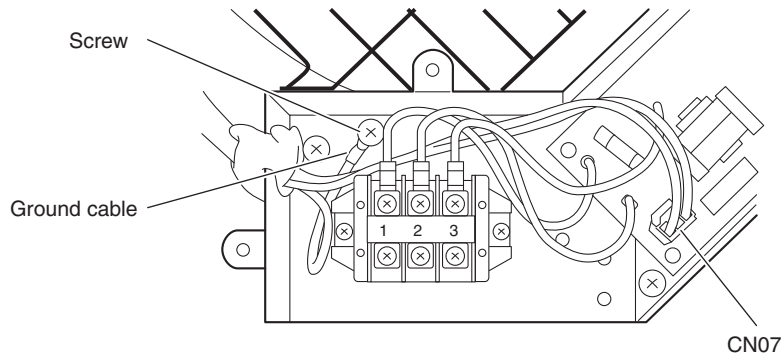

Fig.13

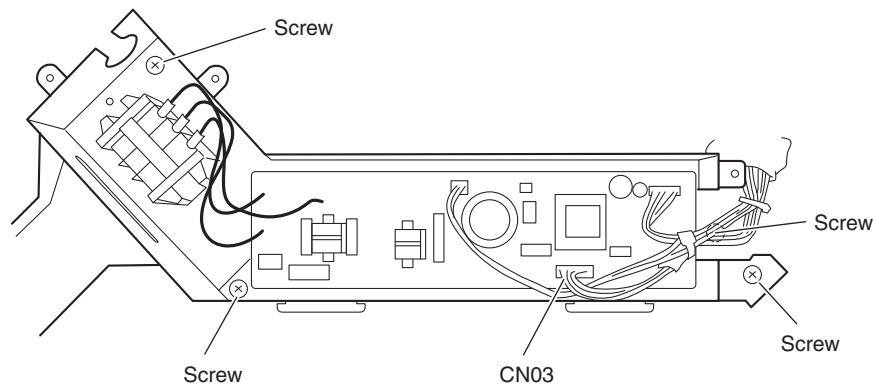

Fig.14

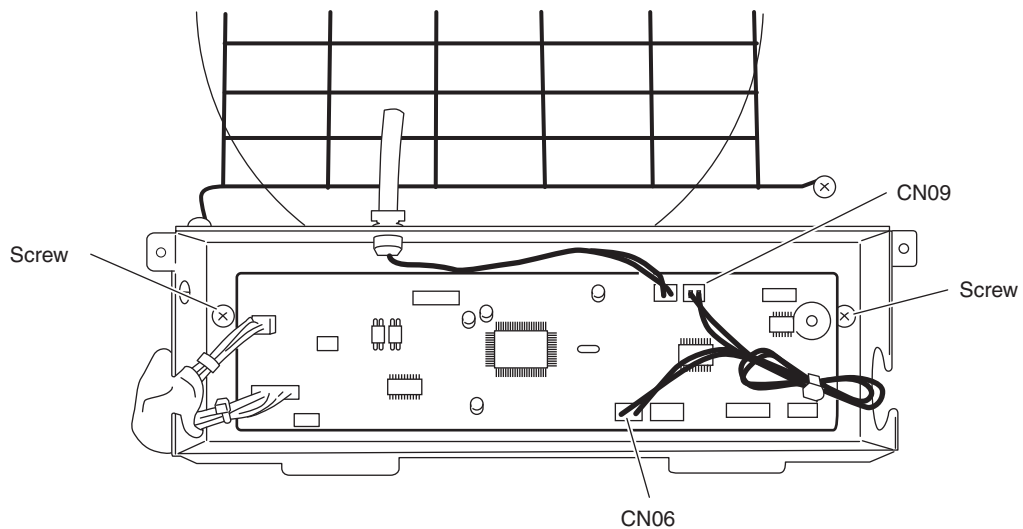

Fig.15

NOTE For the removal of the following components, perform any work after removing the indoor unit (main body) from the ceiling.

- Main body lower section
- Heat exchanger sensor
- Drain pump
- Float switch
- Turbo fan
- Fan motor
- Heat exchanger

1. Perform the work after draining the water to prevent the water leakage from the drain pan.
 - Put a bucket, etc., under the drain cap and remove the drain cap to drain the water.
(Fig. 16)
2. Refer to the installation instructions for recovery of refrigerant or removal of the power cable or tubing.

7-3-6. Remove the main body lower section.

- (1) Remove the 4 screws. (Fig. 16)
- (2) Remove the 2 screws. (Fig. 17)
- (3) Disconnect the connector CN03 (DCM 6P) in the power box. (Fig. 18)
- (4) Lift the main body lower section and remove it from the main body upper section.

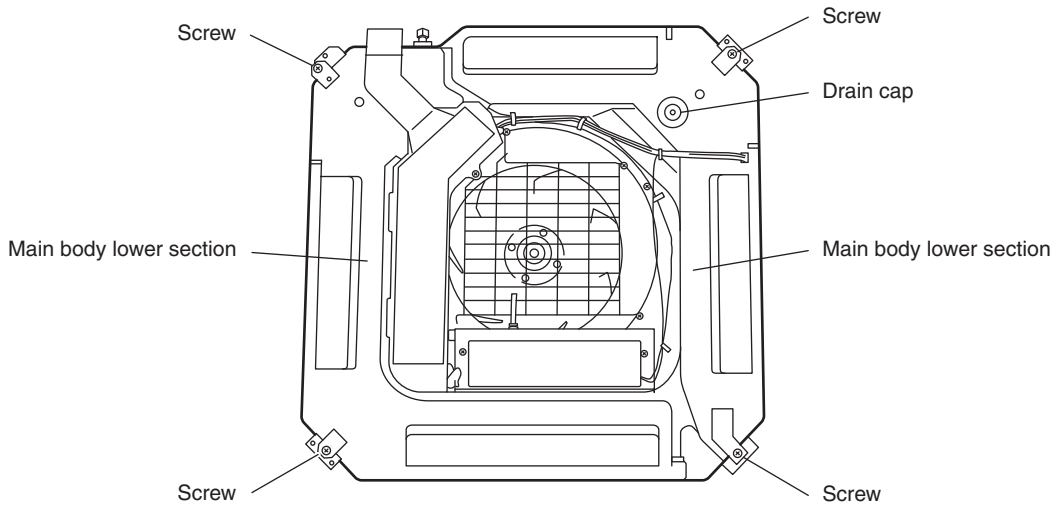

Fig.16

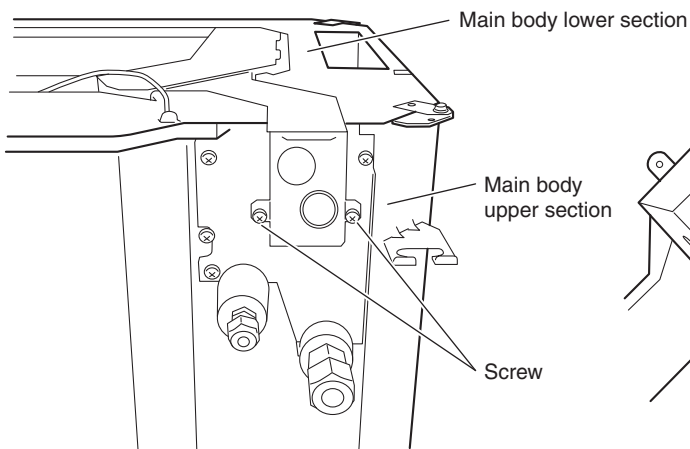

Fig.17

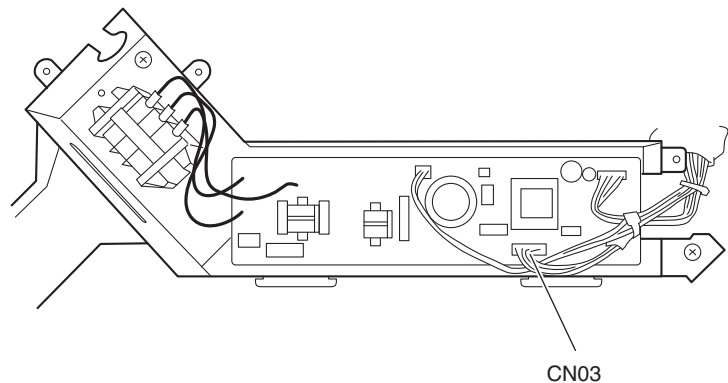

Fig.18

7-3-7. Remove the heat exchanger sensor.

- (1) Remove the heat exchanger sensor from the sensor holder. (Fig. 19)

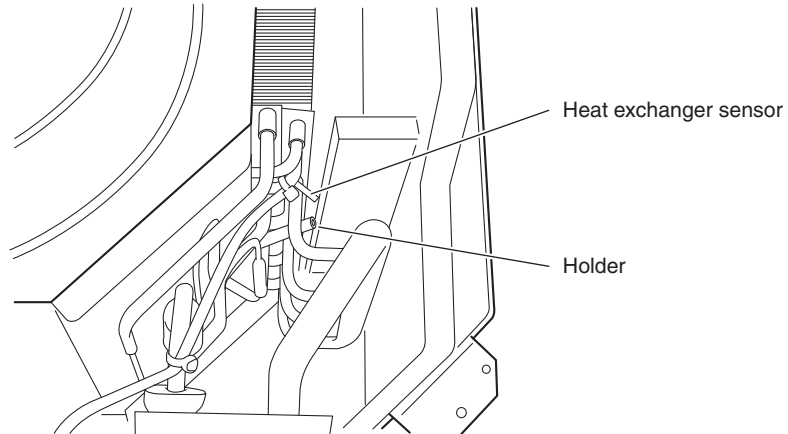

Fig.19

7-3-8. Remove the drain pump and float switch.

- (1) Remove the 2 screws (Fig. 20)
- (2) Loosen the clamp and disconnect the drain hose from the drain pump. (Fig. 20)
- (3) Remove the drain pump from the main body upper section. (Fig. 20)
- (4) Remove a nut and remove the float switch. (Fig. 21)

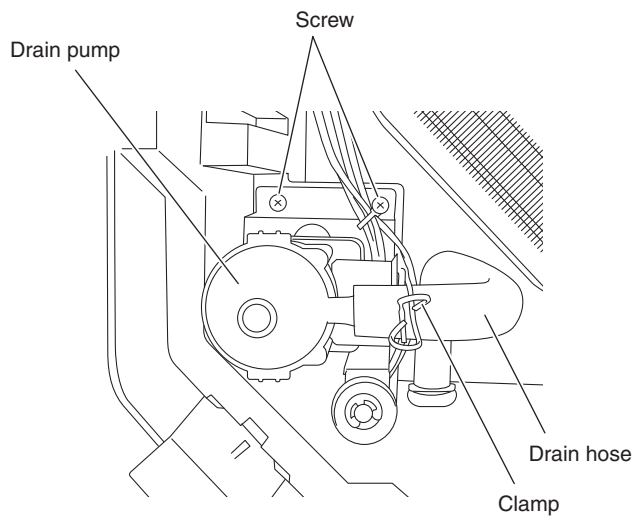

Fig.20

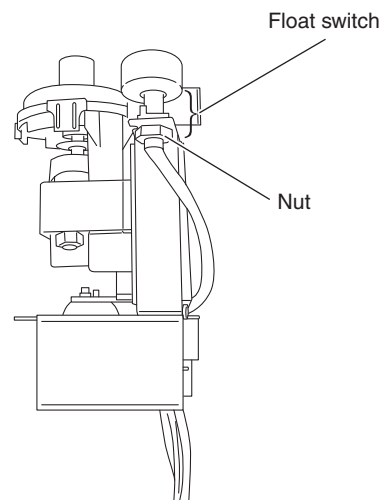

Fig.21

7-3-9. Remove the turbo fan and fan motor.

- (1) Remove a nut and remove the turbo fan. (Fig. 22)
- (2) Remove the 2 screws and 3 nuts, and remove the fan motor. (Fig. 23)

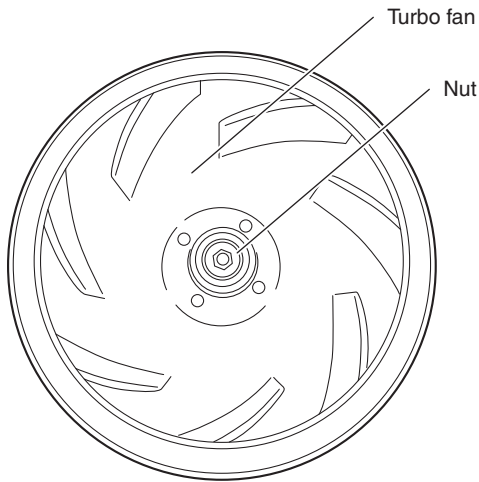

Fig.22

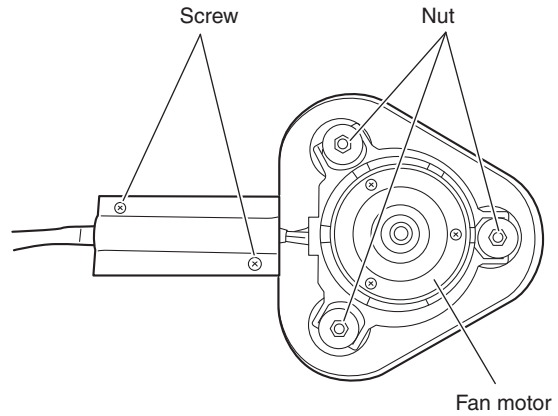

Fig.23

7-3-10. Remove the heat exchanger.

- (1) Remove the 3 screws. (Fig. 24)
- (2) Remove the 3 screws. (Fig. 25)
- (3) Remove the heat exchanger from the main body upper section with the heat exchanger lifted.

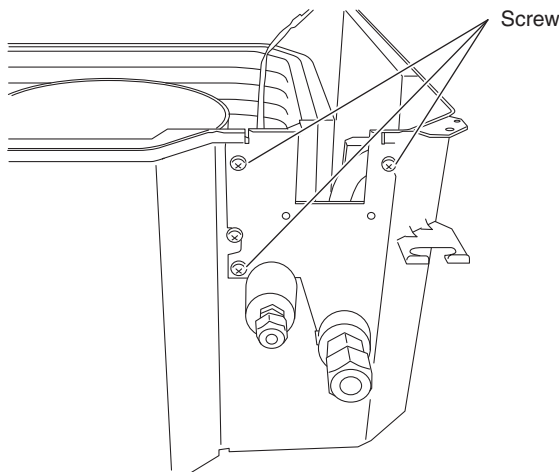

Fig.24

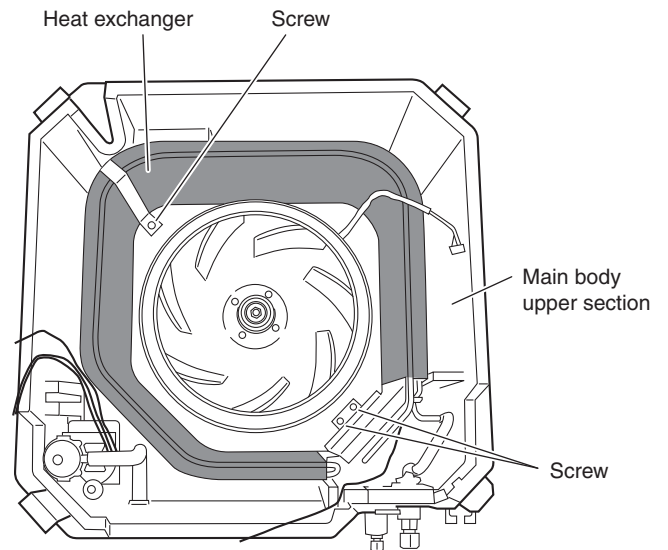

Fig.25

8. FUNCTIONS

8-1. Operation Functions

■ Emergency operation

Emergency operation is available when the remote controller malfunctions, has been lost, or otherwise cannot be used.

To operate the system, press the OPERATION button, which is also used as the receiver, below the unit display. Each time this button is pressed, the OPERATION lamp changes color to indicate the type of operation. Select the desired type of operation.



- The set temperature is 4°F(2°C) below the detected room temperature in the case of cooling operation, and 4°F(2°C) above the room temperature in the case of heating operation. The flap and fan speed settings are AUTO.

■ AUTO cooling/heating operation

● Selecting the operation mode

- When AUTO mode is selected, the microprocessor calculates the difference between the set temperature and the room temperature, and automatically switches to Cooling or Heating mode.

Room temp. \geq Set temp. \rightarrow COOL
 Room temp. $<$ Set temp. \rightarrow HEAT

- As shown by the example in the figure below, with AUTO cooling/heating operation, the mode changes between Heating and Cooling mode according to changes in the relationship between the current room temperature and the set temperature.

Example

Example of operation in AUTO mode with the set room temperature at 74°F(23°C).

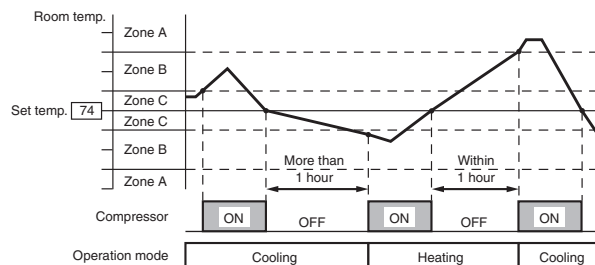

■ SENSOR DRY

During DRY operation, the system adjusts the room temperature and fan speed according to the conditions in the room, in order to maintain a comfortable room environment.

SENSOR DRY operation

- DRY operation is as shown in the figure below.

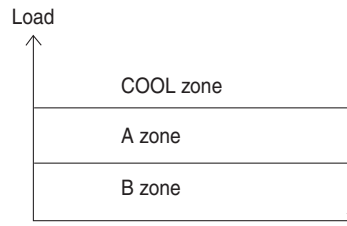

Conditions are monitored at all times when the room temperature is below 59°F(15°C).

DRY A

The compressor operation frequency varies.
 The indoor fan operates with 1/f fluctuation.

DRY B

The compressor operates at a low operating frequency.
 The indoor fan operates with 1/f fluctuation.

Monitor

- Monitoring operation takes place when the room temperature is below 59°F(15°C), or more than 5°F(3°C) below the set temperature.
- When the monitoring range is entered, the compressor stops, and the indoor fan operates with 1/f fluctuation.

■ PAM- α control

- In order to further improve inverter performance, control is switched between PWM control at low operation speeds, and PAM control at high operation speeds, making the most effective use of power.

■ HIGH POWER

This function acts to raise the power but keeps the AC system in the same operating mode. This function is set with the HIGH POWER button on the remote controller.

(It can be set regardless of the temperature and fan speed settings.)

● HIGH POWER operation from remote controller

The unit operates at maximum output for 30 minutes, regardless of the desired temperature. The fan speed is 1 step above "High."

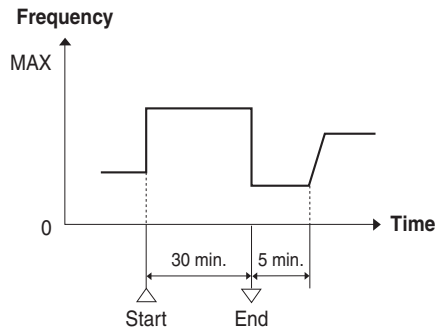

NOTE

- When HIGH POWER operation ends, the unit operates at low Hz for 5 minutes, regardless of the thermostat OFF conditions.
- When in DRY mode, operation is in the cooling zone.

■ Lamp colors

OPERATION lamp

HEAT operation	Red
DRY operation	Orange
COOL operation	Green
FAN operation	Green
DEFROSTING operation	Red and Orange alternately

OPERATION lamp

Green

TIMER lamp

Green

HIGH POWER lamp

Green

■ Timer backup

- Operation stops if there are no operator controls for 25 hours or longer after unit operation switched from OFF to ON by use of ON timer operation.

■ NIGHT SETBACK

- When NIGHT SETBACK operation is set, the temperature and fan speed settings will be adjusted automatically to allow comfortable sleep.
- When NIGHT SETBACK operation is set, "☺" mark appears on the remote controller. The main unit display lamp also becomes dimmer.

● COOL and DRY modes

When the night setback mode is selected, the air conditioner automatically raises the temperature setting $2^{\circ}\text{F}(1^{\circ}\text{C})$ when 30 minutes have passed after the selection was made, and then another $2^{\circ}\text{F}(1^{\circ}\text{C})$ after another 30 minutes have passed, regardless of the indoor temperature when night setback was selected. This enables you to save energy without sacrificing comfort. This function is convenient when gentle cooling is needed.

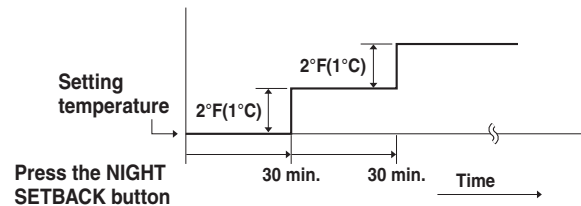

Press the NIGHT SETBACK button

● HEAT mode

When the night setback mode is selected, the air conditioner automatically lowers the temperature setting $4^{\circ}\text{F}(2^{\circ}\text{C})$ when 30 minutes have passed after the selection was made, and then another $4^{\circ}\text{F}(2^{\circ}\text{C})$ after another 30 minutes have passed, regardless of the indoor temperature when night setback was selected. This enables you to save energy without sacrificing comfort. This function is convenient when gentle heating is needed.

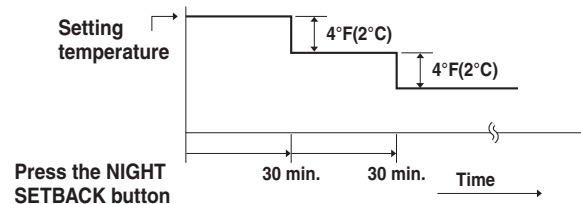

Press the NIGHT SETBACK button

8-2. Protective Functions

Overload prevention during heating

During HEAT operation, the temperature of the indoor heat exchanger is used to control the frequency and lessen the load on the compressor before the protective device is activated.

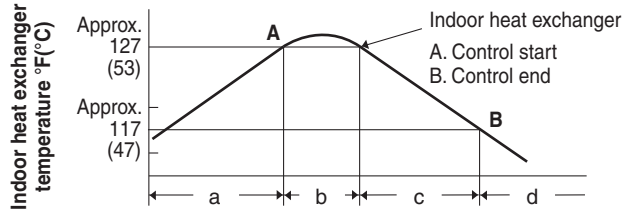

- Area: Automatic capacity control
- When Point A has been exceeded, the operation frequency is reduced by a certain proportion.
- Area: Frequency increase is prohibited.
- At Point B and below, overload prevention is ended and control is the same as in the a area.

Freeze prevention

During COOL or DRY operation, freezing is detected and operation is stopped when the temperature of the indoor heat exchanger matches the conditions below.

- Freeze-prevention operation is engaged when the temperature of the indoor heat exchanger is below 43°F(6°C).
- Restart after freeze-prevention operation occurs when the temperature of the indoor heat exchanger reaches 46°F(8°C) or above.

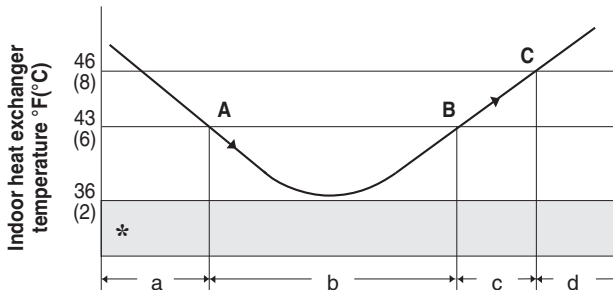

- Area: Automatic capacity control
 - When the temperature drops below Point A, the operation frequency is reduced by a certain proportion.
 - Area: Frequency increase is prohibited.
 - When the temperature reaches Point C or above, freezing prevention is ended and control is the same as in the a area.
- * When the temperature drops to below 36°F(2°C) (continuously for 2 minutes or longer), the compressor stops. Once the freeze condition is detected, the air conditioner will work less than the maximum frequency until it is turned off.

Cold-air prevention during heating

During heating, the fan speed is set to "LL" (very low) or stopped. As the temperature of the indoor heat exchanger rises, the fan speed is changed to the set speed.

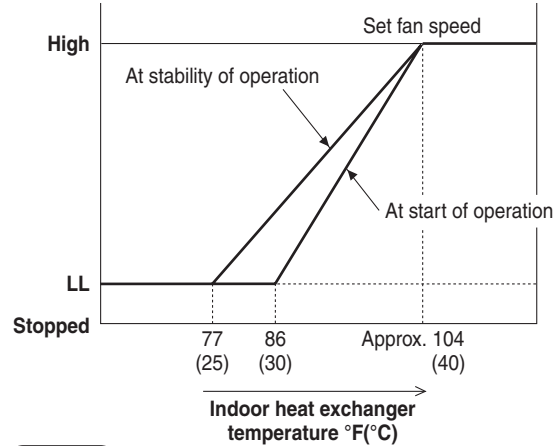

NOTE

- The fan speed is forcibly changed to "LL" beginning 30 seconds after the thermostat turns OFF.
- At stability of operation refers to operation when the room temperature has approached the set temperature.
- When HEAT operation starts, the indoor fan is stopped until the temperature of the indoor heat exchanger reaches 68°F(20°C) or higher, or until the room temperature reaches 59°F(15°C) or higher.

Compressor discharge temperature control

This function controls the operation frequency to prevent the compressor discharge temperature from rising more than a specified temperature.

Compressor discharge temperature °F(°C)

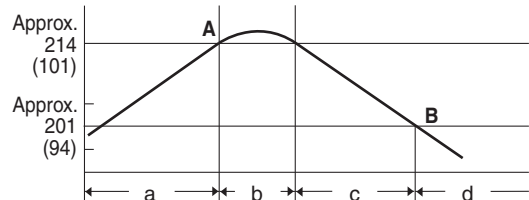

- Area: Automatic capacity control.
 - When the temperature rises above Point A, the operation frequency is reduced at a specified rate.
 - Area: Further frequency increase is prohibited.
 - When the temperature falls below Point B, prevention of a rise in frequency is released and the air conditioner operates as in a area.
- * The compressor will stop if the temperature of the compressor discharge exceeds 248°F(120°C) due to shortage of gas or other reason.

■ Defrost detection and release

● Reverse-Cycle Defrosting

Defrosting Sequence

Heating operation

- Outdoor fan ON
- 4-way valve ON

Frost sensing

Defrost detection occurs in either of the following cases:

- The temperature of the heat exchanger remains at or below the L1 line for 3 minutes after the start of HEAT operation.
- The temperature of the heat exchanger remains at or below the L2 line for 120 minutes after the start of HEAT operation.

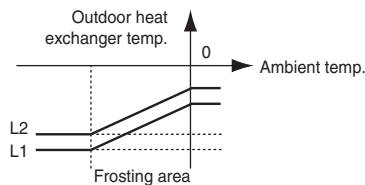

Reverse-cycle defrosting operation

- Compressor → 1 minute after it is stopped, compressor is ON.
- Outdoor fan → OFF
- Indoor fan → OFF
- 4-way valve → OFF
- Operation lamp → Repeatedly switches between red and orange illumination.

Releasing of defrosting

- Outdoor heating exchanger temp. is over 68°F(20°C).
- Defrosting operation lasts 12 minutes (maximum). 2 minutes after it is stopped, compressor is ON. 4-way valve is ON. Outdoor fan is ON.

NOTE

If the air conditioner is turned off during the defrosting cycle, it will continue defrosting and turn itself off after defrosting is completed.

■ CT (Peak current cut-off control)

- This function prevents the circuit breaker or fuse from operating to open the circuit. This function works when electrical current has increased due to an increase in the cooling / heating load, or to a decrease in the power supply voltage. In these cases, operation frequency is reduced or operation is interrupted automatically to control the electrical current for operation.
- When the cause of the increase in electrical current is rectified, the system will resume operation in the original mode.

<CS-KE12NB41> (A)

	Cooling • Dry	Heating
Peak current cut-off trips	22.5	
Hz down	14.0	15.0

<CS-KE18NB4UW> (A)

	Cooling • Dry	Heating
Peak current cut-off trips	17.5	
Hz down	11.0	14.0

NOTE Electrical current setting for COOL operation is used during DEFROST operation.

9. TROUBLESHOOTING (BEFORE CALLING FOR SERVICE)

9-1. Precautions before Performing Inspection or Repair

- After checking the self-diagnostics monitor, turn the power OFF before starting inspection or repair.
 - High-capacity electrolytic capacitors are used inside the outdoor unit controller (inverter). They retain an electrical charge (charging voltage DC 310V) even after the power is turned OFF, and some time is required for the charge to dissipate. Be careful not to touch any electrified parts before the controller LED (red) turns OFF.
- If the outdoor controller is normal, approximately 30 seconds will be required for the charge to dissipate. However, allow at least 5 minutes for the charge to dissipate if there is thought to be any trouble with the outdoor controller.

9-2. Method of Self-Diagnostics

Follow the procedure below to perform detailed trouble diagnostics.

NOTE

- 1: If the operation lamp blinks every 0.5 seconds immediately when the power is turned ON, there is an external ROM (OTP data) failure on the indoor circuit board, or a ROM socket insertion problem, or the ROM has not been installed.
- 2: The failure mode is stored in memory even when the power is not ON. Follow the procedure below to perform diagnostics.

PROCEDURE

After turning on power to the air conditioner, use the remote controller and follow the steps below to execute self-diagnostics.

Step 1: Press and hold the remote controller HIGH POWER button and 1 HR TIMER button. Then, press and hold the ACL (reset) button with a pointed object such as the tip of a pen. After 5 seconds, release ACL button first, then release HIGH POWER and 1 HR TIMER buttons, "oP-1" (test run) appears, blinking in the remote controller clock display area.

Step 2: Next, press the 1 HR TIMER button once to change the display from "oP-1" to "oP-3" (self-diagnostics). (The display continues to blink.)

Step 3: Finally press the ON/OFF button to engage self-diagnostics mode.

- The self-diagnostics function utilizes the 3 indicator lamps on the main unit, in combinations of ON lamps, blinking lamps, and OFF lamps, to report the existence of sensor trouble or a protective operation. (The lamps blink or remain ON for 5 seconds, then turn OFF for 2 seconds.) Self-diagnostics is completed when the buzzer sounds 3 short beeps.
- A maximum of 3 self-diagnostics reports are displayed, for 5 seconds each, beginning with the most recent report. Following this display the lamps turn OFF. In order to view the self-diagnostics results again, press the ON/OFF button again.
- The 3 lamps remain OFF if no trouble has occurred.

<IMPORTANT> After self-diagnostics is completed, be sure to press the ACL (reset) button to return to normal mode. The air conditioner will not operate if this is not done.

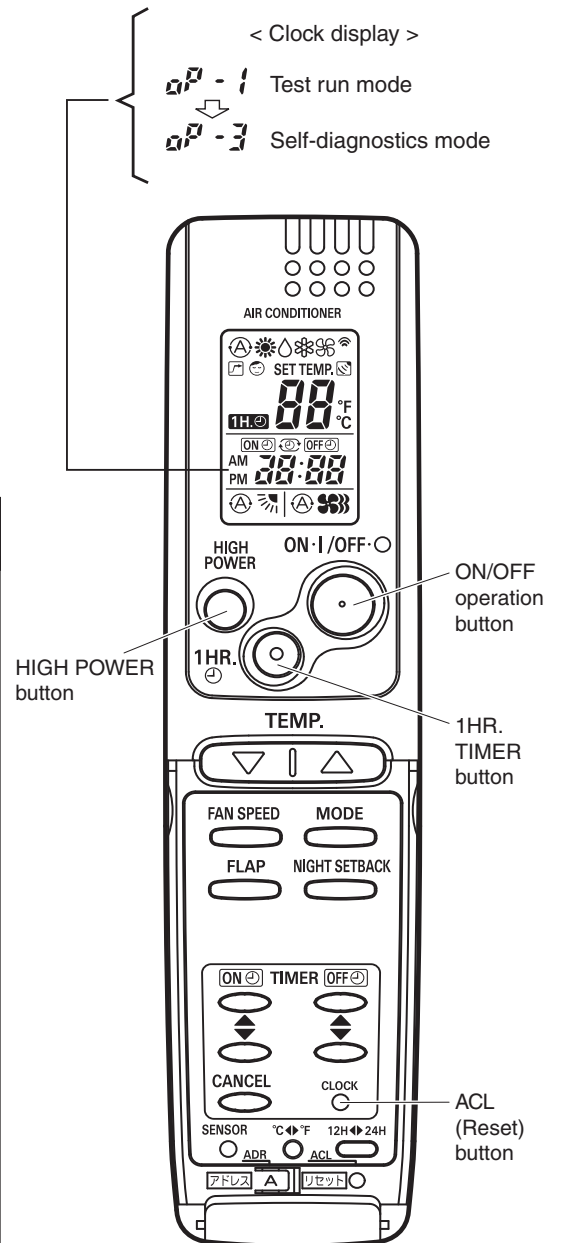

(1) Self-diagnostics Lamps

INDOOR UNIT

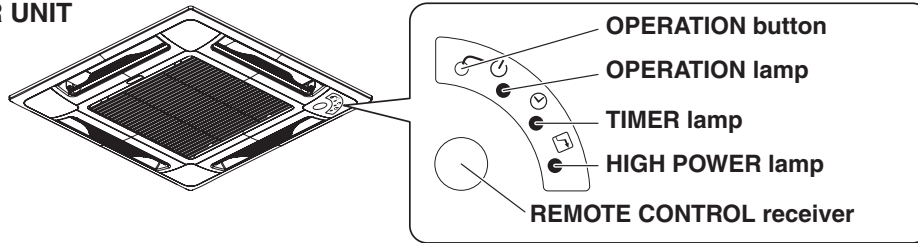

• Since the indications cover various units, the corresponding parts listed below may not be present in some models.

INDICATION ON INDOOR UNIT			× ... OFF ● ... BLINKING ☀ ... ON		
OPERATION ⏻	TIMER 🕒	HIGH POWER ⚡	CODE	DIAGNOSIS CONTENTS	POSSIBLE MALFUNCTION
●	×	×	S01	ROOM TEMP. SENSOR TROUBLE	(1) OPEN OR SHORT CIRCUIT IN SENSOR (2) POOR CONTACT AT CONNECTOR OR OPEN CIRCUIT AT TERMINAL PRESS-FIT LOCATION. (3) I/D PCB FAILURE (I/D = INDOOR)
×	●	×	S02	I/D HEAT EXCHANGER TEMP. SENSOR TROUBLE	
×	×	●	S04	COMPRESSOR TEMP. SENSOR TROUBLE	
●	×	●	S05	O/D HEAT EXCHANGER TEMP. SENSOR TROUBLE	(1) OPEN OR SHORT CIRCUIT IN SENSOR (2) POOR CONTACT AT CONNECTOR OR OPEN CIRCUIT AT TERMINAL PRESS-FIT LOCATION (3) O/D PCB FAILURE (O/D = OUTDOOR)
×	●	●	S06	O/D AIR TEMP. SENSOR TROUBLE	
●	●	●	S07	O/D CURRENT SENSOR ERROR	O/D PCB FAILURE
☀	×	×	E01	I/D-O/D COMMUNICATION TROUBLE (SERIAL COMMUNICATION TROUBLE)	(1) MIS-WIRING (2) AC POWER FAILURE (3) BLOWN FUSE (4) POWER RELAY FAILURE (5) I/D OR O/D PCB FAILURE (6) O/D FAN MOTOR FAILURE (7) REACTOR FAILURE (8) HIGH-PRESSURE SW FAILURE (9) OLR FAILURE (10) MAGNETIC COIL FAILURE
×	☀	×	E02	HIC CIRCUIT TROUBLE POWER TR CIRCUIT TROUBLE	(1) HIC OR POWER TR FAILURE (2) O/D FAN NOT OPERATING (3) INSTANTANEOUS POWER STOPPAGE (4) SERVICE VALVE NOT OPENED (5) O/D FAN BLOCKED (6) CONTINUOUS OVERLOAD OPERATION (7) COMPRESSOR FAILURE (8) O/D PCB FAILURE
☀	☀	×	E03	O/D UNIT EXTERNAL ROM TROUBLE	(1) EXTERNAL ROM DATA FAILURE (2) O/D PCB FAILURE
×	×	☀	E04	CURRENT PEAK CUT	(1) INSTANTANEOUS POWER STOPPAGE (2) HIC OR POWER TR FAILURE (3) O/D PCB FAILURE
☀	×	☀	E05	PAM CIRCUIT TROUBLE ACTIVE CIRCUIT TROUBLE	(1) O/D PCB FAILURE (2) O/D POWER VOLTAGE TROUBLE
×	☀	☀	E06	COMPRESSOR DISCHARGE TEMP. OVERHEATING PREVENTION	(1) ELECTRIC EXPANSION VALVE FAILURE (2) CHOKED CAPILLARY TUBE (3) INSUFFICIENT GAS (4) CONTINUOUS OVERLOAD OPERATION (5) O/D FAN NOT OPERATING (6) O/D PCB FAILURE
☀	☀	☀	E07	I/D FAN OPERATION TROUBLE	(1) FAN MOTOR FAILURE (2) CONNECTOR CONTACT FAILURE (3) I/D PCB FAILURE
☀	●	●	E08	4-WAY VALVE SWITCHING TROUBLE ZERO-CROSS TROUBLE	(1) 4-WAY VALVE FAILURE (HEAT PUMP MODEL ONLY) (2) O/D PCB FAILURE
●	☀	●	E09	GAS-LOSS PREVENTION	(1) SERVICE VALVE NOT OPENED (2) INSUFFICIENT GAS
☀	☀	●	E10	DC COMPRESSOR DRIVE CIRCUIT TROUBLE	(1) OPEN PHASE (2) O/D PCB FAILURE
●	●	☀	E11	O/D DC FAN OPERATION TROUBLE	(1) FAN MOTOR FAILURE (2) CONNECTOR CONTACT FAILURE (3) O/D PCB FAILURE
☀	●	☀	E12	O/D SYSTEM COMM FAILURE, OLR OPERATION, O/D POWER OPEN PHASE, O/D FREEZING	(1) MIS-WIRING (2) BLOWN FUSE (3) POWER RELAY FAILURE (4) O/D PCB FAILURE (5) COMPRESSOR FAILURE
●	☀	☀	E13	FREEZING-PREVENTION OPERATION	(1) I/D FAN SYSTEM TROUBLE (2) INSUFFICIENT GAS (3) OPERATION AT LOW TEMPERATURE
TIMER LAMP ⏻	⌚	BLINKING (3 SEC. INTERVAL)		FLOAT SWITCH (FS) IS ACTIVATED.	(1) DRAIN PUMP FAILURE (2) FS FAILURE (3) CHOKED DRAIN HOSE

8512-5261-99100-1

(2) If the self-diagnostics function fails to operate

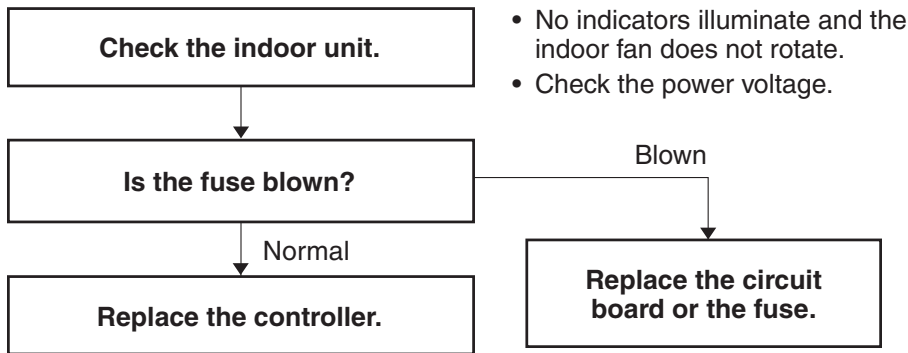

9-3. Checking the Indoor and Outdoor Units

(1) Checking the indoor unit

No.	Control	Check items (unit operation)
1	Use the remote controller to operate the unit in "TEST run" mode. To determine whether the mode is currently in "TEST run" mode, check the 3 indicator lamps on the unit. If all 3 are blinking, the current mode is "TEST run."	<ul style="list-style-type: none"> • The rated voltage must be present between inter-unit wirings 1 and 2. • Connect a 5 k ohm resistor between inter-unit wirings 2 and 3. When the voltage at both ends is measured, approximately 12 to 15V DC must be output and the multimeter pointer must bounce once every 8 seconds. Or instead of measuring the voltage, you can insert an LED jig and check that the LED flickers once every 8 seconds.

- If there are no problems with the above, then check the outdoor unit.
- For the "Test run" procedure, refer to the Appendix B "Installation Instructions".

(2) Checking the outdoor unit

No.	Control	Check items (unit operation)
1	Apply the rated voltage between outdoor unit terminals L and N.	• The control panel LED (red) must illuminate.
2	Short-circuit the outdoor unit COM terminal to the T-RUN terminal.	• The compressor, fan motor and 4-way valve must all turn on.

- If there are no problems with the above, then check the indoor unit.

● Using the TEST/T-RUN terminals



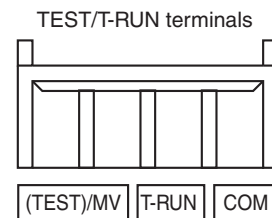



- T-RUN : Test run (compressor and fan motor turn ON).
- TEST/MV : Compresses time to 1/60th (accelerates operation by 60 times faster than normal).





(3) Serial Communication Error Identification Procedure

If the lamps on the main body show the following conditions after the completion of self-diagnostics, a communication error between the indoor unit and outdoor unit might be considered. In such a case, identify the breakdown section by using the following procedure.

NOTE Refer to "Method of Self-Diagnostics" for the self-diagnostics procedure.

Condition \ Lamp	Operation 	Timer 	High Power 
E01		×	×
E12			

× : Off
 : Blinking
 : Illuminated

< Before the Operation >



WARNING

For terminal strip short circuit work or inter-unit wiring removal, turn off the power to avoid an electric shock. Release the terminal strip short circuit after the completion of self-diagnostics.



CAUTION

Do not perform the short-circuit work between any other terminals except for specified ones on the specified terminal strip. If such work is performed between the incorrect terminals, the unit might be broken.

< Convenient Tool for Short-Circuit Work (for example) >

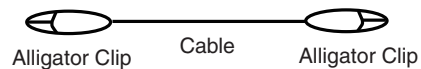

< Check Items before Troubleshooting Serial Communication Start >

After confirming that the following errors do not exist, start the "Troubleshooting Serial Communication" in "Condition: E01 and E12".

- | | |
|---|--|
| 1. Mis -wiring (inter-unit cable, etc.) | 6. Reactor failure (defective insulation, etc.) |
| 2. AC power failure | 7. High-Pressure Switch failure |
| 3. Blown fuse | 8. Overload Relay failure |
| 4. Power Relay failure | 9. Magnetic Coil failure (defective insulation, short-circuit, etc.) |
| 5. Outdoor Fan Motor failure (defective insulation, etc.) | 10. Compressor failure (defective insulation, etc.) |

(3-1) Condition: E01

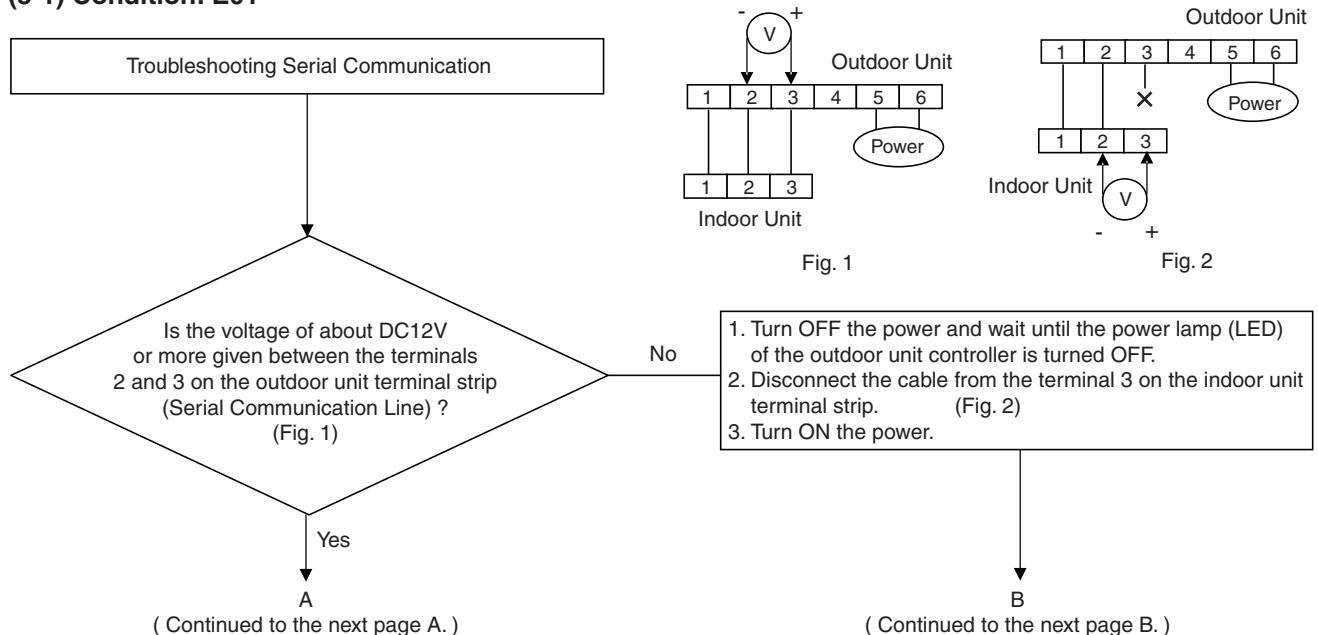

(Continued from the previous page A.)

(Continued from the previous page B.)

A

B

Yes

No

Defect or connection error in the inter-unit cable

Defect in the indoor unit P.C. board

1. Turn OFF the power and wait until the power lamp (LED) of the outdoor unit controller is turned OFF.
 2. Short-circuit between the terminals 2 and 3 on the outdoor unit terminal strip. (Fig. 3)

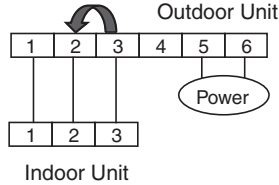
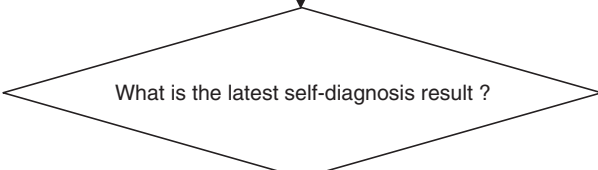

Fig. 3

1. Turn ON the power and operate the system using the remote controller or the operation button on the indoor unit.
 2. Perform the self-diagnosis five seconds after the operation start.



Condition: E12

Defect in the outdoor unit P.C. board.

Condition: E01

1. Turn off the power and wait until the power lamp (LED) of the outdoor unit controller is turned OFF.
 2. Remove the short-circuit between the terminals 2 and 3 on the outdoor unit terminal strip.
 3. Disconnect the cable from the terminal 3 on the indoor unit terminal strip. (Fig. 4)

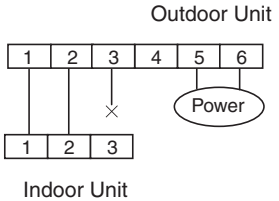

Fig. 4

Short-circuit between the terminals 2 and 3 on the indoor unit terminal board. (Fig. 5)

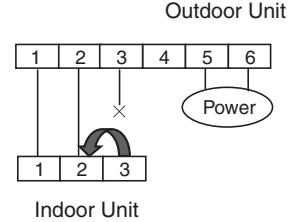
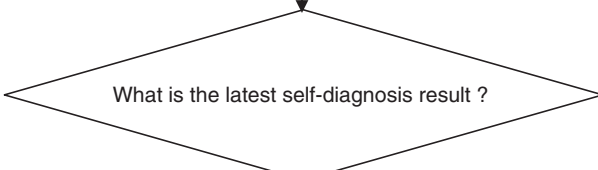

Fig. 5

1. Turn ON the power and operate the system using the remote controller or the operation button on the indoor unit.
 2. Perform the self-diagnosis five seconds after the operation start.



Condition: E12

Defect or connection error in the inter-unit cable

Condition: E01

Defect in the indoor unit P.C. board

(3-2) Condition: E12

Troubleshooting Serial Communication

1. Turn off the power and wait until the power lamp (LED) of the outdoor unit controller is turned OFF.
2. Disconnect the cable from the terminal 3 on the Outdoor unit terminal strip. (Fig. 6)

1. Turn ON the power and operate the system using the remote controller or the operation button on the indoor unit.
2. Perform the self-diagnosis five seconds after the operation start.

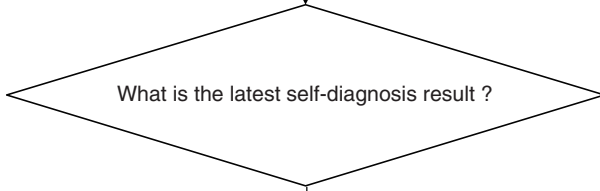

Condition: E01 → Defect in the outdoor unit P.C. board

Condition: E12

1. Turn off the power and wait until the power lamp (LED) of the outdoor unit controller is turned OFF.
2. Disconnect the cable from the terminal 3 on the indoor unit terminal strip. (Fig. 7)

1. Turn ON the power and operate the system using the remote controller or the operation button on the indoor unit.
2. Perform the self-diagnosis five seconds after the operation start.

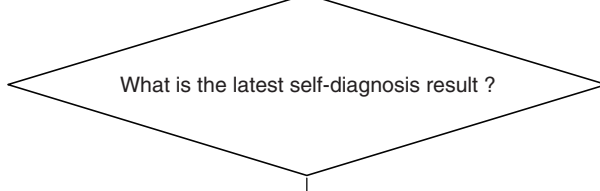

Condition: E01 → Defect in the inter-unit cable

Condition: E12

Defect in the indoor unit P.C. board

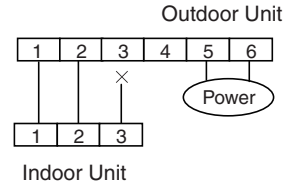

Fig. 6

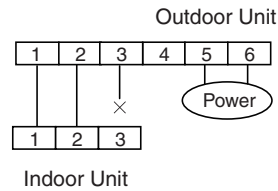

Fig. 7

9-4. Trouble Diagnosis of Fan Motor

9-4-1. Indoor Fan Motor

- This indoor DC fan motor contains an internal control PCB. Therefore, it is not possible to measure the coil resistance, and the following procedure should be used to check the motor.
- To perform diagnosis, operate the unit in cooling mode with indoor fan speed "High". Next, make sure that the indoor unit receive the signals from the remote controller when the ON/OFF operation button is pressed.

Important: (A) Turn OFF the power before connecting or disconnecting the motor connectors.
 (B) When performing voltage measurement at the indoor controller connector for (3) in the table below, the DC motor will trip and voltage output will stop approximately 1 minute after operation is started. For this reason, to measure the voltage again, turn OFF the unit once using the remote controller, and then start the air conditioner again.

[Trouble symptom 1] The fan does not stop when the unit stops. → Indoor unit controller trouble.

[Trouble symptom 2] The fan motor does not rotate when the unit is operating.

(Diagnostic procedure)

* Disconnect the motor connectors and measure the voltage at the DC motor connectors on the indoor unit controller (3 locations).

Measurement location	Normal value	
	CS-KE12NB41	CS-KE18NB4UW
(1) Vm-Gnd: Between pin 1 and pin 3	DC 130V to 195V	DC 280V to 340V
(2) Vcc-Gnd: Between pin 4 and pin 3	DC 15V +/- 10%	
(3) Vs-Gnd: Between pin 5 and pin 3	Fluctuation between DC 1.8V to 5.7V	

(Diagnostic results)

All of the above measured values are normal. → Fan motor trouble (Replace the motor.)

Any one of the above measured values is not normal. → Indoor unit controller trouble (Replace the controller.)

(Reference) DC motor connector pin arrangement

- Pin 1: Vm (red)
- Pin 2: Not used
- Pin 3: Gnd (black)
- Pin 4: Vcc (white)
- Pin 5: Vs (yellow)
- Pin 6: PG (blue)

[Trouble symptom 3] Motor rotates for some time (several seconds), but then quickly stops, when the indoor unit operates.

(There is trouble in the system that provides feedback of motor rotation speed from the motor to the indoor unit controller.)

[Trouble symptom 4] Fan motor rotation speed does not change during indoor unit operation.

[Trouble symptom 5] Fan motor rotation speed varies excessively during indoor unit operation.

(Remedy for symptom 3 to 5)

It is not possible to identify whether the trouble is indoor unit controller trouble or motor trouble. Therefore, first replace the indoor unit controller, then (if necessary) replace the DC motor.

9-4-2. Outdoor Fan Motor

- This outdoor DC fan motor contains an internal control PCB. Therefore, it is not possible to measure the coil resistance, and the following procedure should be used to check the motor.
- Perform the trouble diagnosis by Test Run mode described on Installation Instructions.

Important: (A) Turn OFF the power before connecting or disconnecting the motor connectors.
 (B) When performing voltage measurement at the outdoor controller connector for (3) in the table below, the DC motor will trip and voltage output will stop approximately 10 seconds after operation is started. For this reason, to measure the voltage again, first turn OFF the outdoor unit power, then, measure the voltage in Test Run mode.

[Trouble symptom 1] The fan does not stop when the outdoor unit stops. →Outdoor unit controller trouble

[Trouble symptom 2] The fan motor does not rotate when the outdoor unit is operating.

(Diagnostic procedure)

* Disconnect the motor connectors and measure the voltage at the DC motor connectors on the outdoor unit controller (3 locations).

Measurement location	Normal value
(1) Vs-Gnd: Between pin 1 and pin 4	DC 110V or more
(2) Vcc-Gnd: Between pin 5 and pin 4	DC 14V or more
(3) Vsp-Gnd: Between pin 7 and pin 4	After fluctuating 4 times between DC 1.0 to 4.3V (1 sec. ON) and DC 0 V (1 sec. OFF), the DC motor trips.

(Diagnostic results)

All of the above measured values are normal. → Fan motor trouble (Replace the motor.)

Any one of the above measured values is not normal. → Outdoor unit controller trouble
 (Replace the controller .)

(Reference) DC motor connector pin arrangement

- Pin 1: Vs (white)
- Pin 2: Not used
- Pin 3: Not used
- Pin 4: Gnd (black)
- Pin 5: Vcc (red)
- Pin 6: FG (blue)
- Pin 7: Vsp (yellow)

[Trouble symptom 3] Motor rotates for some time (several seconds), but then quickly stops, when the outdoor unit operates.

(There is trouble in the system that provides feedback of motor rotation speed from the motor to the outdoor unit controller.)

[Trouble symptom 4] Fan motor rotation speed does not change during outdoor unit operation.

[Trouble symptom 5] Fan motor rotation speed varies excessively during outdoor unit operation.

(Remedy for symptom 3 to 5)

It is not possible to identify whether the trouble is outdoor unit controller trouble or motor trouble. Therefore, first replace the outdoor unit controller, then (if necessary) replace the DC motor.

9-5. Noise Malfunction and Electromagnetic Interference

An inverter A/C operates using pulse signal control and high frequencies. Therefore, it is susceptible to the effects of external noise, and is likely to cause electromagnetic interference with nearby wireless devices.

A noise filter is installed for ordinary use, preventing these problems. However, depending on the installation conditions, these effects may still occur. Please pay attention to the points listed below.

(1) Noise malfunction

This refers to the application of high-frequency noise to the signal wires, resulting in abnormal signal pulses and malfunction.

Locations most susceptible to noise	Trouble	Correction
<ol style="list-style-type: none"> Locations near broadcast stations where there are strong electromagnetic waves Locations near amateur radio (short wave) stations Locations near electronic sewing machines and arc-welding machines 	<p>Either of the following trouble may occur.</p> <ol style="list-style-type: none"> The unit may stop suddenly during operation. Indicator lamps may flicker. 	<p>(The fundamental concept is to make the system less susceptible to noise.)</p> <p>- Insulate for noise or distance from the noise source. -</p> <ol style="list-style-type: none"> Use shielded wires. Move unit away from the noise source.

(2) Electromagnetic interference

This refers to noise generated by high-speed switching of the microcomputer and compressor. This noise radiates through space and returns to the electric wiring, affecting any wireless devices (televisions, radios, etc.) located nearby.

Locations most susceptible to noise	Trouble	Correction
<ol style="list-style-type: none"> A television or radio is located near the A/C and A/C wiring. The antenna cable for a television or radio is located close to the A/C and A/C wiring. Locations where television and radio signals are weak. 	<ol style="list-style-type: none"> Noise appears in the television picture, or the picture is distorted. Static occurs in the radio sound. 	<ol style="list-style-type: none"> Select a separate power source. Keep the A/C and A/C wiring at least 1 meter away from wireless devices and antenna cables. Change the wireless device's antenna to a high-sensitivity antenna. Change the antenna cable to a BS coaxial cable. Use a noise filter (for the wireless device). Use a signal booster.

10. CHECKING ELECTRICAL COMPONENTS

10-1. Measurement of Insulation Resistance

- The insulation is in good condition if the resistance exceeds 1M ohm.

10-1-1. Power Supply Cord

Clamp the grounding wire of power cord with the lead clip of the insulation resistance tester and measure the resistance by placing a probe on either of the two power wires. (Fig. 1)

Then also measure the resistance between the grounding and other power terminals. (Fig. 1)

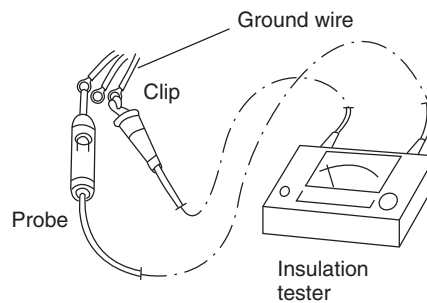

Fig. 1

10-1-2. Indoor Unit

Clamp an aluminum plate fin or copper tube with the lead clip of the insulation resistance tester and measure the resistance by placing a probe on each terminal screw on the terminal plate. (Fig. 2)

Note that the ground line terminal should be skipped for the check.

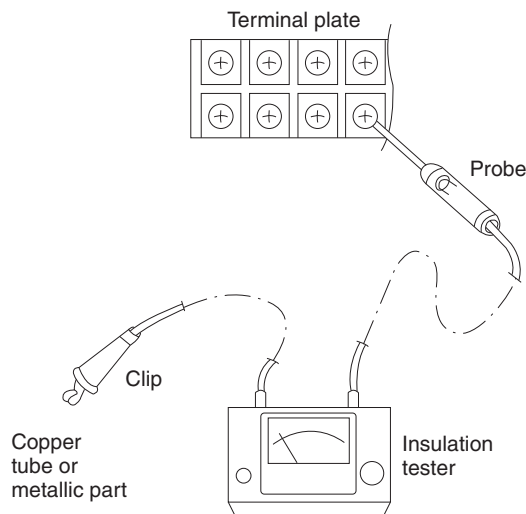

Fig. 2

10-1-3. Outdoor Unit

Clamp a metallic part of the unit with the lead clip of the insulation resistance tester and measure the resistance by placing a probe on each terminal screw where power supply lines are connected on the terminal plate. (Fig. 2)

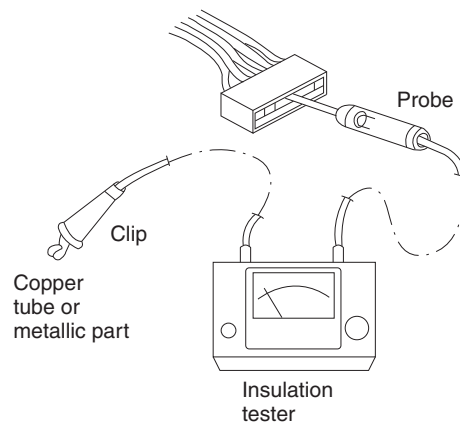

Fig. 3

10-1-4. Measurement of Insulation Resistance for Electrical Parts

Disconnect the lead wires of the desired electric part from terminal plate, capacitor, etc. Similarly disconnect the connector. Then measure the insulation resistance. (Figs. 3 and 4)

NOTE

Refer to Electric Wiring Diagram.

If the probe cannot enter the poles because the hole is too narrow then use a probe with a thinner pin.

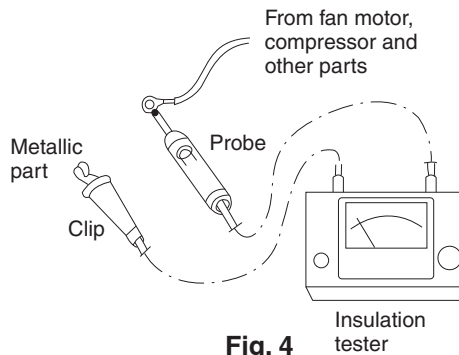

Fig. 4

10-2. Checking Continuity of Fuse on PCB Ass'y

- Remove the PCB Ass'y from the electrical component box. Then pull out the fuse from the PCB Ass'y. (Fig. 5)
- Check for continuity using a multimeter as shown in Fig. 6.

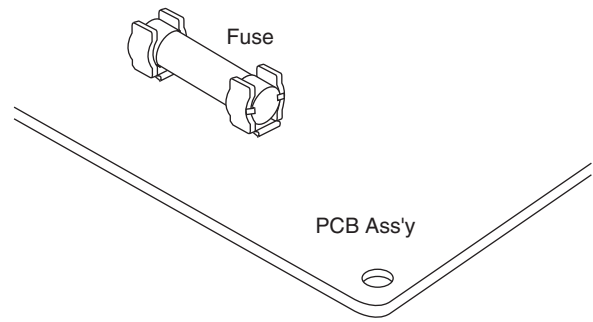

Fig. 5

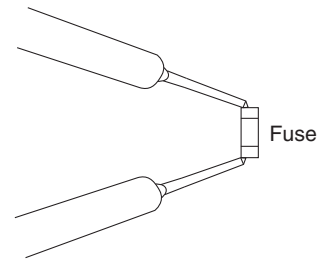

Fig. 6

11. REFRIGERANT R410A: SPECIAL PRECAUTIONS WHEN SERVICING UNIT

11-1. Characteristics of New Refrigerant R410A

11-1-1. What is New Refrigerant R410A?

R410A is a new refrigerant that contains two types of pseudo-non-azeotropic refrigerant mixture. Its refrigeration capacity and energy efficiency are about the same level as the conventional refrigerant, R22.

11-1-2. Components (mixing proportions)

HFC32 (50%) / HFC125 (50%)

11-1-3. Characteristics

- Less toxic, more chemically stable refrigerant
- The composition of refrigerant R410A changes whether it is in a gaseous phase or liquid phase. Thus, when there is a refrigerant leak the basic performance of the air conditioner may be degraded because of a change in composition of the remaining refrigerant. **Therefore, do not add new refrigerant.** Instead, recover the remaining refrigerant with the refrigerant recovery unit. Then, after evacuation, totally recharge the specified amount of refrigerant with the new refrigerant at its normal mixed composition state (in liquid phase).
- When refrigerant R410A is used, the composition will differ depending on whether it is in gaseous or liquid phase, and the basic performance of the air conditioner will be degraded if it is charged while the refrigerant is in gaseous state. **Thus, always charge the refrigerant while it is in liquid phase.**



CAUTION

Ether-type oil is used for compressor oil for R410A-type units, which is different from the mineral oil used for R22. Thus more attention to moisture prevention and faster replacement work compared with conventional models are required.

11-2. Checklist before Servicing

Use a clutch-type flare tool for R410A or the conventional flare tool. Note that sizes of the resultant flares differ between these two tools. Where a conventional flare tool is used, make sure to observe A Specification (amount of extrusion) by using the flare spacer.

Diameter of tube D	Specification A	
	Flare tool for R410A	Conventional flare tool (for R22)
Dia. 1/4" (6.35 mm)	0 to 0.0196" (0 to 0.5 mm)	0.0472" (1.2 mm)
Dia. 3/8" (9.52 mm)		
Dia. 1/2" (12.7 mm)		
Dia. 5/8" (15.88 mm)		

● Size of flare

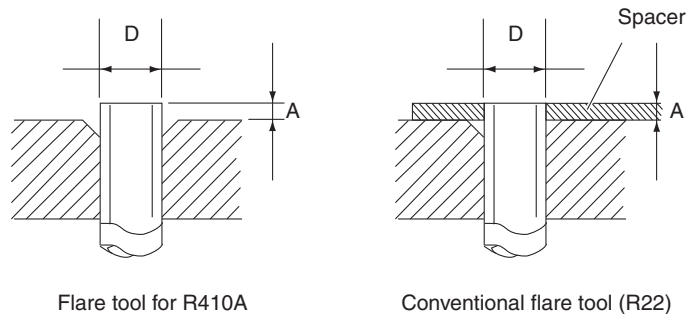

● Tubing precautions

- Refrigerant R410A is more easily affected by dust or moisture compared with R22, thus be sure to temporarily cover the ends of the tubing with caps or tape prior to installation.

Never use 0.0276" (0.7 mm)-thick copper tubing or tubing which is less than 0.0315" (0.8 mm) in thickness, since air conditioners with R410A are subject to higher pressure than those using R22 and R407C.

● No addition of compressor oil for R410A

No additional charge of compressor oil is permitted.

● No use of refrigerant other than R410A

Never use a refrigerant other than R410A.

● If refrigerant R410A is exposed to fire

Through welding, etc., toxic gas may be released when R410A refrigerant is exposed to fire. Therefore, be sure to provide ample ventilation during installation work.

● Caution in case of R410A leak

Check for possible leak points with the special leak detector for R410A. If a leak occurs inside the room, immediately provide thorough ventilation.

11-3. Tools Specifically for R410A

- For servicing, use the following tools for R410A

Tool Distinction	Tool Name
Tools specifically for R410A	<ul style="list-style-type: none"> ● Gauge manifold ● Charging hose ● Gas leak detector ● Refrigerant cylinder ● Charging cylinder ● Refrigerant recovery unit ● Vacuum pump with anti-reverse flow (*1) (Solenoid valve-installed type, which prevents oil from flowing back into the unit when the power is off, is recommended.) ● Vacuum pump (*2)...can be used if the following adapter is attached. ● Vacuum pump adapter (reverse-flow prevention adapter) (*3). (Solenoid valve-installed adapter attached to a conventional vacuum pump.) ● Electronic scale for charging refrigerant ● Flare tool
Tools which can be commonly used for R22, R407C, and R410A	<ul style="list-style-type: none"> ● Bender ● Torque wrench ● Cutter, reamer ● Welding tool, nitrogen gas cylinder



CAUTION

- **The above tools specifically for R410A must not be used for R22 and R407C. Doing so will cause malfunction of the unit.**
- **For the above vacuum pump (*1, *2) and vacuum pump adapter (*3), those for R22-type units can be used for R410A-type. However, they must be used exclusively for R410A and never alternately with R22 and R407C.**
- To prevent other refrigerants (R22, R407C) from being mistakenly charged to this unit, shape and external diameter of the service port screw has been altered.
 <External diameter of service port> R410A : 5/16"
 R22, R407C : 1/4"

11-4. Tubing Installation Procedures

When the tubes are connected, **always apply HAB oil on the flare portions to improve the sealing of tubing.**

The following is the **HAB oil** generally used:

Esso: ZERICE S32

NOTE For details on tubing installation procedures, refer to the installation manuals attached to the indoor unit and outdoor unit.

11-5. In Case of Compressor Malfunction



CAUTION

- Should the compressor malfunction, be sure to make the switch to a replacement compressor as quickly as possible.
- Use only the tools indicated exclusively for R410A. → See "11-3. Tools Specifically for R410A."

11-5-1. Procedure for Replacing Compressor

(1) Recovering refrigerant

- Any remaining refrigerant inside the unit should not be released to the atmosphere, but recovered using the refrigerant recovery unit for R410A.
- Do not reuse the recovered refrigerant, since it will contain impurities.

(2) Replacing Compressor

- Soon after removing seals of both discharge and suction tubes of the new compressor, replace it quickly.

(3) Checking for sealing

- Use nitrogen gas for the pressurized gas, and never use a refrigerant other than R410A. Also do not use oxygen or any flammable gas.

(4) Evacuation

- **Use a solenoid valve-installed vacuum pump** so that even if power is cut off in the middle of evacuation of air due to a power interruption, the valve will prevent the pump oil from flowing back.
- The equipment may be damaged if moisture remains in the tubing, thus carry out the evacuation thoroughly.
- When using a vacuum pump with exhaust air volume more than 0.883 cu.ft./min. and ultimate vacuum pressure rate of 50 micron Hg.

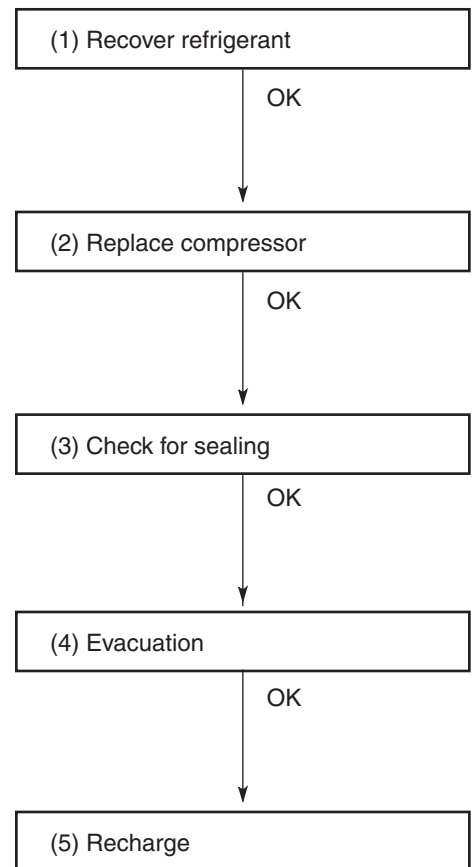

Standard time for evacuation

Length of tubing	Less than 33 ft. (10 m)	More than 33 ft. (10 m)
Evacuation time	More than 10 minutes	More than 15 minutes

(5) Recharging

- **Be sure to charge the specified amount of refrigerant in liquid state** using the service port of the wide tube service valve. The proper amount is listed on the unit's nameplate.

When the entire amount cannot be charged all at once, charge gradually while operating the unit in Cooling Operation.



CAUTION

Never charge a large amount of liquid refrigerant at once to the unit. This may cause damage to the compressor.

- When charging with a refrigerant cylinder, use an electronic scale for charging refrigerant. In this case, if the volume of refrigerant in the cylinder becomes less than 20% of the fully-charged amount, the composition of the refrigerant starts to change. Thus, **do not use the refrigerant if the amount in the charging cylinder is less than 20%.**

Also, charge the minimum necessary amount to the charging cylinder before using it to charge the air conditioning unit.

Example:

In case of charging refrigerant to a unit requiring 1.68 lb. (0.76 Kg) using a capacity of a 22 lb. (10 Kg) cylinder, the minimum necessary amount for the cylinder is:

$$1.68 + 22 \times 0.20 = 6.08 \text{ lb.}$$

$$(0.76 + 10 \times 0.20 = 2.76 \text{ Kg})$$

- **For the remaining refrigerant, refer to the instructions of the refrigerant manufacturer.**

If using a charging cylinder, transfer the specified amount of liquid refrigerant from the refrigerant cylinder to the charging cylinder.

Prepare an evacuated charging cylinder beforehand.



CAUTION

- **To prevent the composition of R410A from changing, never bleed the refrigerant gas into the atmosphere while transferring the refrigerant. (Fig. 3)**

Do not use the refrigerant if the amount in the charging cylinder is less than 20%.

Configuration and characteristics of cylinders

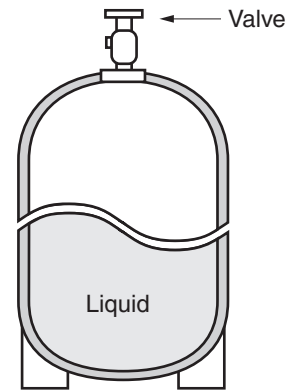

Single valve

Charge liquid refrigerant with cylinder in up-side-down position.

Fig. 1

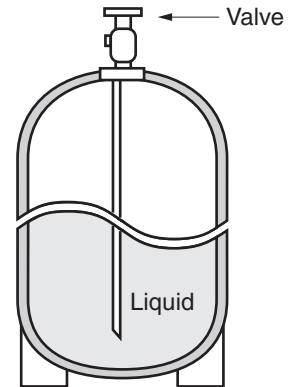

Single valve (with siphon tube)

Charge with cylinder in normal position.

Fig. 2

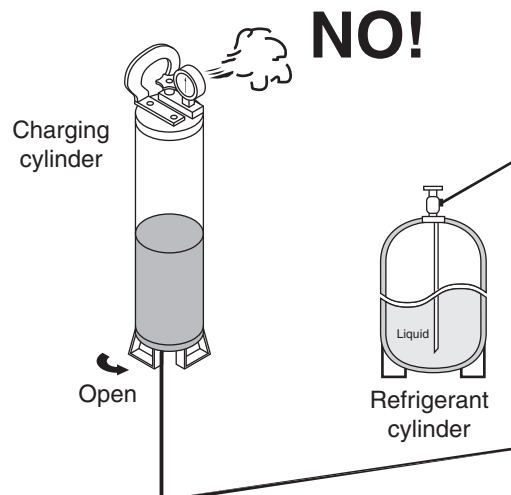

Fig. 3

11-6. In Case Refrigerant is Leaking



CAUTION

Never attempt to charge additional refrigerant when refrigerant has been leaking from the unit. Follow the procedure described below to locate points of leaks and carry out repairs, then recharge the refrigerant.

(1) Detecting Leaks

- Use the detector for R410A to locate refrigerant leak points.

(2) Recovering refrigerant

- Never release the gas to the atmosphere; recover residual refrigerant using the refrigerant recovery unit for R410A, instead.
- Do not reuse the recovered refrigerant because its composition will have been altered.

(3) Welding leaking points

- Confirm again that no residual refrigerant exists in the unit before starting welding.
- Weld securely using flux and wax for R410A.
- Prevent oxide film from forming inside the tubes utilizing substitution with nitrogen (N₂) in the refrigerant circuit of the unit. Leave ends of tubes open during welding.

(4) Checking for sealing

- Use nitrogen gas for the pressurized gas, and never use a refrigerant other than R410A. Also do not use oxygen or any flammable gas.

(5) Evacuation

- **Use a solenoid valve-installed vacuum pump** so that even if power is cut off in the middle of evacuation of air due to a power interruption, the valve will prevent the pump oil from flowing back.
- The equipment may be damaged if moisture remains in the tubing, thus carry out the evacuation thoroughly.
- When using a vacuum pump with exhaust air volume more than 0.883 cu.ft./min. and ultimate vacuum pressure rate of 50 micron Hg.

Standard time for evacuation

Length of tubing	Less than 33 ft. (10 m)	More than 33 ft. (10 m)
Evacuation time	More than 10 minutes	More than 15 minutes

(6) Recharging

- Recharge unit in the same manner explained on the previous page "(5) Recharging."

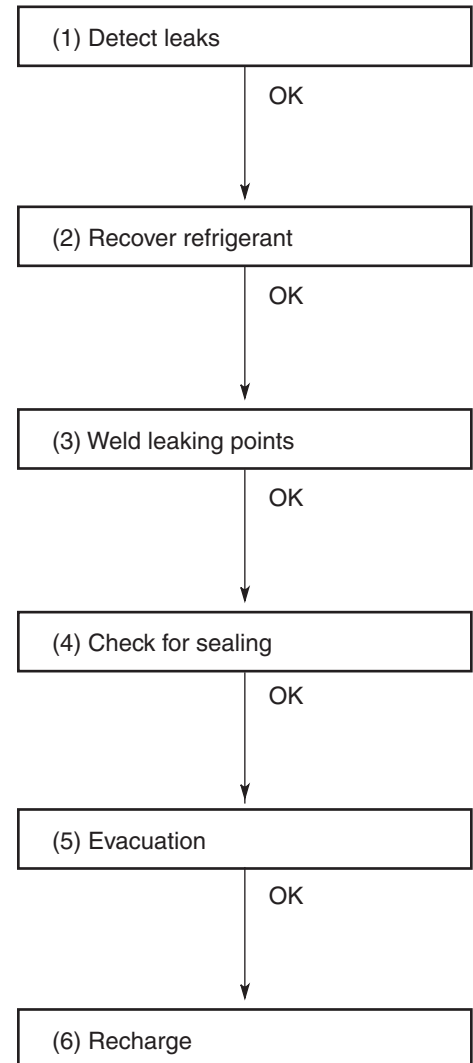

11-7. Charging Additional Refrigerant

11-7-1. When Tubes are Extended

- Observe the proper amount of refrigerant as stated in this service manual or the installation manual that came with the indoor unit. **Charge additional refrigerant in liquid state only.**



CAUTION

Never charge additional refrigerant if refrigerant is leaking from the unit. Follow instructions given in "11-6. In Case Refrigerant is Leaking" and completely carry out repairs. Only then should you recharge the refrigerant.

11-8. Retro-Fitting Existing Systems

11-8-1. Use of Existing Units

- **Never use new refrigerant R410A for existing units which use R22.** This will cause the air conditioner to operate improperly and may result in a hazardous condition.

11-8-2. Use of Existing Tubing

- If replacing an older unit that used refrigerant R22 with a R410A unit, **do not use its existing tubing.** Instead, completely new tubing must be used.

APPENDIX A Operating Instructions

**CS-KE12NB41 & CZ-18BT1U + CU-KE12NK1
CS-KE18NB4UW & CZ-18BT1U + CU-KE18NKU**

(852-6-4181-213-00-2)

Operating Instructions Split System Air Conditioner

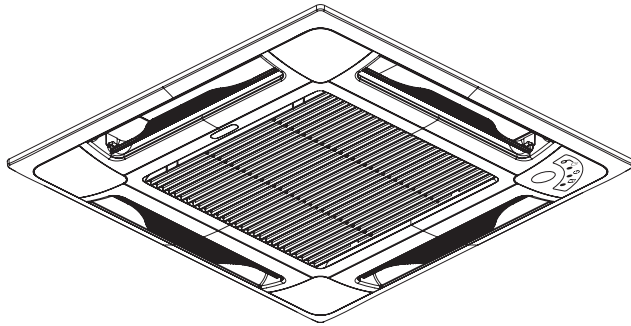

Model No.

Indoor Units

CS-KE12NB41

CS-KE18NB4UW

Outdoor Units

(For Single use)

CU-KE12NK1

CU-KE18NKU

(For Multiple use)

CU-3KE19NBU

CU-4KE24NBU

CU-4KE31NBU

Ceiling Panel

CZ-18BT1U

This air conditioner uses the refrigerant R410A.

**“Multiple use” is applied for the model
CS-KE18NB4UW only.**

- “Single use” means that only one indoor unit is connected with one outdoor unit in a one-unit-to-one-unit configuration and that the remote controller’s S/M switch is at the “S” (Single) position.
- “Multiple use” (i.e. Flexi-Multi system) means that two or more indoor units are connected with one outdoor unit in a multiple-unit-to-one-unit configuration and that the remote controller’s S/M switch is at the “M” (Multiple) position. (Refer to “USING THE REMOTE CONTROLLER” on page 8.)



Before operating the unit, read these operating instructions thoroughly and keep them for future reference.

FEATURES

This air conditioner is an inverter type unit that automatically adjusts capability as appropriate. Details on these functions are provided below; refer to these descriptions when using the air conditioner.

- **Microprocessor Controlled Operation**
The interior compartment of the remote controller contains several features to facilitate automatic operation, easy logically displayed for easy use.
- **Simple One-touch Remote Controller**
The remote controller has several features to facilitate automatic operation.
- **24-Hour ON or OFF Timer**
This timer can be set to automatically turn the unit on or off at any time within a 24 hour period.
- **1-Hour OFF Timer**
This timer can be set to automatically turn off the unit at any time after one hour.
- **Night Setback**
This function saves energy by controlling operation to provide a quieter operating sound than normal.
- **Automatic and 3-step Fan Speed**
Auto/High/Medium/Low
- **Air Sweep Control**
This function moves a flap up and down in the air outlet, directing air in a sweeping motion around the room and providing comfort in every corner.
- **Auto. Flap Control**
This automatically sets the flap to the optimum position during heating, cooling, and drying operation.

- **Automatic Switching between Cooling and Heating**
When the remote controller's S/M switch is at the "S" (Single) position
This unit automatically switches between cooling operation and heating operation according to the difference between the room temperature and the temperature setting.
When the remote controller's S/M switch is at the "M" (Multiple) position
Unlike when the switch is at the "S" position as described above, the function for automatically switching between cooling and heating does not work. Then, the air conditioner continuously operates under the mode selected at initial operation.
- **Hot Start Heating System**
Right from the start, the air is warm and comfortable. This system prevents any cold blasts at the beginning while the heat pump is warming up, or even defrosting.
- **Automatic Restart Function for Power Failure**
Even when power failure occurs, preset programmed operation can be reactivated once power resumes.
- **High Power Operation**
If not in Auto Operation, the unit operates at maximum output for 30 minutes, regardless of the desired temperature.
The fan speed is 1 step above "High".

CONTENTS

	Page		Page
FEATURES	2	SPECIAL REMARKS	11
PRODUCT INFORMATION	2	SETTING THE TIMER	11
SAFETY PRECAUTIONS	2	USING THE 1-HOUR OFF TIMER	13
INSTALLATION LOCATION	3	TIPS FOR ENERGY SAVING	13
ELECTRICAL REQUIREMENTS	3	ADJUSTING THE AIRFLOW DIRECTION	13
SAFETY INSTRUCTIONS	3	OPERATION WITHOUT THE REMOTE CONTROLLER	14
NAMES OF PARTS	4	CARE AND CLEANING	14
USING THE REMOTE CONTROLLER	8	TROUBLESHOOTING (BEFORE CALLING FOR SERVICE) ..	16
OPERATION WITH THE REMOTE CONTROLLER	9	OPERATING RANGE	16
1. Automatic Operation	9	WIRED REMOTE CONTROLLER	16
2. Manual Operation	9	SPECIFICATIONS	17
3. Adjusting the Fan Speed	10		
4. Fan Only	10		
5. Night Setback Mode	10		
6. HIGH POWER Mode	10		

PRODUCT INFORMATION

If you have problems or questions concerning your Air Conditioner, you will need the following information. Model and serial numbers are on the nameplate on the bottom of the cabinet.

Model No. _____

Serial No. _____

Date of purchase _____

Dealer's address _____

Phone number _____

SAFETY PRECAUTIONS

The following symbols used in this manual, alert you to potentially dangerous conditions to users, service personnel or the appliance:



WARNING

This symbol refers to a hazard or unsafe practice which can result in severe personal injury or death.



CAUTION

This symbol refers to a hazard or unsafe practice which can result in personal injury or product or property damage.

INSTALLATION LOCATION

- We recommend that this air conditioner be installed properly by qualified installation technicians in accordance with the Installation Instructions provided with the unit.
- Before installation, check that the voltage of the electric supply in your home or office is the same as the voltage shown on the nameplate.



WARNING

- Do not install this air conditioner where there are fumes or flammable gases, or in an extremely humid space such as a greenhouse.
- Do not install the air conditioner where excessively high heat-generating objects are placed.

Avoid:

To protect the air conditioner from heavy corrosion, avoid installing the outdoor unit where salty sea water can splash directly onto it or in sulphurous air near a spa.

ELECTRICAL REQUIREMENTS

1. All wiring must conform to the local electrical codes. Consult your dealer or a qualified electrician for details.
2. Each unit must be properly grounded with a ground (or earth) wire or through the supply wiring.
3. Wiring must be done by a qualified electrician.

NOTE

Pull off the power plug from a receptacle, or switch off the breaker, or switch off the power disconnecting mean to isolate the air conditioner from the main power supply when not in use for a long time.



SAFETY INSTRUCTIONS

- Read this Instruction Manual carefully before using this air conditioner. If you still have any difficulties or problems, consult your dealer for help.
- This air conditioner is designed to give you comfortable room conditions. Use this only for its intended purpose as described in this Instruction Manual.







WARNING

- Confirm to authorized dealer or specialist on usage of specified refrigerant type. Using of refrigerant other than the specified type may cause product damage, burst and injury etc.
- Never touch the unit with wet hands.
- Never use or store gasoline or other flammable vapor or liquid near the air conditioner — it is very dangerous.
- Do not use this appliance in a potentially explosive atmosphere.
- This air conditioner has no ventilator for intaking fresh air from outdoors. You must open doors or windows frequently when you use gas or oil heating appliances in the same room, which consume a lot of oxygen from the air. Otherwise there is a risk of suffocation in an extreme case.
- Do not swallow the battery.
- After removing the battery from remote controller, keep it away from the reach of children. The battery can cause death by suffocation if swallowed.
- When inserting the battery, make sure the polarities (+ and -) are correct.

- To prevent possible hazards from insulation failure, the unit must be grounded. 
- Do not clean inside the indoor and outdoor units by users. Engage authorized dealer or specialist for cleaning.
- In case of malfunction of this appliance, do not repair by yourself. Contact to the sales dealer or service dealer for a repair.
- Refrigerant gas leakage may cause fire.
- For safety, be sure to turn the air conditioner off and also to disconnect the power before cleaning. 
- Pull off the power plug from a receptacle, or switch off the breaker, or switch off the power disconnecting mean to isolate the air conditioner from the main power supply in case of emergency.



CAUTION

- Do not turn the air conditioner on and off from the power mains switch. Use the ON/OFF operation button.
- Do not stick anything into the air outlet of the outdoor unit. This is dangerous because the fan is rotating at high speed. 
- Do not touch the air inlet or the sharp aluminum fins of the outdoor unit. You may get injured. 
- Keep the fire alarm and the air outlet at least 1.5m away from the unit.
- Do not let children play with the air conditioner.
- Do not cool or heat the room too much if babies or invalids are present.
- Do not sit or step on the unit. You may fall down accidentally. 
- Do not stick any object into the FAN CASE. You may be injured and the unit may be damaged. 



NOTICE

- This device complies with part 15 of the FCC Rules. Operation is subject to the following two conditions:
(1) This device may not cause harmful interference, and (2) this device must accept any interference received, including interference that may cause undesired operation.
- This equipment has been tested and found to comply with the limits for a Class B digital device, pursuant to part 15 of the FCC Rules.
These limits are designed to provide reasonable protection against harmful interference in a residential installation. This equipment generates, uses and can radiate radio frequency energy and, if not installed and used in accordance with the instructions, may cause harmful interference to radio communications. However, there is no guarantee that interference will not occur in a particular installation. If this equipment does cause harmful interference to radio or television reception, which can be determined by turning the equipment off and on, the user is encouraged to try to correct the interference by one or more of the following measures:
 - Reorient or relocate the receiving antenna.
 - Increase the separation between the equipment and receiver.
 - Connect the equipment into an outlet on a circuit different from that to which the receiver is connected.
 - Consult the dealer or an experienced radio/TV technician for help.
- FCC Caution: To assure continued compliance, follow the attached installation instructions. Any changes or modifications not expressly approved by the party responsible for compliance could void the user's authority to operate this equipment.

NAMES OF PARTS

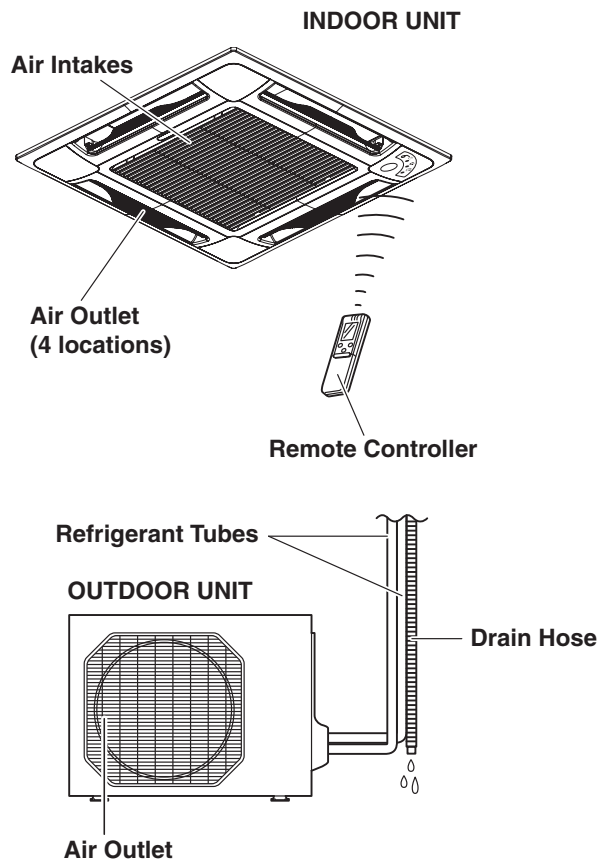

NOTE

This illustration is based on the external view of a standard model. Consequently, the shape may differ from that of the air conditioner which you have selected.

This air conditioner consists of an indoor unit and an outdoor unit. You can control the air conditioner with the remote controller.

Air Intake	Air from the room is drawn into this section and passes through air filters which remove dust.
Air Outlet	Conditioned air is blown out of the air conditioner through the air outlet.
Remote Controller	The remote controller controls power ON/OFF, operation mode selection, temperature, fan speed, timer setting, and air sweeping.
Refrigerant Tubes	The indoor and outdoor units are connected by copper tubes through which refrigerant gas flows.
Drain Hose	Moisture in the room condenses and drains off through this hose.
Outdoor (Condensing) Unit	The outdoor unit contains the compressor, fan motor, heat exchanger coil, and other electrical components.

UNIT DISPLAY AND OPERATION BUTTON

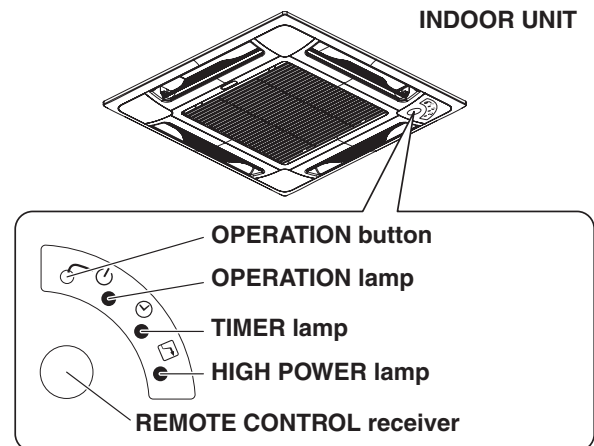

IMPORTANT

Avoid using radio equipment such as mobile phone near (within 4 ft. (1.2 m)) the remote control receiver. Some radio equipment may cause malfunction of the unit.

If the trouble happens, disconnect power and restart the air conditioner after a few minutes.

REMOTE CONTROL receiver	This section picks up infrared signals from the remote controller (transmitter).
OPERATION button	When the remote controller cannot be used, pressing this button enables heating and cooling operation. Each time this button is pressed, the type of operation conducted is indicated by the changing color of the OPERATION lamp. Press the button and select the lamp color that suits your preference for operation. Cooling operation (green) → Heating operation (red) → Stop (lamp off)
OPERATION lamp	This lamp lights when the system is in the continuous AUTO (red or green), HEAT (red), DRY (orange), COOL (green) and FAN (green) mode (but no FAN mode at M of the S/M switch on the remote controller). The OPERATION lamp lights up red and orange alternately when the system is defrosting.
TIMER lamp	This lamp lights when the system is being controlled by the timer.
HIGH POWER lamp	This lamp lights during operation in the HIGH POWER mode.

NOTE

The unit's display lamps are dimmed during operation in the NIGHT SETBACK mode.

REMOTE CONTROLLER (DISPLAY)

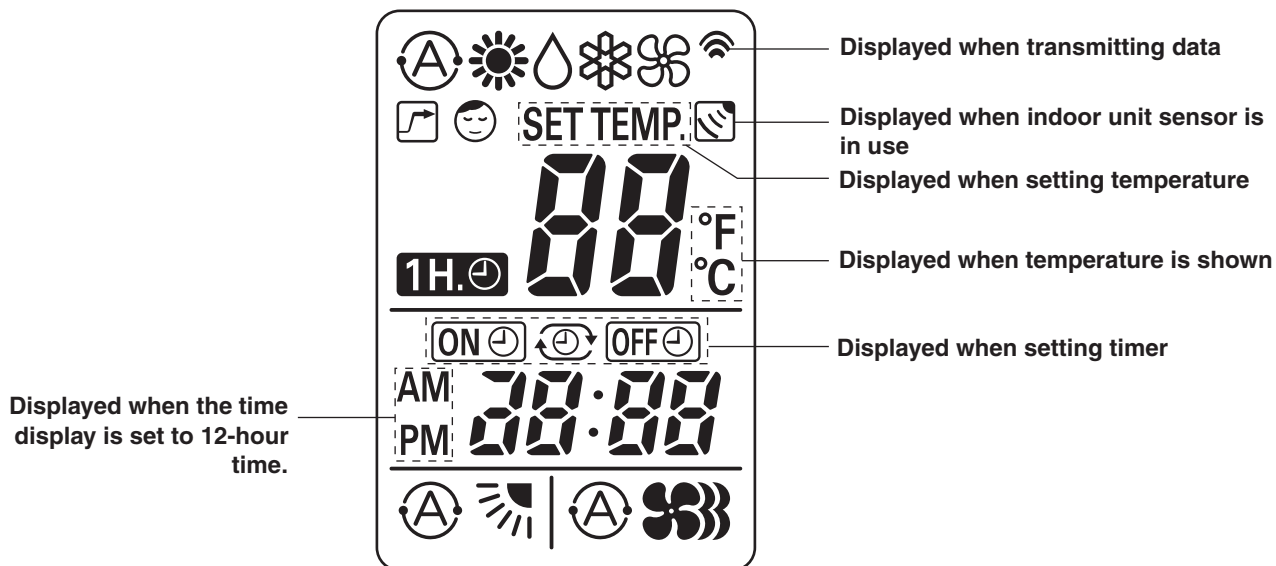

EG

Symbols

(1) Operation mode

- AUTO
- HEAT
- MILD DRY
- COOL
- FAN

(2) Fan speed

- Automatic operation
- HIGH
- MEDIUM
- LOW

(3) Temperature setting

- 60 – 86 °F
When set to 80 °F
temperature indication

(4) Timer

- 24-hour clock with ON/OFF
program Timer
- ON Timer.
- OFF Timer.
- 1-hour OFF Timer.

(5) NIGHT SETBACK.....



(6) Confirmation

- of transmission.....

(7) Auto. flap indication.....



Flap angle indication.....



Sweep indication.....



(8) High power operation.....



REMOTE CONTROLLER

Transmitter

When you press the buttons on the remote controller, the  mark appears in the display to transmit the setting changes to the receiver in the air conditioner.





Display

Information on the operating conditions is displayed while the remote controller is switched on. If the unit is turned off, FLAP setting and FAN SPEED setting are not displayed.

HIGH POWER button



-  : If this button is pressed during HEAT, DRY, COOL or FAN operation, the unit operates at maximum output for 30 minutes, regardless of the desired temperature. The fan speed is 1step above "HIGH".

FAN SPEED selector button

-  : The air conditioner automatically decides the fan speeds.
-  : High fan speed
-  : Medium fan speed
-  : Low fan speed

FLAP button

Press this button either to select the setting of the airflow direction to the auto. flap in each mode or one of the six possible positions manually or to select the sweep function which moves the flap up and down automatically.

-  : Auto flap setting: If selected in a heating operation, the flap is set to position (3) in the following chart. If selected in a cooling or dry operation, the flap is set at position (7) in the following chart.
-  : The airflow direction can be set manually. (six positions)
-  : The flap moves up and down automatically.

NOTE

When you press the FLAP button, the air flow direction will be changed one by one as follows.

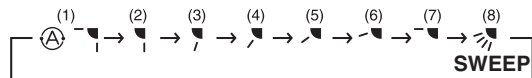

ON TIME/OFF TIME setting buttons



Advance button

Return button

No display: The timer does not operate.

 : The air conditioner starts at the set time.

 : The air conditioner stops at the set time.

   : The air conditioner stops and starts, or starts and stops, at the set times every day. For details, see "SETTING THE TIMER".

CANCEL button

SENSOR button

When you press this button (use a small-tipped object such as a ballpoint pen), the  mark will appear at the display. And the room temperature is detected by the sensor which is built into the indoor unit and the air conditioner is controlled accordingly.

NOTE

If the remote controller is located near a heat source, such as a space heater or in direct sunlight, press the SENSOR button to switch to the sensor on the indoor unit.

ADDRESS switch

- The address switch changes to prevent mixing of signals from remote controller's when two air conditioners are installed next to each other. Normally, the address switch is set to A. For more information, please contact the dealer where you made the purchase.
- Normally, the tabs on the remote controller should not be bent.

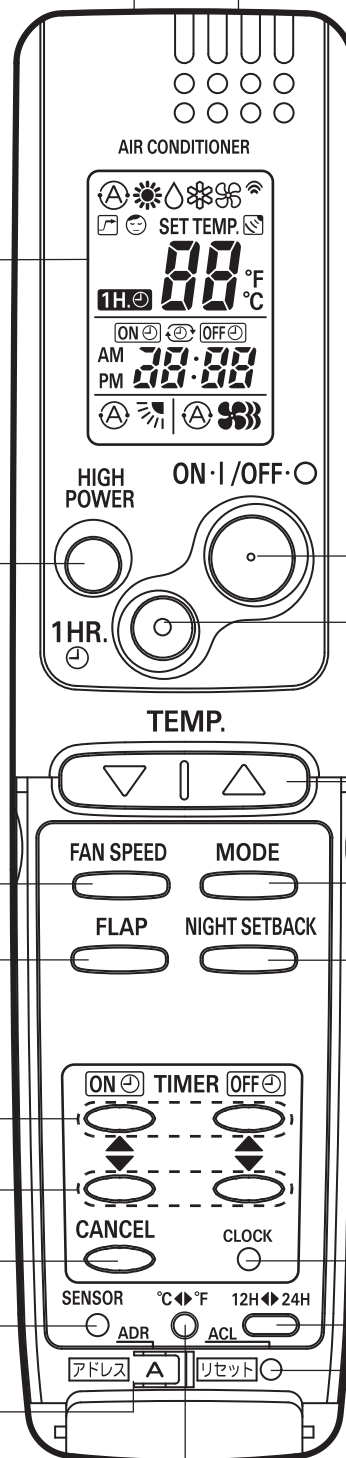

Temperature display selector button

This switches the temperature display between °C and °F.

Sensor

A temperature sensor inside the remote controller senses the room temperature.

ON/OFF operation button

This button is for turning the air conditioner on and off.

1 HR. TIMER button (1-HOUR OFF TIMER)

1H. ☉ : When you press this button, regardless of whether the unit is operating or stopping, the unit operates for one hour and then shuts down.

Temperature setting buttons (TEMP.)

Press the  button to increase the set temperature.

Press the  button to reduce the set temperature.

The temperature setting changes by 1 °C or 2 °F each time one of the TEMP. buttons is pressed.

MODE selector button

Use this button to select AUTO, HEAT, DRY, COOL or FAN mode.

(AUTO) ☉ : When this setting is selected, the air conditioner calculates the difference between the thermostat setting and the room temperature and automatically switches to the “COOL” or “HEAT” mode as appropriate except at “M” of the S/M switch.

(HEAT) ☀ : The air conditioner makes the room warmer.

(DRY) ☹ : The air conditioner reduces the humidity in the room.

(COOL) ❄ : The air conditioner makes the room cooler.

(FAN) 🌀 : The air conditioner works only as a circulation fan except at “M” of the S/M switch.

NIGHT SETBACK button

For details, see “5. Night Setback Mode”. When you press this button in the HEAT, DRY or COOL mode, the ☺ mark appears in the display, and the remote controller will automatically adjust the set temperature to save energy.

CLOCK button

Time display selector button

This switches the time display between 24-hour time and 12-hour time.

ACL button (ALL CLEAR)

Puts the remote controller into pre-operation status. Always press this button after replacing the batteries and setting the S/M switch.

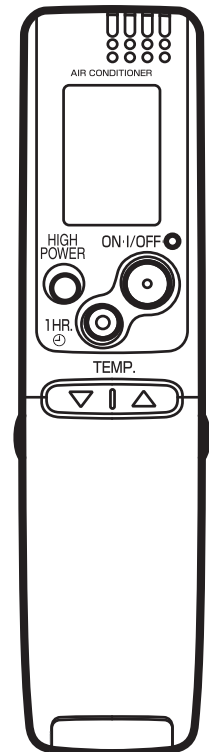

(Cover closed)

NOTE

- The illustration above pictures the remote controller after the cover has been opened.
- The remote controller sends the temperature signal to the air conditioner regularly at five minute intervals. If the signal from the remote controller stops for more than 15 minutes due to the loss of the remote controller or other trouble, the air conditioner will switch to the temperature sensor which is built into the indoor unit and control the room temperature. In these cases, the temperature around the remote controller may differ from the temperature detected at the air conditioner’s position.
- The indoor fan runs continuously when the system is in normal operation. It does not turn off when the desired room temperature is reached. If Night Set Back mode is selected, the fan will turn off intermittently during cooling operation in order to control air flow.

USING THE REMOTE CONTROLLER

HOW TO INSTALL BATTERIES

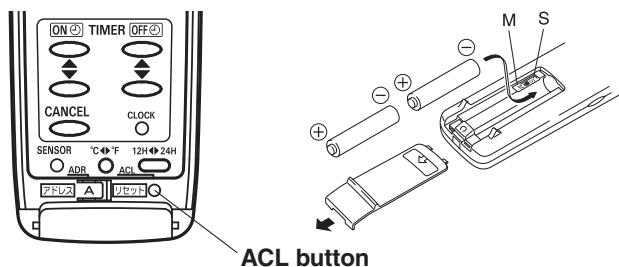

1. Slide the cover in the direction indicated by the arrow and remove it.
2. Install two AAA alkaline batteries. Make sure the batteries point in the direction marked in the battery compartment.
3. Use a thin object such as the tip of a pen to press the ACL button.



CAUTION

- The batteries last about six months, depending on how much you use the remote controller. Replace the batteries when the remote controller's display fails to light, or when the remote controller cannot be used to change the air conditioner's settings.
- Use two fresh leak-proof type-AAA alkaline batteries.
- In replacing batteries, follow the instructions as mentioned in the subsection "HOW TO INSTALL BATTERIES".
- If you do not use the remote controller more than 1 month, take out the batteries.
- Dispose of the used batteries at the designated location in compliance with the applicable local ordinances.

Information for Users on Collection and Disposal of Old Equipment and used Batteries



[Information on Disposal in other Countries outside the European Union]

These symbols are only valid in the European Union. If you wish to discard these items, please contact your local authorities or dealer and ask for the correct method of disposal.



Note for the battery symbol (bottom two symbol examples):

This symbol might be used in combination with a chemical symbol. In this case it complies with the requirement set by the Directive for the chemical involved.



Pb

S/M (Single/Multiple switch)

- Initially, the S/M switch is set to S (Single).
- Set this switch to M (Multiple) for multiple operation.
- Always press ACL button by a thin object such as the tip of a pen after setting the S/M switch.

NOTE

When multiple indoor units are used and units in other rooms are already operating, they will be operating with the same mode as the operating indoor units.

HOW TO USE THE REMOTE CONTROLLER

When using the remote controller, always point the unit's transmitter head directly at the air conditioner's receiver.

Air Conditioner (Indoor unit)

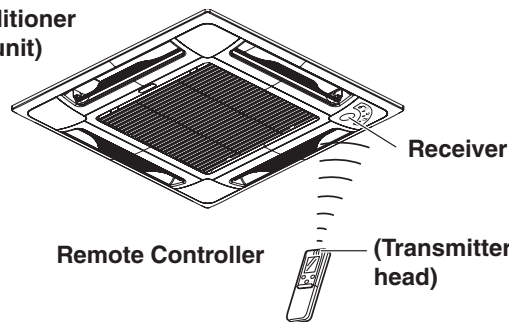

REMOTE CONTROLLER INSTALLATION POSITION

The remote controller may be operated either from a non-fixed position or from a wall-mounted position. To ensure that the air conditioner operates correctly, do not install the remote controller in the following places:

- In direct sunlight
- Behind a curtain or other places where it is covered
- More than 26 ft. (8 m) away from the air conditioner
- In the path of the air conditioner's airstream
- Where it may become extremely hot or cold
- Where it may be subject to electrical or magnetic noise
- Where there is an obstacle between the remote controller and air conditioner (since a check signal is sent from the remote controller every 5 minutes)

MOUNTING THE REMOTE CONTROLLER

Before mounting the remote controller, press the ON/OFF operation button at the mounting location to make sure that the air conditioner operates from that location. The indoor unit should make a beeping sound to indicate that it has received the signal.

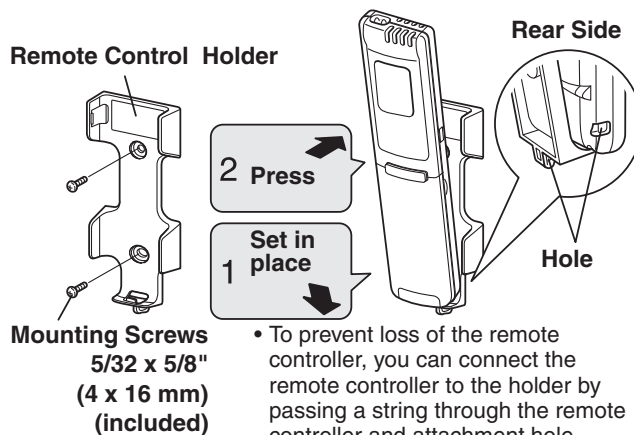

To take out the remote controller, pull it forward.

WHEN HOLDING THE REMOTE CONTROLLER

- When using the remote controller and during air conditioner operation, the transmitter on the remote controller should be pointed towards the receiver on the indoor unit.
- Make sure that there are no objects between the remote controller and receiver which could block the signal.

OPERATION WITH THE REMOTE CONTROLLER

1. Automatic Operation

When the remote controller's S/M switch is at the "S" (Single) position

This unit automatically switches between cooling operation and heating operation according to the difference between the room temperature and the temperature setting.

When the remote controller's S/M switch is at the "M" (Multiple) position

Unlike when the switch is at the "S" position as described above, the function for automatically switching between cooling and heating does not work. Then, the air conditioner calculates the difference between the thermostat setting and room temperature, and automatically determines the mode to operate under cooling or heating. Then, the air conditioner continuously operates under the mode selected at initial operation.

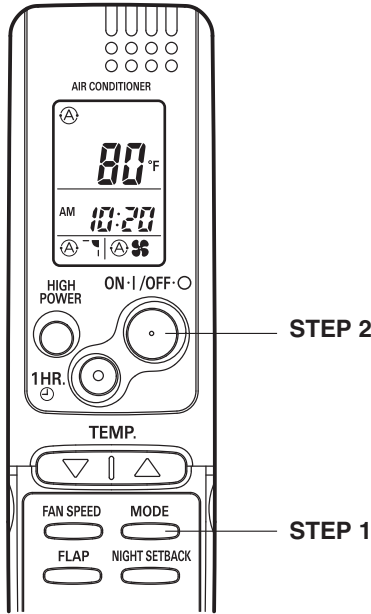

NOTE Check that the circuit breaker on the power panel is turned on.

Once (A) mode is selected and the unit is preset by following the steps below, you can have the air conditioner automatically bring the room to the desired temperature simply by pressing the ON/OFF operation button.

STEP 1	Press the MODE selector button to (A).
STEP 2	Press the ON/OFF operation button.

To stop the air conditioner, press the ON/OFF operation button again.

NOTE • To change the temperature setting; press the temperature setting buttons and change the setting to the desired temperature.

2. Manual Operation

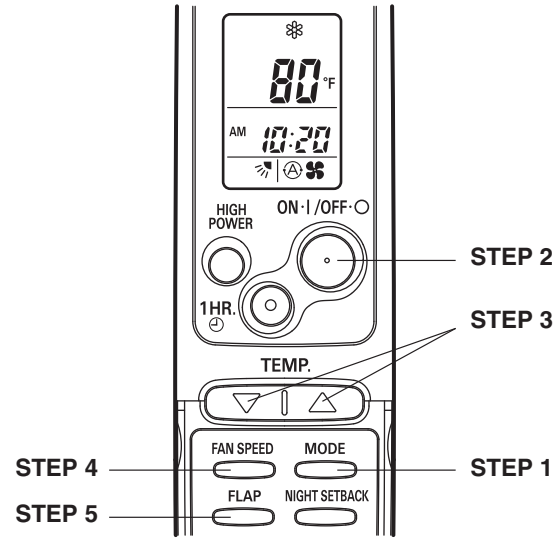

NOTE Check that the circuit breaker on the power panel is turned on.

If the automatic operation settings of the unit do not meet your needs, press the setting buttons as described below and change the settings as desired.

STEP 1	Press the MODE selector button and select the desired mode. For heating operation → ☀ For dehumidifying operation → 💧 For cooling operation → ❄️ For fan only operation → 🌀 (No FAN mode at M of the S/M switch on the remote controller.)
STEP 2	To start the air conditioner, press the ON/OFF operation button.
STEP 3	Press the TEMP. setting buttons to change the temperature setting to the desired temperature. Adjustable temperature range: 30 °C max. or 86 °F max. 16 °C min. 60 °F min.
STEP 4	Set the FAN SPEED selector button to the setting you want.
STEP 5	Press the FLAP button and set the airflow direction as desired. (Refer to "ADJUSTING THE AIRFLOW DIRECTION" on page 13.)

To stop the air conditioner, press the ON/OFF operation button again.

NOTE • Choose the best position in the room for the remote controller, which also acts as the sensor for room comfort and transmits the operating instructions. Once you've found this best position, always keep the remote controller there.
• This appliance has a built-in 5-minute time delay circuit to ensure reliable operation. When the operation button is pressed, the compressor will start running within three minutes. In the event of power failure, the unit will stop.

EG

3. Adjusting the Fan Speed

A. Automatic fan speed

Simply set the FAN SPEED selector button to the position.

This automatically sets the best fan speed for the room temperature.

B. Manual fan speed

If you want to adjust fan speed manually during operation, just set the FAN SPEED selector button as desired. [, , or]

4. Fan Only

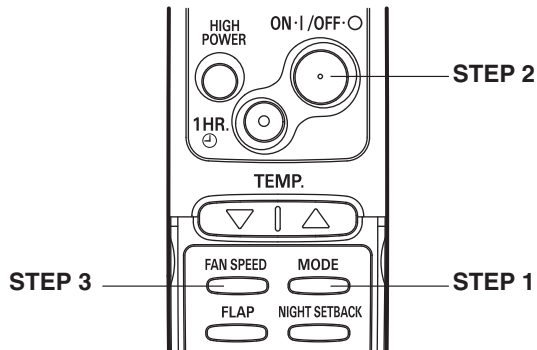

If you want to circulate air without any temperature control, follow these steps:

STEP 1	Press the MODE selector button to switch to the fan mode .
STEP 2	Press the ON/OFF operation button.
STEP 3	Press the FAN SPEED selector button to select the fan speed of your choice (, , or).

NOTE

- There is no FAN only function at M of the S/M switch on the remote controller.

5. Night Setback Mode

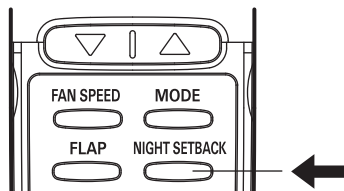
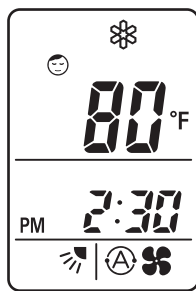

Night Setback Mode is used for saving energy.

Press the NIGHT SETBACK button while unit is operating. The mark appears in the display.

To release the night setback function, press the NIGHT SETBACK button again.

A. In Cooling and DRY Mode: (and)

When the night setback mode is selected, the air conditioner automatically raises the temperature setting 2 °F when 30 minutes have passed after the selection was made, and then another 2 °F after another 30 minutes have passed, regardless of the indoor temperature when night setback was selected. This enables you to save energy without sacrificing comfort. This function is convenient when gentle cooling is needed.

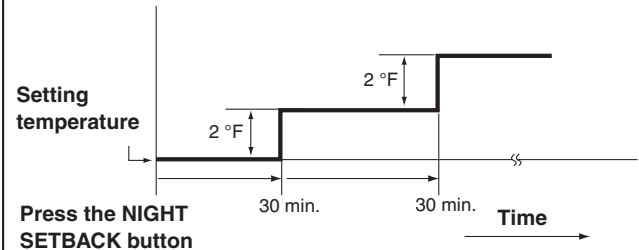

B. In Heating Mode: ()

When the night setback mode is selected, the air conditioner automatically lowers the temperature setting 4 °F when 30 minutes have passed after the selection was made, and then another 4 °F after another 30 minutes have passed, regardless of the indoor temperature when night setback was selected. This enables you to save energy without sacrificing comfort. This function is convenient when gentle heating is needed.

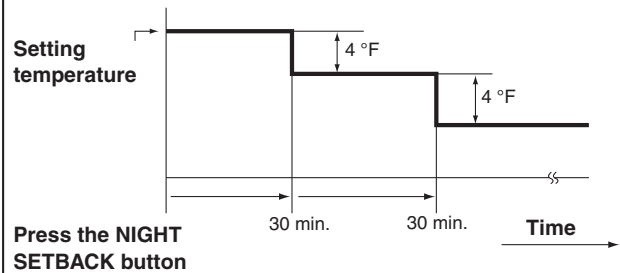

6. HIGH POWER Mode

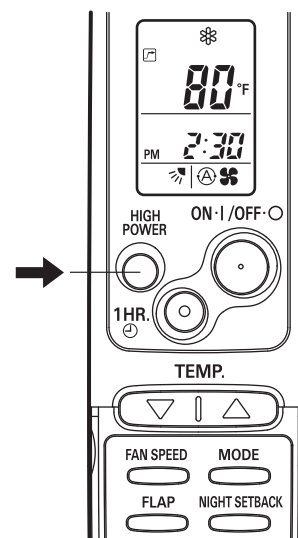

HIGH POWER mode can be used to increase the output of the indoor unit for all operation modes except automatic operation.

Press the HIGH POWER button while unit is operating. The mark appears in the display.

To cancel, press HIGH POWER button again.

- When the HIGH POWER button is pressed, the unit operates at maximum output for 30 minutes, regardless of the desired temperature. The fan speed is 1 step above “High”.
- HIGH POWER Mode cannot be used when the operation mode is in Automatic Operation.

NOTE

- When set to High fan speed during heating operation, the fan runs at High fan speed even though the  mark is displayed.
- Depending on the operating conditions, the fan speed may be increased by a small amount only.

SPECIAL REMARKS

“DRY” () Operation

How it works?

- Once the room temperature reaches the level that was set, the unit’s operation frequency is changed automatically.
- During DRY operation, the fan speed automatically runs at lower speed for providing a comfortable breeze.
- “DRY” operation is not possible if the indoor temperature is 59 °F or less.

Heating () Operation

Heating performance

- Because this air conditioner heats a room by drawing in the heat of the outside air (heat pump system), the heating efficiency will fall off when the outdoor temperature is very low. If sufficient heat cannot be obtained with this air conditioner, use another heating appliance together with it.

Defrosting

- When the outdoor temperature is low, frost or ice may form on the heat exchanger coil, reducing heating performance. When this happens, a microcomputer defrosting system operates. At the same time, the fan on the indoor unit stops and the OPERATION lamp lights red and orange alternately until defrosting is completed. Heating operation restarts after several minutes. (This interval will vary slightly depending upon the outdoor temperature and the way in which frost forms.)

Cold draft prevention

- For several minutes after the start of heating operation, the indoor fan runs at a lower speed until the indoor heat exchanger coil has warmed up sufficiently. However, the fan may remain stopped when the room temperature is low. This is because the COLD DRAFT PREVENTION SYSTEM is in operation.

Cooling () operation

- Sometimes the indoor unit may not get to the set fan speed such as LOW under cool operation at very low outdoor temperatures due to the indoor unit being protected from ice or frost.

Power failure during operation

- In the event of power failure, the unit will stop. When the power is resumed, the unit will restart automatically in approximately 5 minutes, or 15 minutes at M position of the S/M switch on AUTO mode by the remote controller.

Clicking Sound

Clicking sound is heard from the air conditioner

- In heating or cooling operation, any plastic parts may expand or shrink due to a sudden temperature change. In this event, a clicking sound may occur. This is normal, and the sound will soon disappear.

Remote Controller

- The remote controller sends the setting condition to the air conditioner regularly at five minute intervals.

SETTING THE TIMER

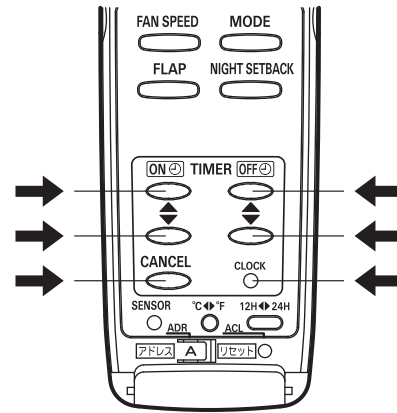

NOTE

In the descriptions below, the following settings are used for the temperature and time indicator selector button on the bottom front section of the remote controller.

- Temperature: °F
- Time: AM, PM

1. How to set the present time

(Example) To set to 10:30 pm.

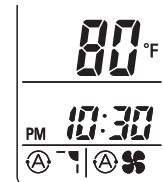
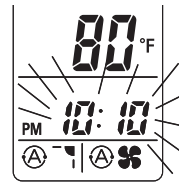

Operation	Indication
1. Press the CLOCK button once if the time indicator is not flashing.	The time indication alone flashes.
2. Press the Advance, Return (▲, ▼) button until PM 10:30 is displayed.	The time can be set in 1-minute increments. Holding down the button advances the time rapidly in 10-minute increments.
3. Press the CLOCK button again.	This completes the setting of the current time.

2. How to set the OFF time

(Example) To stop the air conditioner at 11:00 am.

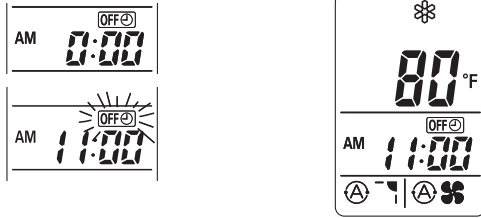

Operation	Indication
1. Press the OFF TIME setting button once.	The timer OFF indication is displayed, and the present OFF time is shown.
2. Press the Advance, Return (▲ , ▼) button until AM 11:00 is displayed.	The timer OFF indication blinks. The time can be set in 10-minute increments. Holding down the button advances the time rapidly in 10-minute increments.
3. Wait a few seconds, and then the setting is complete.	The timer OFF indication stops blinking and the present time is displayed.

3. How to set the ON time

(Example) To start operation at 7:10 am.

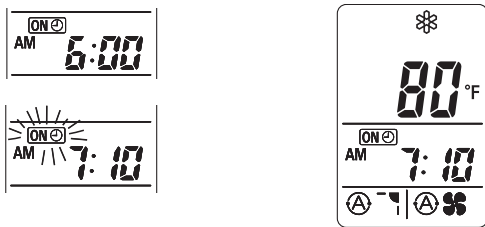

Operation	Indication
1. Press the ON TIME setting button once.	The timer ON indication is displayed, and the present ON time is shown.
2. Press the Advance, Return (▲ , ▼) button until AM 7:10 is displayed.	The timer ON indication blinks. The time can be set in 10-minute increments. Holding down the button advances the time rapidly in 10-minute increments.
3. Wait a few seconds, and then the setting is complete.	The timer ON indication stops blinking and the present time is displayed.

4. How to set daily ON/OFF repeat timer

(Example) To start operation at 7:10 am. and stop the air conditioner at 11:00 am.

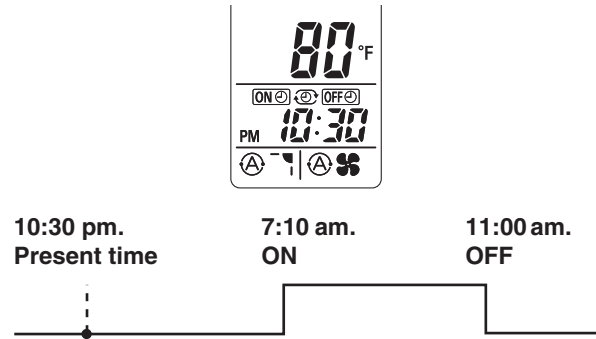

Operation	Indication
1. Set the timer ON/OFF times as shown in 2-1, 2, 3 and 3-1, 2, 3.	The present time 10:30 pm. and ON OFF are displayed.

NOTE

- The ON/OFF combination timer uses the current time as the reference, and it is activated starting from whichever set time comes first.
- With the ON/OFF combination timer, the settings are repeated every day.
- You can check the timer ON/OFF times after you have set them by pressing the ON TIME and OFF TIME setting buttons.

To cancel a timer program

- Press the CANCEL button.
- When either an ON or OFF timer is to be canceled, press the button corresponding to the timer whose program is to be canceled, and then press the CANCEL button.

NOTE

- The airflow direction, fan speed and temperature setting can be changed after a timer program has been set even when the unit is stopped. Even when operation is stopped during an ON timer program, the unit will start operating when the set time is reached provided that the program is not canceled.
- When the ON timer and OFF timer are set to the same time, the timer operates as if it is turned off.

USING THE 1-HOUR OFF TIMER

1. 1-Hour OFF Timer

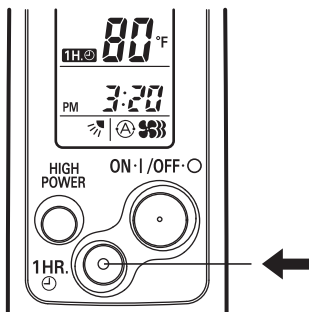

This function causes the unit to operate for one hour and then stop, regardless of whether the unit is on or off when this button is pressed.

The **1HR.** indicator in the display indicates that this function is operating.

Setting procedure:

Regardless of whether the unit is operating or stopped, press the 1 HR. TIMER button.

1HR. appears in the display.

Cancellation procedure:

Press the ON/OFF operation button to turn the unit off, wait for the unit to stop operating, and then press the ON/OFF operation button again.

The 1-Hour Timer function is now cancelled and the unit operates normally.

NOTE

- If, while the 1-Hour Timer function is operating, the 1HR. TIMER button is pressed once to cancel the function and then again, the unit continues to operate for one hour from that point in time and then stops.
- It is not possible to use the OFF Timer and 1-Hour OFF Timer together. Whichever function is set last takes precedence. If the 1 HR. TIMER button is pressed while the TIMER OFF function operates, the OFF Timer is cancelled and the unit will stop operating one hour later.

2. Operation together with the daily ON/OFF repeat timer

The 1-Hour OFF Timer setting is given priority over the DAILY ON/OFF REPEAT setting.

TIPS FOR ENERGY SAVING

Avoid

- Do not block neither the air intake nor the air outlet. It may cause less performance, and may leads to malfunctions.
- Do not let direct sunlight into the room. Use sunshades, blinds or curtains. If the walls and ceiling of the room are warmed by the sun, it will take longer to cool the room.

Do

- Always try to keep the air filter clean. (Refer to "CARE AND CLEANING".) A clogged filter will impair the performance of the unit.
- To prevent conditioned air from escaping, keep windows, doors and any other openings closed.

ADJUSTING THE AIRFLOW DIRECTION

The vertical airflow can be adjusted by moving the flap with the remote controller. Do not move the flap with your hands. Confirm that the remote controller has been turned on. Use the FLAP button to set either the sweep function or one of the six airflow direction settings.

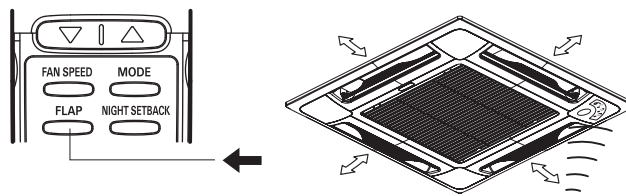

A. Sweep function



The flap starts moving up and down to deliver air over the sweep range.

B. Setting the airflow manually



Referring to the above illustration, use the FLAP button to set the airflow direction within the range used during the heating, cooling, or dehumidifying operation.

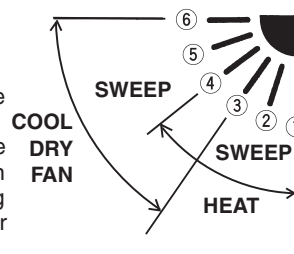

C. Auto flap function



The flap is set to the recommended position.

NOTE

- The flap automatically closes when the unit is off.
- During the heating operation, the fan speed will be very low and the flap will be in the horizontal position (position ⑥) until the air being blown out of the unit begins to warm. Once the air warms up, the flap position and fan speed change to the settings specified with the remote controller.



CAUTION

- Use the FLAP button on the remote controller to adjust the position of the flap. If you move the flap by hand, the flap position according to the remote controller and the actual flap position may no longer match. If this should happen, shut off the unit, wait for the flap to close, and then turn on the unit again; the flap position will now be normal again.
- Do not have the flap pointed down during cooling operation. Condensation may begin to form around the air vent and drip down.

OPERATION WITHOUT THE REMOTE CONTROLLER

INDOOR UNIT

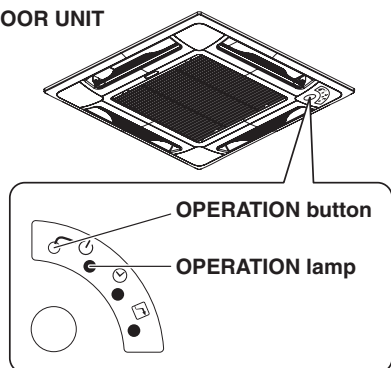

If you have lost the remote controller or it has trouble, follow the steps below.

When the air conditioner is not running

Each time the OPERATION button is pressed, the type of operation conducted is indicated by the changing color of the OPERATION lamp. Press the button and select the lamp color that suits your preference for operation.

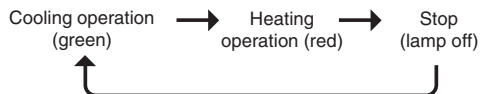

NOTE

The temperature is set to the room temperature minus 4°F during the cooling operation and to the room temperature plus 4°F during the heating operation, and the fan speed and flap are set to Auto.

CARE AND CLEANING



WARNING

- Cleaning and maintenance operations must be carried out by specially trained personnel. While working in high places, slipping or falling may result in serious injury.
- For safety, be sure to turn the air conditioner off and also to disconnect the power before cleaning.
- Do not pour water on the indoor unit to clean it. This will damage the internal components and cause an electric shock hazard.

Ceiling panel (Indoor Unit)

Clean the ceiling panel of the indoor unit with a vacuum cleaner brush, or wipe it with a clean, soft cloth.

If it is stained, use a clean cloth moistened with a mild liquid detergent. When cleaning it, be careful not to force the flaps out of place.



CAUTION

- Never use solvents, or harsh chemicals when cleaning the indoor unit. Do not wipe the plastic casing using very hot water.
- Some metal edges and the fins are sharp and may cause injury if handled improperly; be especially careful when you clean these parts.
- The internal coil and other components of the outdoor unit must be cleaned every year. Consult your dealer or service center.

Cleaning the flaps

- The air outlet flap can be removed and washed with water.
- Be sure to always stop operation before removing the flap.
- After washing with water, allow it to dry, and then remount it.

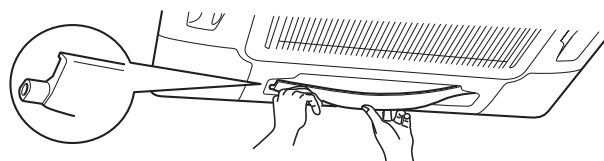

CAUTION

- Do not move the flap with your hands.
- When using a footstool or the like, be careful not to let it tip over.

Cleaning the main unit and Remote Controller

- Wipe clean using a soft, dry cloth.
- To remove stubborn dirt, moisten a cloth in warm water no hotter than 104 °F, wring thoroughly, and then wipe.

Air filter

The air filter collects dust and other particles from the air and should be cleaned once every 6 months.

If the filter gets blocked, the efficiency of the air conditioner drops greatly.

NOTE

The frequency with which the filter should be cleaned depends on the environment in which the unit is used.

How to remove the filter

1. Slide the two latches of the air intake grille with your thumbs in the direction of the arrow to open the grille.

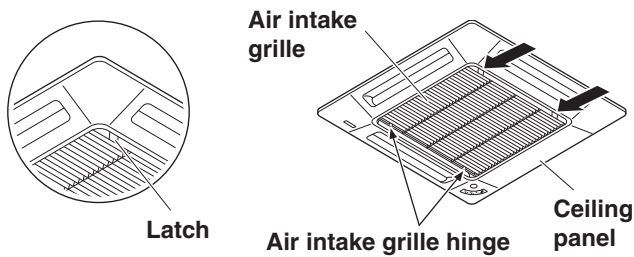

2. Open the air intake grille downward.



3. Press the tabs on both sides of the air filter (indicated with ◁ marks on the grill) to release the filter, and then, lift and pull the filter up and out using the tabs to remove it.

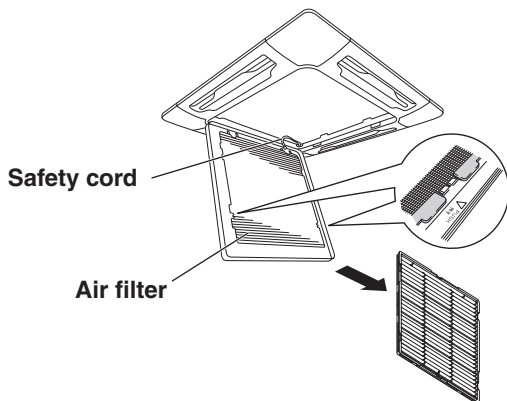

4. Use a vacuum cleaner to remove light dust. If there is sticky dust on the filter, wash the filter in lukewarm, soapy water, rinse it in clean water, and dry it.
5. Insert the filter correctly again inside the grille, close the grille letting the latches slide towards the outside and fix again the latch.

How to remove the air intake grille

1. Open the air intake grille.
2. Detach the safety cord from the frame (remember to attach it again after cleaning or maintenance).
3. Hold on the air intake grille and pull it towards you to detach the two air intake grille hinges.
4. Clean the grille gently using a soft sponge, or the like. Then dry it with care.
Neutral detergent may be used to remove stubborn dirt. Then rinse thoroughly with water and dry it.

Air intake grille hinge

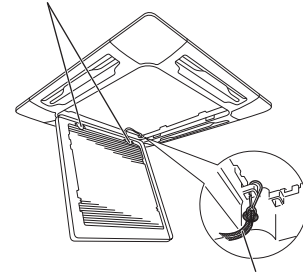

CAUTION

- When cleaning the air filter, never remove the safety cord. If it is necessary to remove it for servicing and maintenance inside, be sure to reinstall the safety cord securely (hook on the grille side) after the work.
- When the air intake grille has been opened, rotating parts (such as the fan), electrically charged areas, etc. will be exposed in the unit's opening. Bear in mind the dangers that these parts and areas pose, and proceed with the work carefully.
- Periodically check the outdoor unit to see if the air outlet or air intake is clogged with dirt or soot.

Care: After a prolonged idle period

Check the indoor and outdoor unit air intakes and outlets for blockage; if there is a blockage, remove it.

Care: Before a prolonged idle period

- Operate the fan for half a day to dry out the inside.
- Disconnect the power supply and also turn off the circuit breaker.
- Clean the air filter and replace it in its original position.
- Outdoor unit internal components must be checked and cleaned periodically.
Contact your local dealer for this service.

TROUBLESHOOTING (BEFORE CALLING FOR SERVICE)

If your air conditioner does not work properly, first check the following points before requesting service. If it still does not work properly, contact your dealer or service center.

Trouble	Possible Cause	Remedy
Air conditioner does not run at all.	<ol style="list-style-type: none"> 1. Power failure. 2. Leakage circuit breaker tripped. 3. Line voltage is too low. 4. Batteries in remote controller have run down. 	<ol style="list-style-type: none"> 1. Restore power. 2. Contact service center. 3. Consult your electrician or dealer. 4. Replace batteries.
OPERATION lamp blinks and air conditioner does not operate.	Trouble in system.	Contact service center.
Compressor runs but soon stops.	Obstruction in front of condenser coil. (Outdoor Unit)	Remove obstruction.
Poor cooling (or heating) performance.	<ol style="list-style-type: none"> 1. Dirty or clogged air filter. 2. Heat source or many people in room. 3. Doors and/or windows are open. 4. Obstacle near air intake or air discharge port. 5. Thermostat is set too high for cooling (or too low for heating). 6. (Outdoor temperature is too low for heating.) 	<ol style="list-style-type: none"> 1. Clean air filter to improve airflow. 2. Eliminate heat source if possible. 3. Shut them to keep the heat (or cold) out. 4. Remove it to ensure good airflow. 5. Set the temperature lower (or higher). 6. (Consult your dealer or try to use another heat appliance.)
Clicking sound is heard from the air conditioner.	In heating or cooling operation, any plastic parts may expand or shrink due to a sudden temperature change. In this event, a clicking sound may occur.	This is normal, and the sound will soon disappear.
OPERATION lamp lights but outdoor unit will not run.	The use of cellular phones near the air conditioner may cause disturbance to its normal operation.	<ol style="list-style-type: none"> 1. Turn off the power then restart the air conditioner after a while. 2. Consult your dealer.
TIMER lamp blinks (3 sec. interval) and air conditioner does not operate.	FLOAT SWITCH is activated.	Contact service center.

OPERATING RANGE

The air conditioner is operable within the temperature ranges as listed below:

	Temperature	Indoor air temperature	Outdoor air temperature
COOLING	Max.	95 °F DB / 71 °F WB	115 °F DB
	Min.	67 °F DB / 57 °F WB	For Single use 0 °F DB For Multiple use 14 °F DB
HEATING	Max.	80 °F DB / 67 °F WB	75 °F DB / 65 °F WB
	Min.	- DB / - WB	- DB / 0 °F WB

WIRED REMOTE CONTROLLER

A separately sold wired remote controller (CZ-RD515U) used with this air conditioner is also available. If you wish to use the wired remote control function, you will need to purchase the optional wired remote controller.

SPECIFICATIONS

• For Single use

Model No.			Outdoor Unit		Indoor Unit		
			CU-KE12NK1		CS-KE12NB41		
Power Source			Single-phase, 115 V, 60 Hz				
Cooling Capacity		kW	3.50 [0.90 ~ 3.50]				
		BTU/h	11,900 [3,000 ~ 11,900]				
Heating Capacity		kW	4.00 [0.90 ~ 4.00]				
		BTU/h	13,600 [3,000 ~ 13,600]				
Operation Sound	Cooling Operation	Outdoor (Hi)	dB(A)	47			
		Indoor(H/M/L)		-			
	Heating Operation	Outdoor (Hi)	dB(A)	49			
		Indoor(H/M/L)		-			
Unit Dimensions (HxWxD)			inch(mm)	21-9/16x28-11/32x10-7/16 (548x720x265)	11-5/32x22-5/8x22-5/8 (283x575x575)		
Net Weight			lbs.(kg)	77.2(35.0)		35.3(16.0)	

• For Single use

Model No.			Outdoor Unit		Indoor Unit		
			CU-KE18NKU		CS-KE18NB4UW		
Power Source			Single-phase, 208-230 V, 60 Hz				
Cooling Capacity		kW	5.15 [1.20 ~ 5.15]				
		BTU/h	17,500 [4,000 ~ 17,500]				
Heating Capacity		kW	6.00 [1.30 ~ 6.00]				
		BTU/h	20,400 [4,400 ~ 20,400]				
Operation Sound	Cooling Operation	Outdoor (Hi)	dB(A)	51			
		Indoor(H/M/L)		-			
	Heating Operation	Outdoor (Hi)	dB(A)	52			
		Indoor(H/M/L)		-			
Unit Dimensions (HxWxD) (Indoor unit : Include panel)			inch(mm)	26-3/8x34-21/32x11-7/32 (670x880x285)	11-5/32x22-5/8x22-5/8 (283x575x575)		
Net Weight			lbs.(kg)	97.0(44.0)		35.3(16.0)	

Model No.		Ceiling Panel	
		CZ-18BT1U	
Unit Dimensions (HxWxD)	inch(mm)	1-9/16x24-19/32x24-19/32 (40x625x625)	
Net Weight	lbs. (kg)	6.0(2.7)	

SPECIFICATIONS (CONTINUED)

• For Multiple use

Model No.		Indoor Unit	
		CS-KE18NB4UW	
Power Source		Single-phase, 208-230 V, 60 Hz	
Cooling Capacity	kW	5.15	
	BTU/h	17,500	
Heating Capacity	kW	6.00	
	BTU/h	20,400	
Operation Sound	Cooling Operation (H/M/L)	dB(A)	44/40/36
	Heating Operation (H/M/L)	dB(A)	44/40/36
Unit Dimensions (H×W×D)		inch(mm)	11-5/32×22-5/8×22-5/8 (283×575×575)
Net Weight		lbs.(kg)	35.3(16.0)

• For Multiple use

Model No.		Outdoor Unit		
		CU-3KE19NBU	CU-4KE24NBU	CU-4KE31NBU
Power Source		Single-phase, 208-230 V, 60 Hz		
Cooling Capacity	kW	5.45 [2.90 ~ 5.45]	6.80 [2.90 ~ 6.80]	9.00 [2.90 ~ 9.00]
	BTU/h	18,600 [9,800 ~ 18,600]	23,200 [9,800 ~ 23,200]	30,600 [9,800 ~ 30,600]
Heating Capacity	kW	7.30 [3.40 ~ 7.30]	8.60 [3.40 ~ 8.60]	9.40 [3.40 ~ 9.40]
	BTU/h	24,800 [11,600 ~ 24,800]	29,200 [11,600 ~ 29,200]	32,000 [11,600 ~ 32,000]
Operation Sound	Cooling Operation (Hi)	dB(A)	50	53
	Heating Operation (Hi)	dB(A)	52	52
Unit Dimensions (H×W×D)		inch(mm)	29-1/8×35-7/16×12-19/32 (740×900×320)	35-1/32×35-7/16×12-19/32 (890×900×320)
Net Weight		lbs.(kg)	143.3(65.0)	180.8(82.0)

APPENDIX B INSTALLATION INSTRUCTIONS

CS-KE12NB41 & CZ-18BT1U + CU-KE12NK1
CS-KE18NB4UW & CZ-18BT1U + CU-KE18NKU

(852-6-4190-577-00-2)

INSTALLATION INSTRUCTIONS

Split System Air Conditioner

This air conditioner uses the refrigerant R410A.

Contents

NOTE External diameter of service port R410A: 5/16"

Page

Model Combinations

Combine indoor and outdoor units only as listed below.

Model No.

<u>Indoor Unit</u>	—————	<u>Outdoor Unit</u>
CS-KE12NB41		CU-KE12NK1

Power Source:
60 Hz, single-phase, 115 V

CS-KE18NB4UW	—————	CU-KE18NKU
--------------	-------	------------

Power Source:
60 Hz, single-phase, 230/208 V

Ceiling Panel

CZ-18BT1U

IMPORTANT!

Please Read Before Starting 2

1. GENERAL

- 1-1. Tools Required for Installation (not supplied)
- 1-2. Accessories Supplied with Unit
- 1-3. Optional Copper Tubing Kit
- 1-4. Type of Copper Tube and Insulation Material
- 1-5. Additional Materials Required for Installation

2. INSTALLATION SITE SELECTION

- 2-1. Indoor Unit
- 2-2. Outdoor Unit

3. HOW TO INSTALL THE INDOOR UNIT

- 3-1. Preparation for Suspending
- 3-2. Suspending the Indoor Unit
- 3-3. Placing the Unit Inside the Ceiling
- 3-4. Installing the Drain Piping
- 3-5. Checking the Drainage
- 3-6. How to Install the Ceiling Panel
- 3-7. Wiring Instructions
- 3-8. Recommended Wire Length and Diameter
- 3-9. Wiring Instructions for Inter-unit Connections

4. HOW TO INSTALL THE OUTDOOR UNIT

- 4-1. Wiring Instructions for the Outdoor Unit

5. REFRIGERANT TUBING

- 5-1. Use of the Flaring Method
- 5-2. Flaring Procedure with a Flare Tool
- 5-3. Caution before Connecting Tubes Tightly
- 5-4. Connecting Tubing between Indoor and Outdoor Units
- 5-5. Insulation of Refrigerant Tubing
- 5-6. Taping the Tubes
- 5-7. Finishing the Installation

6. AIR PURGING

- Air Purging with a Vacuum Pump (for Test Run)
- Basic Functions of the Service Valves
- Pump Down
- Service Valve Connections

7. REMOTE CONTROLLER INSTALLATION POSITION

- 7-1. Mounting on a Wall

8. ADDRESS SWITCH

- 8-1. Address Setting of the Remote Controller

IMPORTANT!

Please Read Before Starting

This air conditioning system meets strict safety and operating standards. As the installer or service person, it is an important part of your job to install or service the system so it operates safely and efficiently.

For safe installation and trouble-free operation, you must:

- Carefully read this instruction booklet before beginning.
- Follow each installation or repair step exactly as shown.
- Observe all local, state, and national electrical codes.
- Pay close attention to all warning and caution notices given in this manual.



WARNING

This symbol refers to a hazard or unsafe practice which can result in severe personal injury or death.



CAUTION

This symbol refers to a hazard or unsafe practice which can result in personal injury or product or property damage.

If Necessary, Get Help

These instructions are all you need for most installation sites and maintenance conditions. If you require help for a special problem, contact our sales/service outlet or your certified dealer for additional instructions.

In Case of Improper Installation

The manufacturer shall in no way be responsible for improper installation or maintenance service, including failure to follow the instructions in this document.

SPECIAL PRECAUTIONS

WARNING

When Wiring



ELECTRICAL SHOCK CAN CAUSE SEVERE PERSONAL INJURY OR DEATH. ONLY A QUALIFIED, EXPERIENCED ELECTRICIAN SHOULD ATTEMPT TO WIRE THIS SYSTEM.

- Do not supply power to the unit until all wiring and tubing are completed or reconnected and checked.
- Highly dangerous electrical voltages are used in this system. Carefully refer to the wiring diagram and these instructions when wiring. Improper connections and inadequate grounding can cause **accidental injury or death**.
- **Ground the unit** following local electrical codes.
- Connect all wiring tightly. Loose wiring may cause overheating at connection points and a possible fire hazard.
- To prevent possible hazards from insulation failure,  the unit must be grounded.

When Transporting

Be careful when picking up and moving the indoor and outdoor units. Get a partner to help, and bend your knees when lifting to reduce strain on your back. Sharp edges or thin aluminum fins on the air conditioner can cut your fingers.

When Installing...

Select an installation location which is rigid and strong enough to support or hold the unit, and select a location for easy maintenance.

...In a Ceiling or Wall

Make sure the ceiling/wall is strong enough to hold the unit's weight. It may be necessary to construct a strong wood or metal frame to provide added support.

...In a Room

Properly insulate any tubing run inside a room to prevent "sweating" that can cause dripping and water damage to walls and floors.



CAUTION

Keep the fire alarm and the air outlet at least 1.5 m away from the unit.

...In Moist or Uneven Locations

Use a raised concrete pad or concrete blocks to provide a solid, level foundation for the outdoor unit. This prevents water damage and abnormal vibration.

...In an Area with High Winds

Securely anchor the outdoor unit down with bolts and a metal frame. Provide a suitable air baffle.

...In a Snowy Area (for Heat Pump-type Systems)

Install the outdoor unit on a raised platform that is higher than drifting snow. Provide snow vents.

When Connecting Refrigerant Tubing



WARNING

- When performing piping work do not mix air except for specified refrigerant (R410A) in refrigeration cycle. It causes capacity down, and risk of explosion and injury due to high tension inside the refrigerant cycle.
- Refrigerant gas leakage may cause fire.
- Do not add or replace refrigerant other than specified type. It may cause product damage, burst and injury etc.
- Ventilate the room well, in the event that refrigerant gas leaks during the installation. Be careful not to allow contact of the refrigerant gas with a flame as this will cause the generation of poisonous gas.



- Use the flare method for connecting tubing.
- Apply refrigerant lubricant to the matching surfaces of the flare and union tubes before connecting them, then tighten the nut with a torque wrench for a leak-free connection.
- Check carefully for leaks before starting the test run.
- Do not leak refrigerant while piping work for an installation or re-installation, and while repairing refrigeration parts. Handle liquid refrigerant carefully as it may cause frost-bite.

When Servicing

- Turn the power OFF at the main power box (mains) before opening the unit to check or repair electrical parts and wiring. 
- Keep your fingers and clothing away from any moving parts.
- Clean up the site after you finish, remembering to check that no metal scraps or bits of wiring have been left inside the unit being serviced.

Others



- Ventilate any enclosed areas when installing or testing the refrigeration system. Escaped refrigerant gas, on contact with fire or heat, can produce dangerously toxic gas.
- Confirm upon completing installation that no refrigerant gas is leaking. If escaped gas comes in contact with a stove, gas water heater, electric room heater or other heat source, it can produce dangerously toxic gas.
- Do not touch the air inlet or the sharp aluminum fins of the outdoor unit. You may get injured. 
- Do not sit or step on the unit, you may fall down accidentally. 
- Do not stick any object into the FAN CASE. You may be injured and the unit may be damaged. 



NOTE

The illustrations are based on the typical appearance of a standard model. Consequently, the shape may differ from that of the air conditioner that you are installing.

1. General













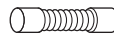

This booklet briefly outlines where and how to install the air conditioning system. Please read over the entire set of instructions for the indoor and outdoor units and make sure all accessory parts listed are with the system before beginning.

1-1. Tools Required for Installation (not supplied)

- | | | |
|------------------------------|------------------------------|----------------------------|
| 1. Standard screwdriver | 6. Sabre saw or key hole saw | 11. Tube cutter |
| 2. Phillips head screwdriver | 7. Hacksaw | 12. Tube flaring tool |
| 3. Knife or wire stripper | 8. Core bits | 13. Torque wrench |
| 4. Tape measure | 9. Hammer | 14. Adjustable wrench |
| 5. Carpenter's level | 10. Drill | 15. Reamer (for deburring) |

1-2. Accessories Supplied with Unit

Table 1

Parts	Figure	Q'ty	Remarks	Parts	Figure	Q'ty	Remarks
Washer		8	For temporarily suspending indoor unit from ceiling	Truss head screw	 3/16 × 13/32" (5 × 10mm)	4	For full-scale installation diagram
Flare insulation	 1/8" (T3) 3/16" (T5)	2 set	For wide / narrow tube connection	Drain hose	 5-1/2" (L140)	1	For unit & PVC tube connection
Insulation tape	 3/32" (T2)	2	For wide / narrow tube / flare nut connection	Hose band		2	For drain hose connection
Vinyl tie		8	For flare / drain insulating connection	Tapping screw	Truss-head Phillips 5/32 × 5/8" (4 × 16mm) 	2	
Drain hose insulation	 13/32" (T10)	1	For drain tube connection	Cushion rubber		4	Packed in the outdoor unit
Remote controller		1		Truss head screw	 5/32 × 15/32" (4 × 12mm)	4	Packed in the ceiling panel
Remote control holder		1		Special screw	 3/16 × 1-9/16" (5 × 40mm)	4	
AAA alkaline battery		2		<ul style="list-style-type: none"> • Use M10 or 3/8" for suspension bolts. • Suspension bolts and nuts (locally purchased) 			
Full-scale installation diagram		1	Printed on container box				

1-3. Optional Copper Tubing Kit

Copper tubing for connecting the outdoor unit to the indoor unit is available in kits which contain the narrow and wide tubing, fittings and insulation. Consult your nearest sales outlet or air conditioning workshop.

1-4. Type of Copper Tube and Insulation Material

If you wish to purchase these materials separately from a local source, you will need:

- Deoxidized annealed copper tube for refrigerant tubing as detailed in Table 2.
Cut each tube to the appropriate lengths 1' to 1'4" (30 cm to 40 cm) to dampen vibration between units.
- Foamed polyethylene insulation for the specified copper tubes as required to precise length of tubing. Wall thickness of the insulation should be not less than 5/16" (8 mm).
- Use insulated copper wire for field wiring. Wire size varies with the total length of wiring. Refer to 3-7. Wiring Instructions for details.

Table 2

Model	Narrow Tube		Wide Tube	
	Outer Dia.	Thickness	Outer Dia.	Thickness
CS-KE12NB41	1/4" (6.35 mm)	0.0314" (0.8 mm)	3/8" (9.52 mm)	0.0314" (0.8 mm)
CS-KE18NB4UW	1/4" (6.35 mm)	0.0314" (0.8 mm)	1/2" (12.70 mm)	0.0314" (0.8 mm)



CAUTION

Check local electrical codes and regulations before obtaining wire. Also, check any specified instructions or limitations.

1-5. Additional Materials Required for Installation

1. Refrigeration (armored) tape
2. Insulated staples or clamps for connecting wire
(See local codes)
3. Putty
4. Refrigeration lubricant
5. Clamps or saddles to secure refrigerant tubing

2. Installation Site Selection

2-1. Indoor Unit



WARNING

To prevent abnormal heat generation and the possibility of fire, do not place obstacles, enclosures and grilles in front of or surrounding the air conditioner in a way that may block air flow.

AVOID:

- direct sunlight.
- nearby heat sources that may affect performance of the unit.
- areas where leakage of flammable gas may be expected.
- places where large amounts of oil mist exist.

DO:

- select an appropriate position from which every corner of the room can be uniformly cooled.
- select a location that will hold the weight of the unit.
- select a location where tubing and drain hose have the shortest run to the outside.
- allow room for operation and maintenance as well as unrestricted air flow around the unit. (Fig. 1)
- install the unit within the maximum elevation difference (H) above or below the outdoor unit and within a total tubing length (L) from the outdoor unit as detailed in Table 3 and Fig. 2.
- install the indoor unit more than 3.3' (1 m) away from any antenna or power lines or connecting wires used for television, radio, telephone, security system, or intercom. Electrical noise from any of these sources may affect operation.

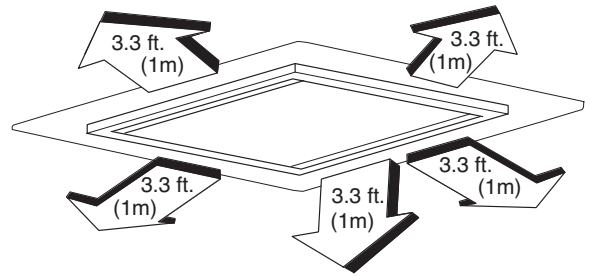

Fig. 1

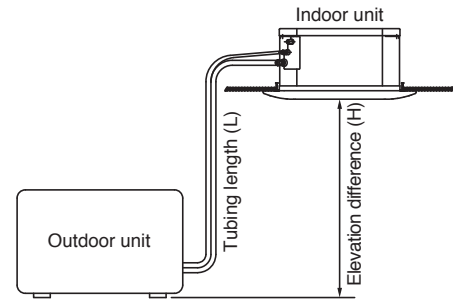

Fig. 2



CAUTION

Air delivery will be degraded if the distance from the floor to the ceiling is greater than 10 ft. (3 m).

Table 3

Model	Max. Allowable Tubing Length at Shipment (ft.)	Limit of Tubing Length (L) (ft.)	Limit of Elevation Difference (H) (ft.)	Required Amount of Additional Refrigerant (oz./ft.)*
CS-KE12NB41	25	65	23	0.16
CS-KE18NB4UW	25	100	50	0.27

* If total tubing length becomes 25 to 65 ft. (Max.) or 25 to 100 ft. (Max.), charge additional refrigerant (R410A) by 0.16 or 0.27 oz./ft. No additional charge of compressor oil is necessary. For more detailed charging information, refer to the Technical & Service Manual.

2-2. Outdoor Unit

AVOID:

- heat sources, exhaust fans, etc. (Fig. 3)
- damp, humid or uneven locations.

DO:

- choose a place as cool as possible.
- choose a place that is well ventilated.
- install in a location where at least two sides are unobstructed, so that the flow of air at the intake port or exhaust port is not blocked, and so that sufficient space is ensured for maintenance to be carried out without trouble. In general the top also must be unobstructed. (Figs. 4a and 4b)
- provide a solid base (level concrete pad, concrete block, 4" × 1'4" (10 × 40 cm) beams or equal), a minimum of 4" (10 cm) above ground level to reduce humidity and protect the unit against possible water damage and decreased service life. (Figs. 5a and 5b)



CAUTION

A solid base must not cover the hole of the bottom plate.

- install cushion rubber under unit's feet to reduce vibration and noise. (Fig. 5c)
- use lug bolts or equal to bolt down unit, reducing vibration and noise.
- install in a location where no antenna of a television or radio exists within 10' (3 m).

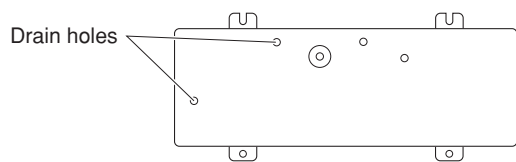

Fig. 5a

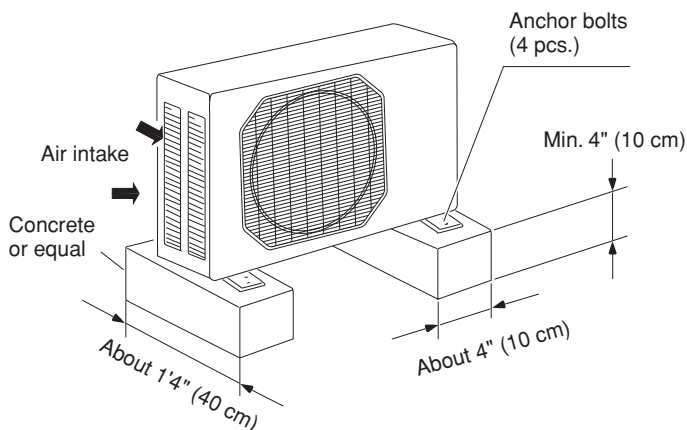

Fig. 5b

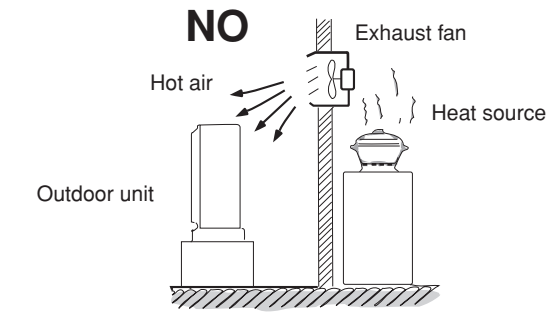

Fig. 3

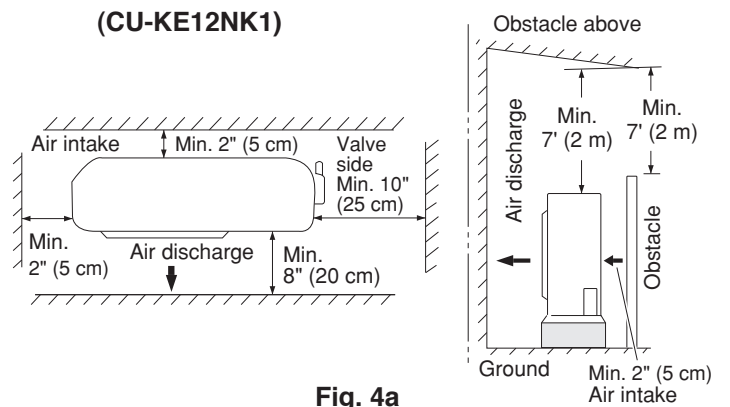

Fig. 4a

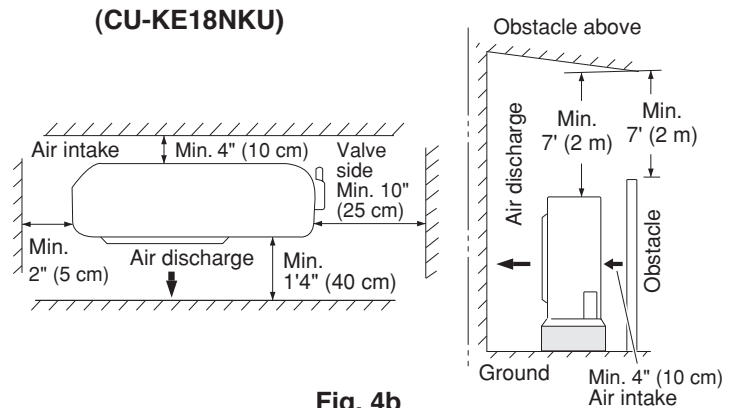

Fig. 4b

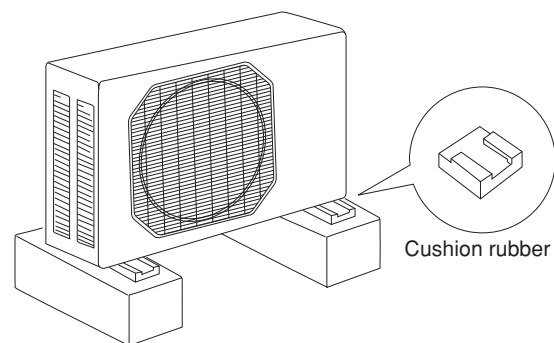

Fig. 5c

3. How to Install the Indoor Unit

3-1. Preparation for Suspending

This unit uses a drain pump. Use a carpenter's level to check that the unit is level.

3-2. Suspending the Indoor Unit

(1) Fix the suspension bolts securely in the ceiling using the method shown in the diagrams, by attaching them to the ceiling support structure, or by any other method that ensures that the unit will be securely and safely suspended. (Fig. 6-1)

(2) Follow the diagram to make the holes in the ceiling.

(3) Determine the pitch of the suspension bolts using the supplied full-scale installation diagram. The diagram shows the relationship between the positions of the suspension fitting, unit, and panel. (Fig. 6-2)

3-3. Placing the Unit Inside the Ceiling

(1) Be sure to remove the fan protection (4pcs) for transportation before hanging up the indoor unit.

(2) When placing the unit inside the ceiling, determine the pitch of the suspension bolts using the supplied full-scale installation diagram. (Fig. 6-3)

Tubing and wiring must be laid inside the ceiling when suspending the unit. If the ceiling is already constructed, lay the tubing and wiring into position for connection to the unit before placing the unit inside the ceiling.

(3) The length of suspension bolts must be appropriate for a distance between the bottom of the bolt and the bottom of the unit of more than 19/32" (15 mm) as shown in the diagram. (Fig. 6-3)

(4) Thread the 3 hexagonal nuts (locally purchased) and 2 supplied washers onto each of the 4 suspension bolts as shown in the diagram. Use 1 nut and 1 washer for the upper side, and 2 nuts and 1 washer for the lower side, so that the unit will not fall off the suspension lugs. (Fig. 6-4)

(5) Adjust so that the distance between the unit and the ceiling bottom is 1/2" (13 mm) to 23/32" (18 mm). Tighten the nuts on the upper side and lower side of the suspension lug. (Fig. 6-4)

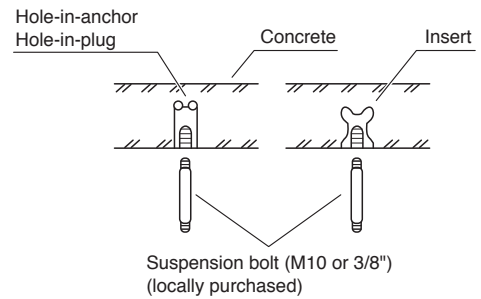

Fig. 6-1

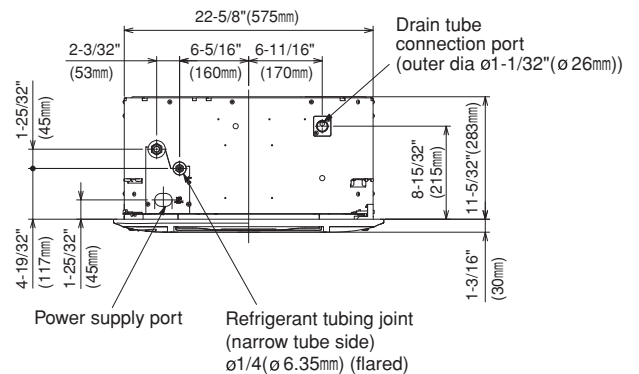
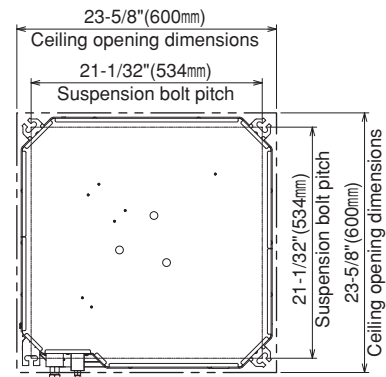

Fig. 6-3

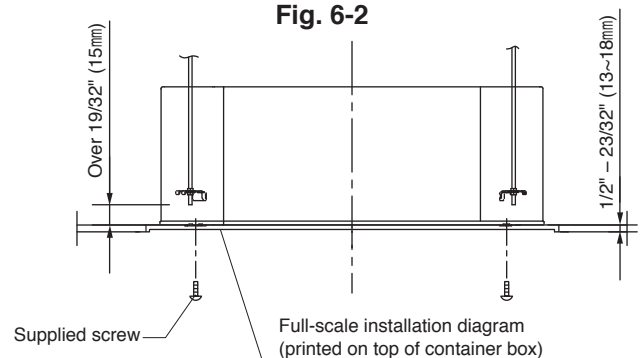

Fig. 6-3

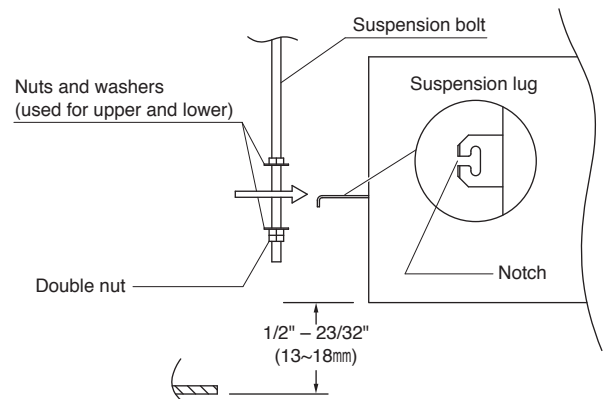

Fig. 6-4

3-4. Installing the Drain Piping

- (1) Prepare standard hard PVC pipe (locally purchased O.D. 1-1/32" (26 mm)) for the drain and use the supplied hose band to prevent water leaks. (Fig. 6-5)
- (2) To install the drain hose, first place 1 of the 2 hose bands over the unit drain port and the other hose band over the hard PVC pipe (not supplied). Then connect both ends of the supplied drain hose. (Fig. 6-5)
- (3) On the unit drain side, grasp the hose band with pliers and insert the drain hose all the way to the base.
 - If other commercially available hose bands are used, the drain hose may become pinched or wrinkled and there is danger of water leakage. Therefore be sure to use the supplied hose bands. When sliding the hose bands, be careful to avoid scratching the drain hose.
 - Do not use adhesive when connecting the supplied drain hose to the drain port (either on the main unit or the PVC pipe).
 - Reasons: a) It may cause water to leak from the connection. Since the connection is slippery just after the adhesive has been applied, the pipe easily slips off.
 - b) The pipe cannot be removed when maintenance is needed.
- (4) Wrap the hose with the supplied drain hose insulation and use the 4 twist ties so that the hose is insulated with no gaps.
 - Do not bend the supplied drain hose 90° or more. The hose may slip off.

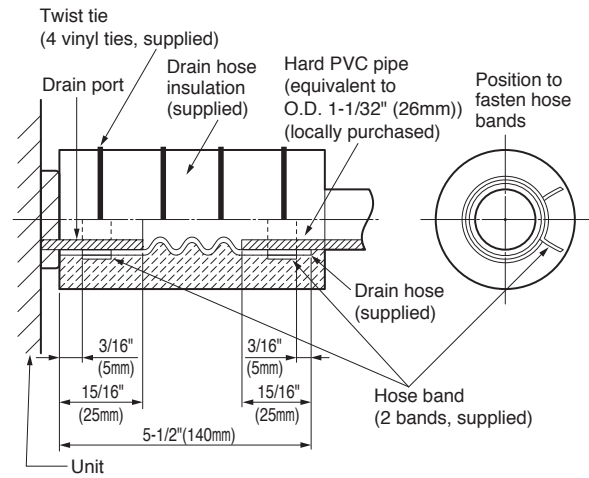

Fig. 6-5



CAUTION

- Attach so that the hose band fastener is on the side of the drain port.
- Attach the hose bands so that each is approximately 3/16" (5 mm) to 15/16" (25 mm) from the end of the supplied drain hose.

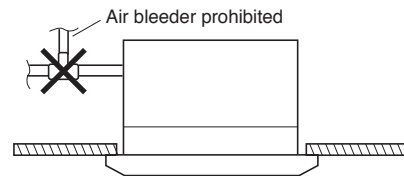

Fig. 6-6



CAUTION

- Do not install an air bleeder as this may cause water to spray from the drain pipe outlet. (Fig. 6-6)

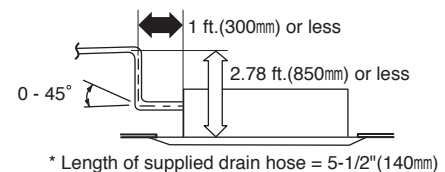

Fig. 6-7

NOTE

Make sure the drain pipe has a downward gradient (1/100 or more) and that there are no water traps.



CAUTION

- In cases where it is necessary to raise the height of the drain piping, the drain piping can be raised to a maximum height of 2.78 ft. (850 mm) above the bottom surface of the ceiling. Under no conditions attempt to raise it higher than 2.78 ft. (850 mm) above the bottom surface of the ceiling. Doing so will result in water leakage. (Fig. 6-7)
- Do not use natural drainage.
- Do not install the pipe with an upward gradient from the connection port. This will cause the drain water to flow backward and leak when the unit is not operating. (Fig. 6-8)
- Do not apply force to the piping on the unit side when connecting the drain pipe. The pipe should not be allowed to hang unsupported from its connection to the unit. Fasten the pipe to a wall, frame, or other support as close to the unit as possible. (Fig. 6-9)
- Provide insulation for any pipes that are run indoors.

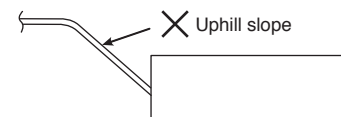

Fig. 6-8

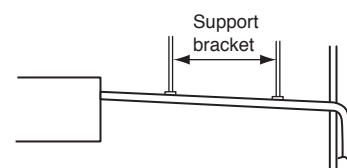

Fig. 6-9

3-5. Checking the Drainage

After wiring and drain piping are completed, use the following procedure to check that the water will drain smoothly. For this, prepare a bucket and wiping cloth to catch and wipe up spilled water.

- Be sure to do the wiring between the units before installing the ceiling panel. (Refer to 3-9. Wiring Instructions for Inter-unit Connections)
- (1) Turn on the power. (Here, "power" refers to the power supply from the outdoor unit.)
 - (2) Slowly pour approx. 16 ounces (500 ml) of water into the drain pan to check drainage. (Fig. 6-10a)
 - (3) Remove the 2 screws from the control box cover, then open the cover. Be careful not to drop the cover at this time.
 - (4) Disconnect the FS 3P connector (red) on the control PCB and operate the drain pump. (Fig. 6-10b) Check the water flow through the transparent drain pipe and see if there is any leakage.
 - (5) When the check of drainage is complete, reconnect the FS 3P connector and remount the control cover.

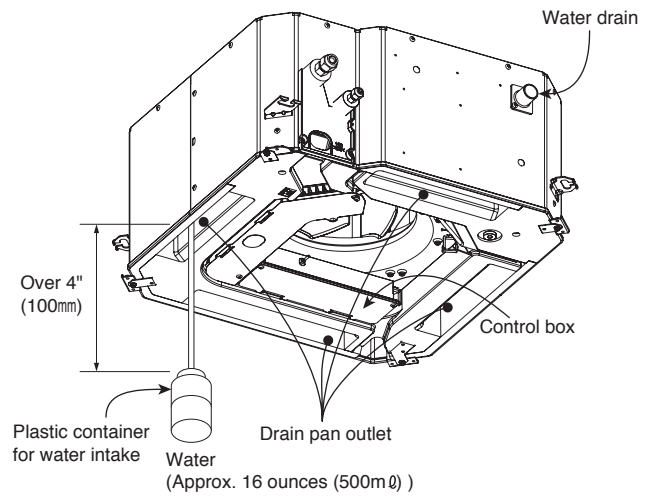

Fig. 6-10a

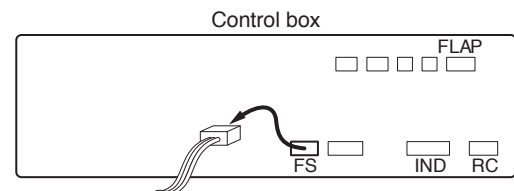

Fig. 6-10b



CAUTION

The drain pump will continue to operate for a minimum of 6 minutes after the FS 3P connector is reconnected.

- Ⓐ must be within the range of 1/2"(13mm) to 23/32"(18mm). (Fig. 6-11)
If not within this range, malfunction or other trouble may occur.

3-6. How to Install the Ceiling Panel

Checking the unit position

- (1) Check that the ceiling hole is 23-5/8" (600 mm) × 23-5/8" (600 mm) (Fig. 6-11)
- (2) Confirm that the position of the indoor unit and the ceiling as shown in the diagram. If the positions of the ceiling surface and unit do not match, air leakage, water leakage, flap operation failure, or other problems may occur. (Fig. 6-11)

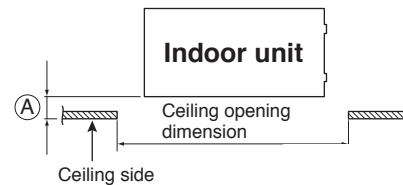

Fig. 6-11

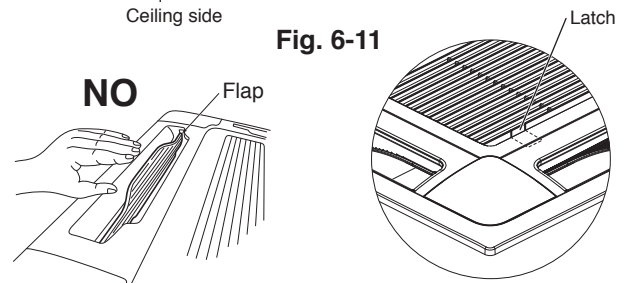

Fig. 6-12

Fig. 6-13



CAUTION

- Never place the panel face-down. Neither hang it vertically nor place it on top of a projecting object. Placing it face-down will damage the surface.
- Do not touch the flap or apply force to it. (This may cause flap malfunction.) (Fig. 6-12)

3-6-1. Before Installing the Ceiling Panel

- (1) Remove the air-intake grille and air filter from the ceiling panel.
 - a) Press on and slide the two latches of the air-intake grille with your thumb in the direction shown by the arrow ① to open the grille. (Figs. 6-13 and 6-14)
 - b) With the air-intake grille opened, remove the grille hinge from the ceiling panel by sliding it in the direction shown by the arrow ②. (Fig. 6-15)

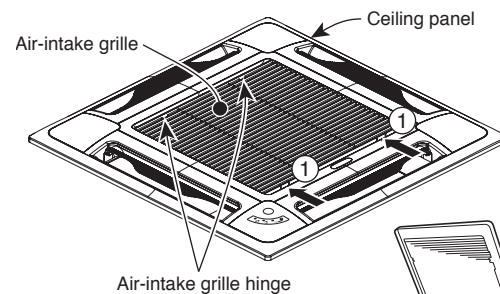

Fig. 6-14

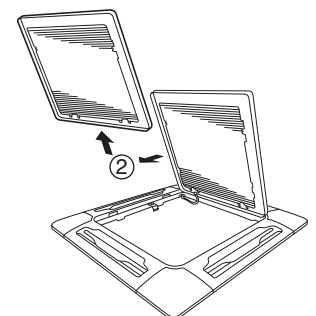

Fig. 6-15

(2) Removing the corner cover and indicator cover

- a) While lightly pressing the center of the corner cover, pull up the tab for the screw hole. Use the same procedure to remove the indicator cover. (Fig. 6-16)

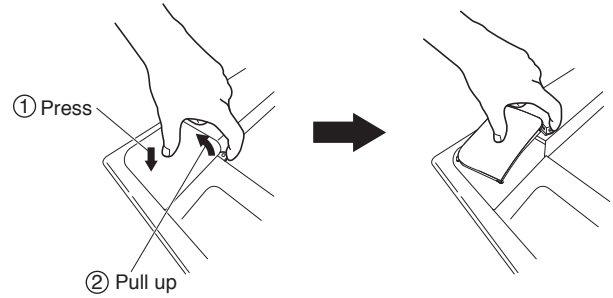
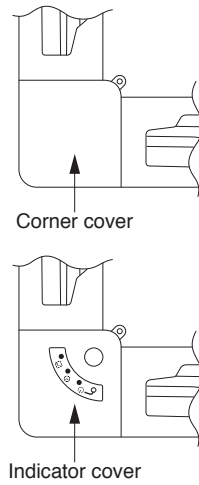

Fig. 6-16

3-6-2. Installing the Ceiling Panel

- (1) Hang the temporary latches on the inside of the ceiling panel to the receptacle on the unit to temporarily attach the ceiling panel in place. (Fig. 6-17)

- The ceiling panel must be installed in the correct direction relative to the unit. Align the REF. PIPE and DRAIN marks on the ceiling panel corner with the correct positions on the unit.

- (2) Align the panel installation holes and the unit screw holes. (Fig. 6-18)

- (3) Tighten the supplied special screws at the 4 panel installation locations so that the panel is attached tightly to the unit.

- Check that the wiring connectors are not caught between the unit and the ceiling panel.

- (4) Check that the panel is attached tightly to the ceiling. (Fig. 6-19)

- At this time, make sure that there are no gaps between the unit and the ceiling panel, or between the ceiling panel and the ceiling surface.

- If there is a gap between the panel and the ceiling, leave the ceiling panel attached and make fine adjustments to the installation height of the unit to eliminate the gap with the ceiling.

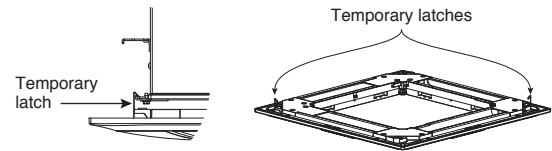

Fig. 6-17

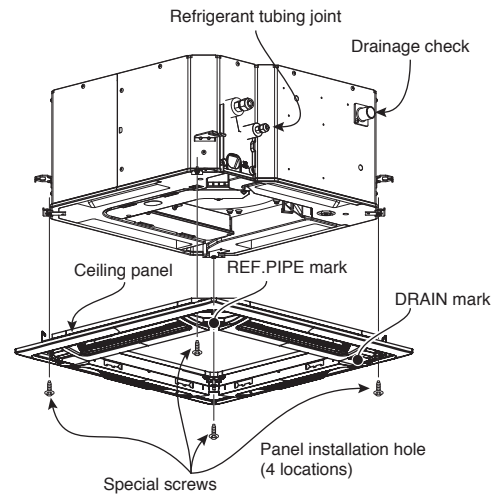

Fig. 6-18

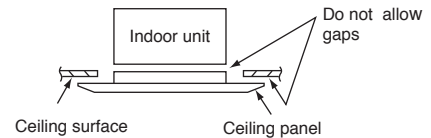
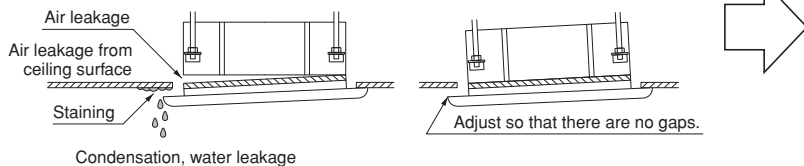

Fig. 6-19



- If the screws are not sufficiently tightened, trouble such as that shown in the figure below may occur. Be sure to tighten the screws securely.

- If a gap remains between the ceiling surface and the ceiling panel even after the screws are tightened, adjust the height of the unit again.



The height of the unit can be adjusted from the ceiling panel corner hole, with the ceiling panel attached, to an extent that does not affect the unit levelness, the drain hose, or other elements.

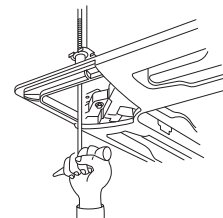
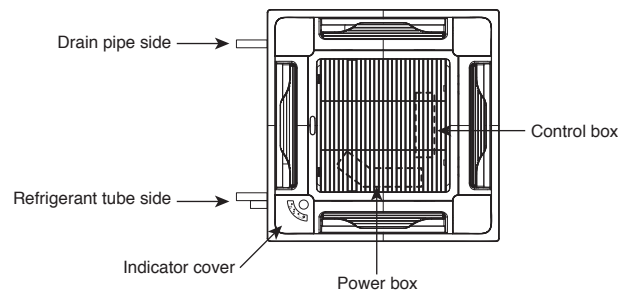

Fig. 6-20

3-6-3. Wiring the Ceiling Panel and the Indicator

- (1) Remove the 2 screws from the control box cover, then open the cover. Be careful that the cover does not fall.
- (2) Connect the 5P FLAP wiring connector from the ceiling panel to the connector on the control PCB in the control box. (Fig. 6-21)
- (3) Connect the 7P IND and 4P RC wiring connector from the indicator to the connectors on the control PCB in the control box. (Fig. 6-21)
- (4) Be sure to use the clamps to fasten the connector wires in place. (Fig. 6-21)



As to how to attach the indicator cover, refer to Fig. 6-23.

Fig. 6-22

- (5) Tighten the 2 cover screws to close the cover.
 - Check that the wiring connectors are not caught between the electrical component box and the cover.
 - If the indicator connector is not securely connected, the remote controller signal will not be received.
 - If the connectors are not connected, the auto flap will not operate. Be sure to connect them securely.

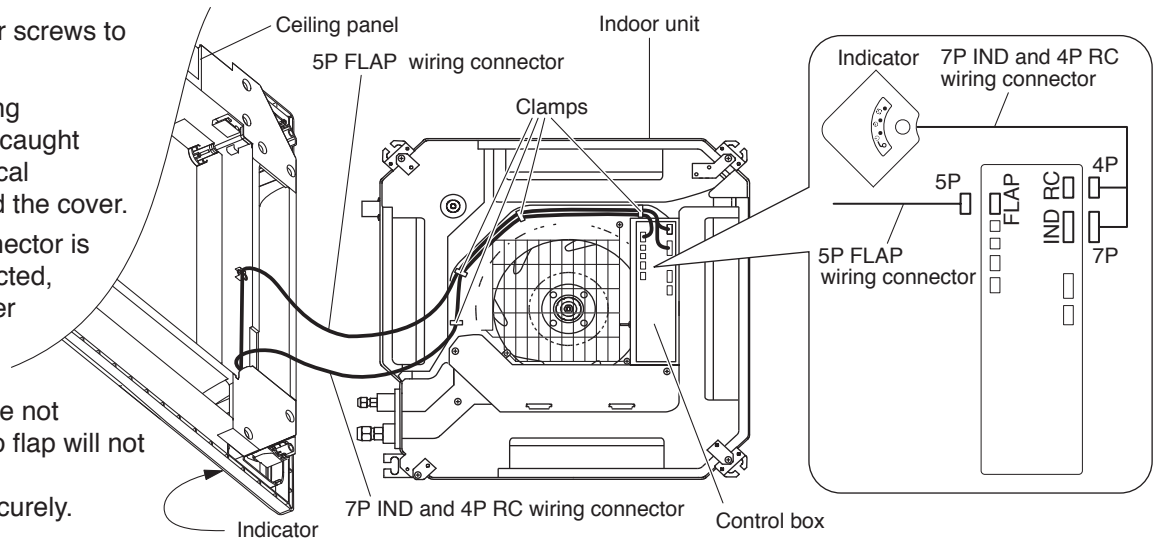

* Pass the wiring connectors through the clamps to fasten them in place, as shown in the figure.

Fig. 6-21

3-6-4. How to Attach the Corner Cover and Air-Intake Grille

A. Attaching the corner cover

- (1) Check that the safety strap from the corner cover is fastened to the ceiling panel pin, as shown in the figure. (Fig. 6-23)
- (2) Use the supplied screws to attach the corner cover to the ceiling panel.

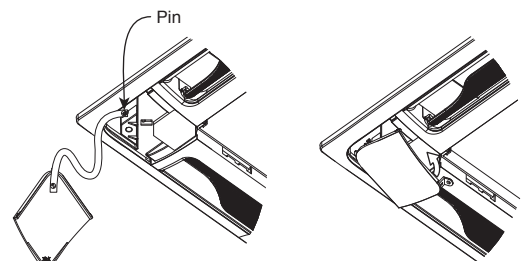

Place the corner cover so that the 3 tabs fit into the holes in the ceiling panel. Then fasten it in place with the supplied screws.

Fig. 6-23

B. Attaching the air-intake grille

- To install the air-intake grille, follow the steps for 3-6-1. **Before Installing the Ceiling Panel** in the reverse order. By rotating the air-intake grille, it is possible to attach the grille onto the ceiling panel from any of 4 directions. (Fig. 6-25)

- **When attaching the air-intake grille, be careful that the flap and the indicator wiring do not become caught.**
- **Be sure to attach the safety cord that prevents the air-intake grille from dropping off to the ceiling panel unit as shown in Fig. 6-24.**

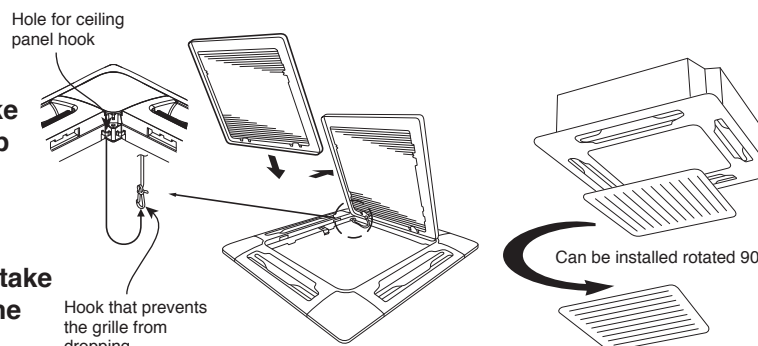

Fig. 6-24

Fig. 6-25

* The grille can be installed with these hinges facing in any of 4 directions.

3-6-5. Checking After Installation

- Check that there are no gaps between the unit and the ceiling panel, or between the ceiling panel and the ceiling surface. Gaps may cause water leakage and condensation.
- Check that the wiring is securely connected.
If it is not securely connected, the auto flap will not operate. In addition, water leakage and condensation may occur.

3-6-6. When Removing the Ceiling Panel for Servicing

When removing the ceiling panel for servicing, remove the air-intake grille and air filter, disconnect the flap and the indicator wiring connectors inside the control box, and then remove the 4 mounting screws.

3-6-7. Adjusting the Auto Flap

The air-direction flap on the ceiling panel outlet can be adjusted as follows.

- Adjust the flap to the desired angle using the remote controller. The flap also has an automatic air-sweeping mechanism.

NOTE

- Never attempt to move the flap by hand.
- Proper air flow depends on the location of the air conditioner, the layout of the room and furniture, etc. If cooling or heating seems inadequate, try changing the direction of the air flow.

3-7. Wiring Instructions

General precautions on wiring

- (1) Before wiring, confirm the rated voltage of the unit as shown on its nameplate, then carry out the wiring closely following the wiring diagram.
- (2) Provide a power outlet to be used exclusively for each unit, with a power supply disconnect and circuit breaker for overcurrent protection provided in the exclusive line.
- (3) To prevent possible hazards due to insulation failure, the unit must be grounded.
- (4) Each wiring connection must be done tightly and in accordance with the wiring system diagram. Wrong wiring may cause the unit to misoperate or become damaged.
- (5) Do not allow wiring to touch the refrigerant tubing, compressor, or any moving parts of the fan.
- (6) Unauthorized changes in the internal wiring can be very dangerous. The manufacturer will accept no responsibility for any damage or misoperation that occurs as a result of such unauthorized changes.

3-8. Recommended Wire Length and Diameter

Regulations on wiring diameter differ from locality to locality. For field wiring requirements, please refer to your local electrical codes. Carefully observe these regulations when carrying out the installation.

Table 4 lists recommended wire lengths and diameters for power supply systems.

NOTE

Refer to the wiring system diagram (Fig. 7a or Fig. 7b) for the meaning of (A), (B) and (C) in Table 4.

Refer to your local codes or in the absence of local codes see the National Electric Code: ANSI/NFPA70.

Table 4

Cross-Sectional Area (AWG) Model	(A)+(B)	(A) Power Supply Wiring Length (ft) (B) Power Line Length (ft)	(C) Control Line Length (ft)	Fuse or Circuit Breaker Capacity
	(#14)	(#12)	(#14)	
CU-KE12NK1	131 (Max.)	230 (Max.)	65 (Max.)	20A
CU-KE18NKU	131 (Max.)	230 (Max.)	100 (Max.)	15A

... AWG (American Wire Gauge)



WARNING

- Be sure to comply with local codes on running the wire from the indoor unit to the outdoor unit (size of wire and wiring method, etc.).
- Each wire must be firmly connected.
- No wire should be allowed to touch refrigerant tubing, the compressor, or any moving part.

**WIRING SYSTEM DIAGRAM
(CU-KE12NK1)**

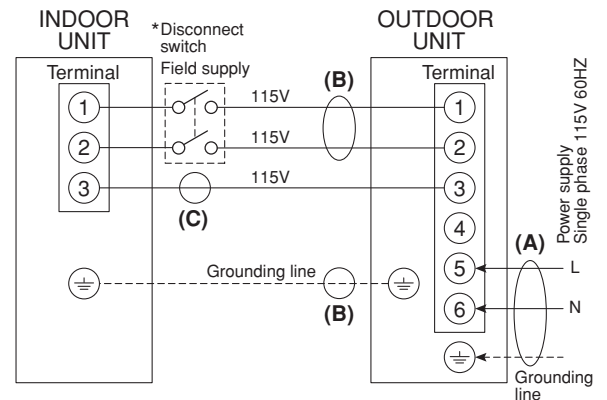

Fig. 7a

(CU-KE18NKU)

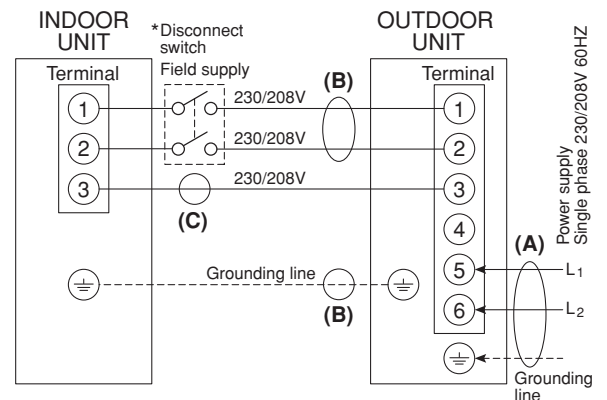

Fig. 7b



WARNING

- To avoid the risk of electric shock, each air conditioner unit must be grounded.
- For the installation of a grounding device, please observe local electrical codes.
- Grounding is necessary, especially for units using inverter circuits, in order to release charged electricity and electrical noise caused by high tension. Otherwise, electrical shock may occur.
- Place a dedicated ground more than 7' (2 m) away from other grounds and do not have it shared with other electric appliances.



CAUTION

- Be sure to connect the power supply line to the outdoor unit as shown in the wiring diagram. The indoor unit draws its power from the outdoor unit.
- Do not run wiring for antenna, signal, or power lines of television, radio, stereo, telephone, security system, or intercom any closer than 3'3" (1 m) from the power cable and wires between the indoor and outdoor units. Electrical noise may affect the operation.

*** NOTE**

A disconnect switch may be required by national or local codes.



CAUTION

Always comply with national and local code requirements.

3-9. Wiring Instructions for Inter-unit Connections

- (1) Remove the 1 screw from the terminal cover, then open the cover. Be careful that the cover does not fall.
- (2) Remove the 3 screws from the power box cover, then open the cover. Be careful that the cover does not fall.
- (3) Use the screw to securely fasten the ground wire from the outdoor unit in place.
- (4) Remove the transparent plastic cover from the 3P terminal plate.
- (5) While viewing the wiring diagram, connect the inter-unit and power supply line to terminals 1, 2 and 3 on the 3P terminal plate.
- (6) Remount the transparent plastic cover onto the 3P terminal plate.
- (7) Be sure to use the clamping strap to fasten the wires in place.
- (8) Tighten the screws to remount the terminal and the power box cover.

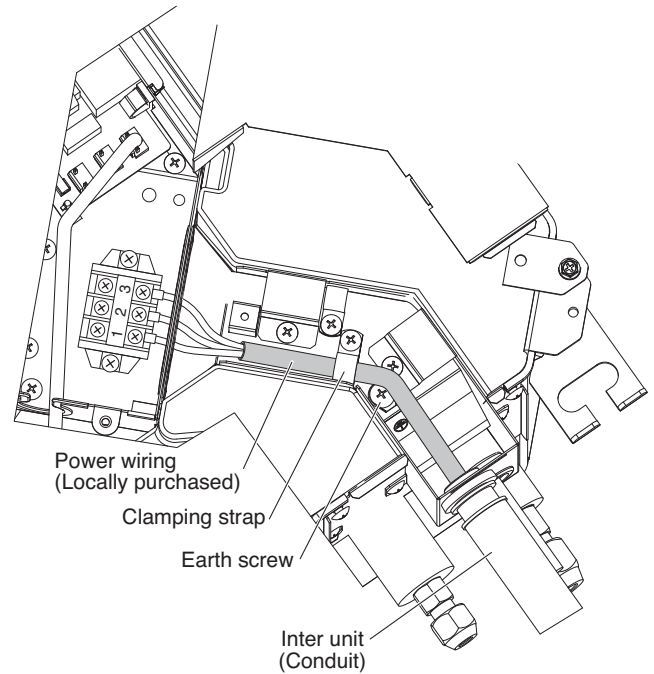

Fig. 8



WARNING

Loose wiring may cause the terminal to overheat or result in unit malfunction. A fire hazard may also exist. Therefore, be sure all wiring is tightly connected.

When connecting each power wire to the corresponding terminal, follow the instructions "How to connect wiring to the terminal" and fasten the wire securely tight with the fixing screw of the terminal plate.

How to connect wiring to the terminal

a) For Indoor Unit

- (1) Cut the wire end with a cutting pliers, then strip the insulation to expose the wire about 9/32" (7 mm). See the label (Fig. 9) near the terminal plate.
- (2) Using a screwdriver, loosen the terminal screw on the terminal plate.
- (3) Insert the wire and tighten the terminal screw completely using a screwdriver.

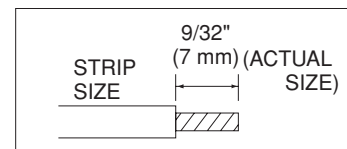

Fig. 9

b) For Outdoor Unit

■ For solid core wiring (or F-cable)

- (1) Cut the wire end with a cutting pliers, then strip the insulation to expose the solid wire about 15/16" (25 mm). (Fig. 10)
- (2) Using a screwdriver, remove the terminal screw(s) on the terminal plate.
- (3) Using the pliers, bend the solid wire to form a loop suitable for the terminal screw.
- (4) Shape the loop wire properly, place it on the terminal plate and fix it securely with the removed terminal screw using a screwdriver.

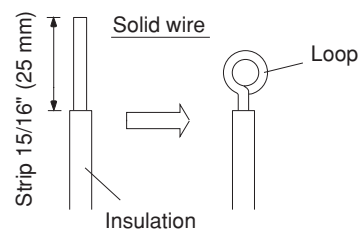

Fig. 10

■ For stranded wiring

- (1) Cut the wire end with a cutting pliers, then strip the insulation to expose the stranded wiring about 3/8" (10 mm) and tightly twist the wire ends. (Figs. 11 and 12)
- (2) Using a screwdriver, remove the terminal screw(s) on the terminal plate.
- (3) Using a ring connector fastener or pliers, securely clamp each stripped wire end with a ring connector. (Fig. 11)
- (4) Place the ring connector wire, and replace and tighten the removed terminal screw using a screwdriver. (Fig. 13)

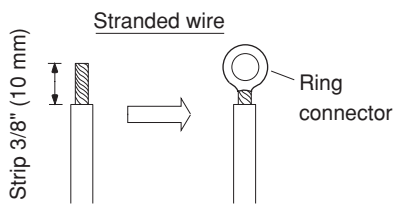

Fig. 11

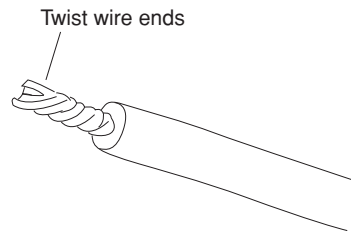

Fig. 12

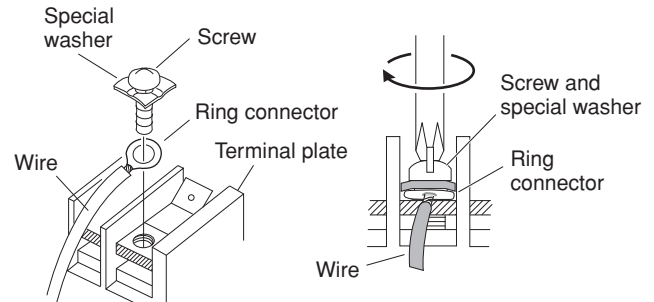

Fig. 13

4. How to Install the Outdoor Unit

First refer to Section 2. Installation Site Selection.

4-1. Wiring Instructions for the Outdoor Unit

Regulations on wire size differ from locality to locality. For field wiring requirements, please refer to your local electrical codes. Make sure that the installation fully complies with all local and national regulations.

- (1) Remove access panel "C". (Fig. 14)
- (2) Connect the inter-unit and power supply line according to the drawing on the panel side.
- (3) Be sure to size each wire allowing approx. 4" (10 cm) longer than the required length for wiring. Store excess wiring inside the cabinet.
- (4) When connections are completed, check that all connections are correct as shown in the wiring system diagram on panel side.
- (5) Be sure to ground the unit according to your local codes.

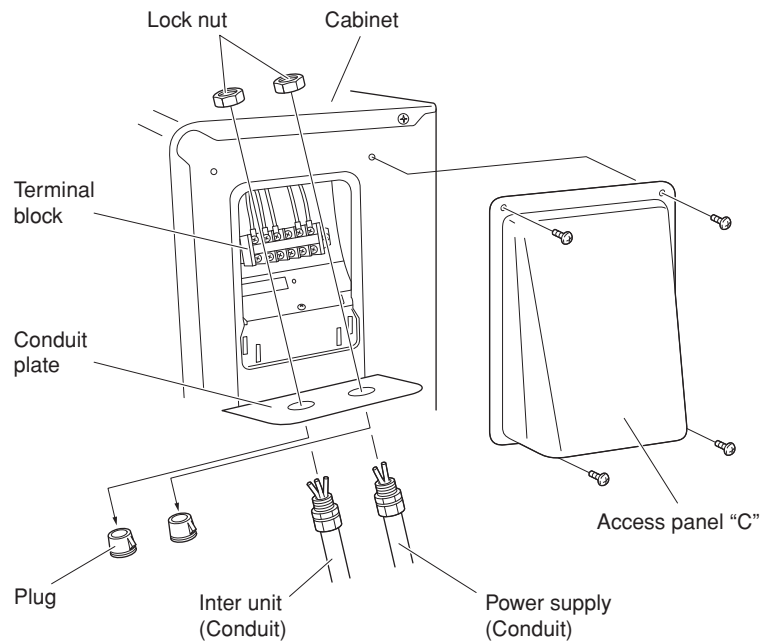

Fig. 14

5. Refrigerant Tubing

5-1. Use of the Flaring Method

Many of the conventional split system air conditioners employ the flaring method to connect refrigerant tubes which run between indoor and outdoor units. In this method, the copper tubes are flared at each end and connected with flare nuts.

5-2. Flaring Procedure with a Flare Tool

- (1) Cut the copper tube to the required length with a tube cutter. It is recommended to cut approx. 12" to 20" (30 to 50 cm) longer than the tubing length you estimate.
- (2) Remove burrs at the end of the copper tube with a tube reamer or file. This process is important and should be done carefully to make a good flare. (Fig. 15)

NOTE

When reaming, hold the tube end downward and be sure that no copper scraps fall into the tube. (Fig. 16)

- (3) Remove the flare nut from the unit and be sure to mount it on the copper tube.
- (4) Make a flare at the end of copper tube with a flare tool.* (Figs. 17 and 18)
(*Use "RIDGID" or equivalent.)

NOTE

A good flare should have the following characteristics:

- inside surface is glossy and smooth.
- edge is smooth.
- tapered sides are of uniform length.

5-3. Caution before Connecting Tubes Tightly

- Be sure to apply a sealing cap or water-proof tape to prevent dust or water from getting into the tubes before they are used.
- Be sure to apply refrigerant lubricant to the matching surfaces of the flare and union before connecting them together. This is effective for reducing gas leaks. (Fig. 19)
- For proper connection, align the union tube and flare tube straight with each other, then screw in the flare nut lightly at first to obtain a smooth match. (Fig. 20)

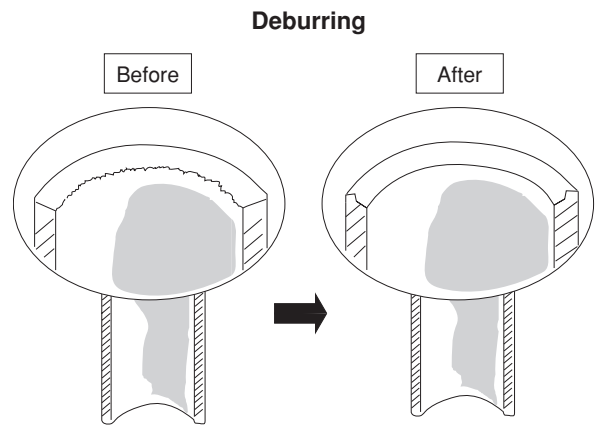

Fig. 15

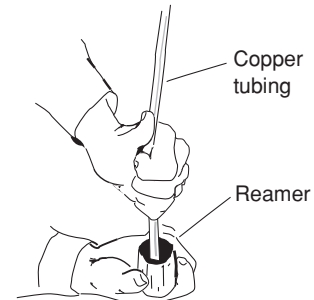
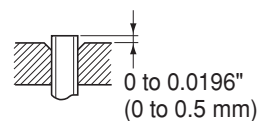
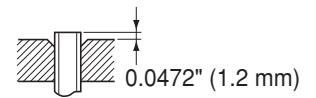

Fig. 16

If the special R410A flare tool is used:



If the previous flare tool (clutch-type) is used:



Adjust so that the amount of tube protrusion is as shown in the figure.

Fig. 17

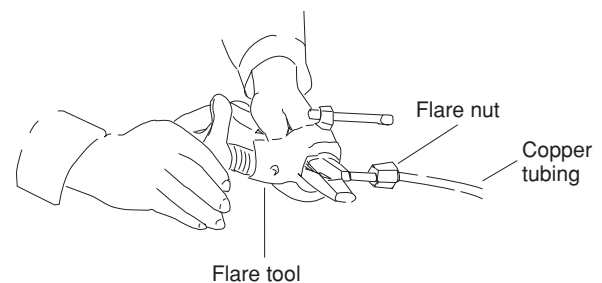

Fig. 18

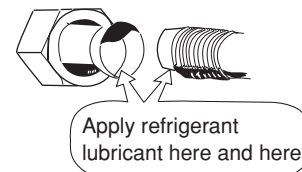

Fig. 19

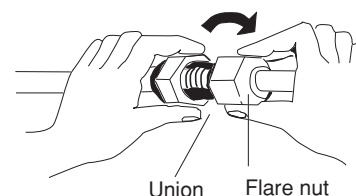

Fig. 20

5-4. Connecting Tubing between Indoor and Outdoor Units

- Tightly connect the indoor side refrigerant tubing extended from the wall with the outdoor side tubing. (Fig. 21)
- To fasten the flare nuts, apply specified torque as:

Table 5

Tube Dia.	Nut	Tightening Torque
1/4" (6.35 mm)	21/32" (17 mm)	Approx. 120 – 160 lbs·in (140 – 180 kgf·cm)
3/8" (9.52 mm)	7/8" (22 mm)	Approx. 300 – 360 lbs·in (340 – 420 kgf·cm)
1/2" (12.70 mm)	1-1/32" (26 mm)	Approx. 430 – 480 lbs·in (490 – 550 kgf·cm)
5/8" (15.88 mm)	1-5/32" (29 mm)	Approx. 590 – 710 lbs·in (680 – 820 kgf·cm)

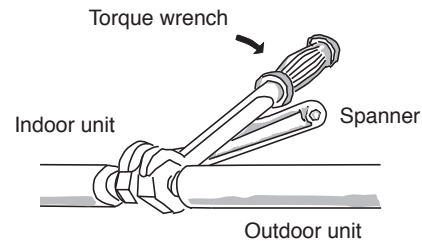

Fig. 21

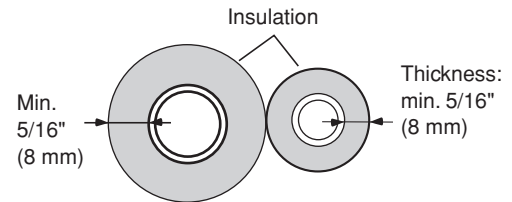

Fig. 22

5-5. Insulation of Refrigerant Tubing

IMPORTANT

To prevent heat loss and wet floors due to dripping of condensation, **both tubes must be well insulated with a proper insulation material.**

The thickness of the insulation should be a minimum 5/16" (8 mm). (Fig. 22)

Taping the flare nuts

Wind the insulation tape around the flare nuts at the tube connections. Secondly cover up the tubing connections with the flare insulation (1/8" (T3, supplied)). Then wind the other flare insulation (3/16" (T5, supplied)). Finally, fasten the insulation at both ends with the supplied vinyl ties. (Fig. 23)

Insulation material

The material used for insulation must have good insulation characteristics, be easy to use, be age resistant, and must not easily absorb moisture.

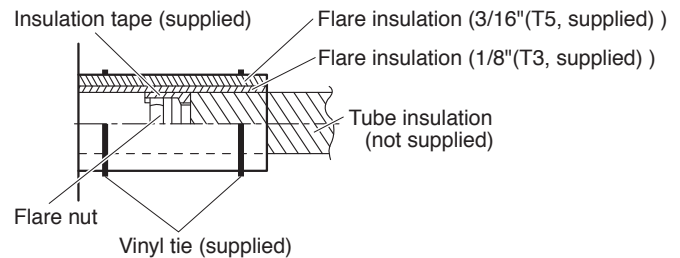

Fig. 23

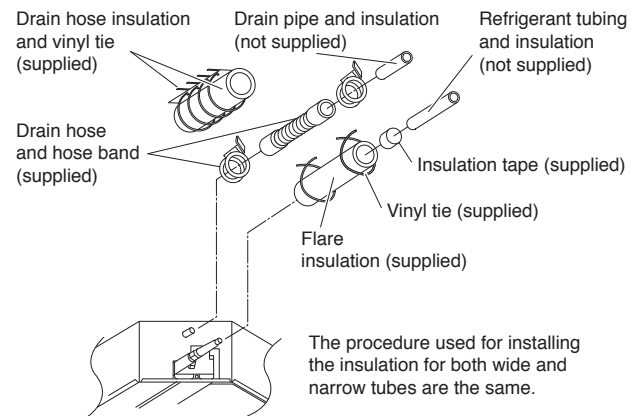

Fig. 24



CAUTION

After a tube has been insulated, never try to bend it into a narrow curve because it can cause the tube to break or crack.

Never grasp the drain or refrigerant connecting outlets when moving the unit.

5-6. Taping the Tubes

- (1) At this time, the 2 refrigerant tubes (and electrical wire if local codes permit) should be taped together with armoring tape. The drain hose may also be included and taped together as 1 bundle with the tubing.
- (2) Wrap the armoring tape from the bottom of the outdoor unit to the top of the tubing where it enters the wall. As you wrap the tubing, overlap half of each previous tape turn. (Fig. 25)
- (3) Clamp the tubing bundle to wall, using 1 clamp approx. every 47" (120 cm).

NOTE

Do not wind the armoring tape too tightly, since this will decrease the heat insulation effect. Also, be sure the condensation drain hose splits away from the bundle and drips clear of the unit and the tubing.

5-7. Finishing the Installation

After finishing insulating and taping over the tubing, use sealing putty to seal off the hole in the wall to prevent rain and draft from entering. (Fig. 26)

6. Air Purging

Air and moisture remaining in the refrigerant system have undesirable effects as indicated below. Therefore, they must be purged completely.

- pressure in the system rises
- operating current rises
- cooling (or heating) efficiency drops
- moisture in the air may freeze and block capillary tubing
- water may lead to corrosion of parts in the refrigerant system

■ Air Purging with a Vacuum Pump (for Test Run)

- (1) Check that each tube (both narrow and wide tubes) between the indoor and outdoor units have been properly connected and all wiring for the test run has been completed. Note that both narrow and wide tube service valves on the outdoor unit are kept closed at this stage.
- (2) Using an adjustable wrench or box wrench, remove the valve caps from the service valve on both narrow and wide tubes.
- (3) Connect a vacuum pump and a manifold valve (with pressure gauges) to the service port on the wide tube service valve. (Fig. 27)



CAUTION

The service port on the wide tube service valve uses a Schrader core valve to access the refrigerant system. The valve core is similar to those used in automobile tires. Therefore, be sure to use a vacuum hose connector which has a push-pin inside.



CAUTION

Be sure to use a manifold valve for air purging. If it is not available, use a stop valve (field supply) for this purpose. The "Hi" knob of the manifold valve must always be kept closed.

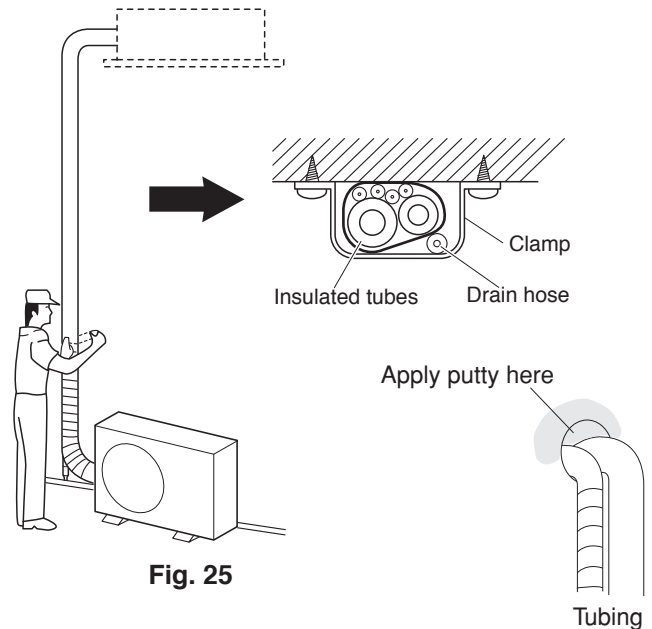

Fig. 25

Fig. 26

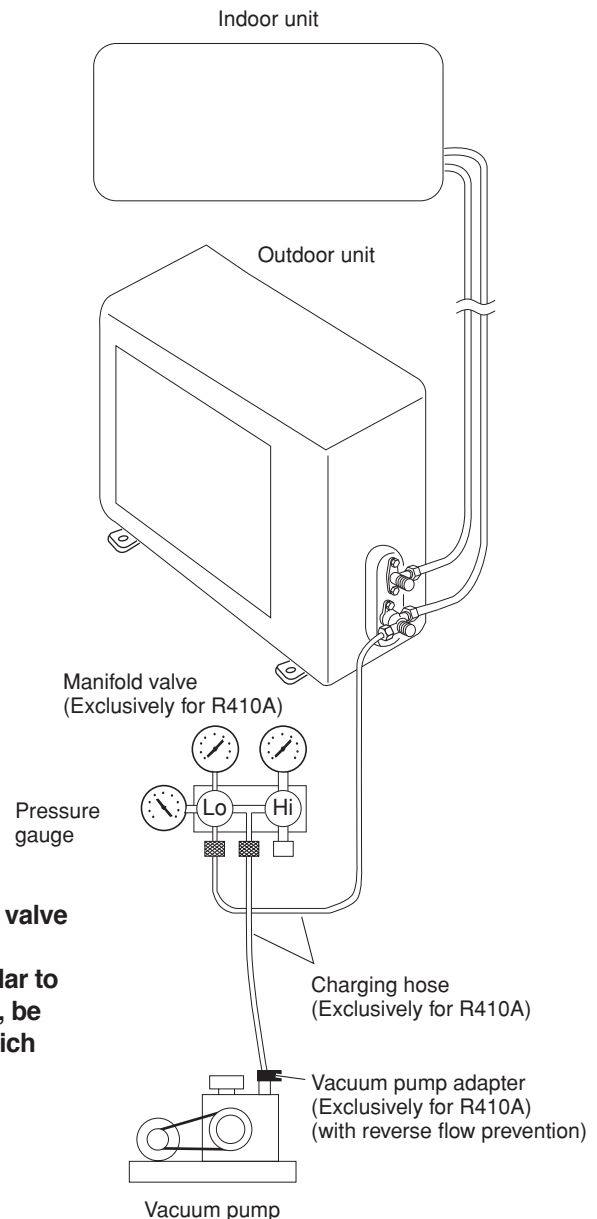

Fig. 27

- (4) With the “Lo” knob of the manifold valve open, run the vacuum pump. The operation time for the vacuum pump varies with tubing length and the capacity of the pump. The following table shows the amount of time for evacuation:

Table 6

Required time for evacuation when 26.4 gal/h (100 liter/h) vacuum pump is used	
If tubing length is less than 33 ft. (10 m)	If tubing length is more than 33 ft. (10 m)
10 min. or more	15 min. or more

- (5) With the vacuum pump still running, close the “Lo” knob of the manifold valve. Then stop the vacuum pump.
- (6) With the hex wrench, turn the valve stem on the narrow tube service valve counter-clockwise by 90 degrees (1/4 turn) for 10 seconds, and then turn the stem clockwise to close it again. (Fig. 28)



CAUTION

Be sure to completely insert the hex wrench before attempting to turn the valve.

- (7) Leak test all joints at the tubing (both indoor and outdoors) with soapy water. Bubbles indicate a leak. Tighten the joint more when leaks, then check if there is no leak. Be sure to wipe off the soap with a clean cloth.
- (8) With the hex wrench, turn the wide tube service valve stem counter-clockwise to fully open the valve.
- (9) Turn the narrow tube service valve stem counter-clockwise to fully open the valve.
- (10) Loosen the vacuum hose connected to the wide tube service port slightly to release the pressure. Then, remove the hose.



CAUTION

This may cause the refrigerant gas to leak. In order to avoid this, take off the hose quickly.

- (11) Fasten the valve cap on the wide tube service port securely with an adjustable wrench or box wrench. Next, mount the valve cap on the service valve and tighten it to 170 lbs-in (200 kgf-cm) with a torque wrench. This process is very important to prevent gas from leaking from the system.
- (12) Test run the air conditioner. (See next page.)
- (13) While the air conditioner is running, apply liquid soap to check for any gas leaks around the service valves or caps.
- (14) If there is no leakage, stop the air conditioner.
- (15) Wipe off the soap on the tubing.

This completes air purging with a vacuum pump and the air conditioner is ready for actual operation.

NOTE

To prevent other refrigerants from being mistakenly charged to units which use R410A, the size of the charge port on the service valve is different from the one for other refrigerant types. For servicing such as recharging, the specified charging hose, manifold and vacuum pump adapter (with reverse flow prevention) for R410A must be used.

NOTE

The required time in Table 6 is calculated based on the assumption that the ideal (or target) vacuum condition is around 0.193 psi (10 mmHg abs.).

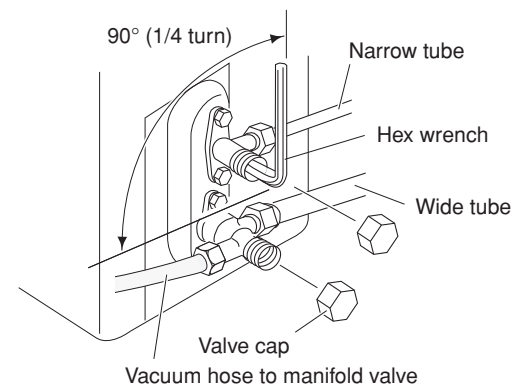

Fig. 28

How to Test Run the Air Conditioner

After turning on the power of the air conditioner, use the remote controller and follow the steps below to conduct the test run.

- (1) Set the remote controller in Test Run mode. (Fig. 29)
 - a) Press and hold the HIGH POWER button and the 1HR. TIMER button.
 - b) Then press and hold the ACL (Reset) button with a pointed object such as the tip of a pen. After 5 seconds, release the ACL button first.
 - c) Then release the HIGH POWER and 1HR. TIMER buttons.
 - d) ✻ appears and “oP-1” blinking in the remote controller clock display area. (Fig. 30)
- (2) Start Cooling mode test run by pressing the ON/OFF operation button of the remote controller. (Fig. 29)
 - This starts the fan producing uncooled forced air with the 3 indicator lamps (OPERATION lamp, TIMER lamp, and HIGH POWER lamp) on the main unit blinking. (Fig. 31)
 - After 3 minutes, the system shifts into cooling operation, and cool air will start to be felt. Cooling mode test run is unaffected by the room temperature.
- (3) Press the ON/OFF operation button of the remote controller again to stop the test run. (Fig. 29)
- (4) Finally press the ACL (Reset) button of the remote controller to release it from Test Run mode to return to normal mode. (Fig. 29)
 - “✻” and “oP-1” will disappear from the remote controller clock display area.

NOTE

Troubleshooting:

In the event that the green OPERATION lamp is blinking upon powering up the system, an error condition exists. In this case, refer to the self-diagnostics procedure which can be seen by opening the air-intake grille.

IMPORTANT

After the test run is completed, be sure to press the ACL (Reset) button to return to normal mode. The air conditioner will not operate correctly if this is not done.

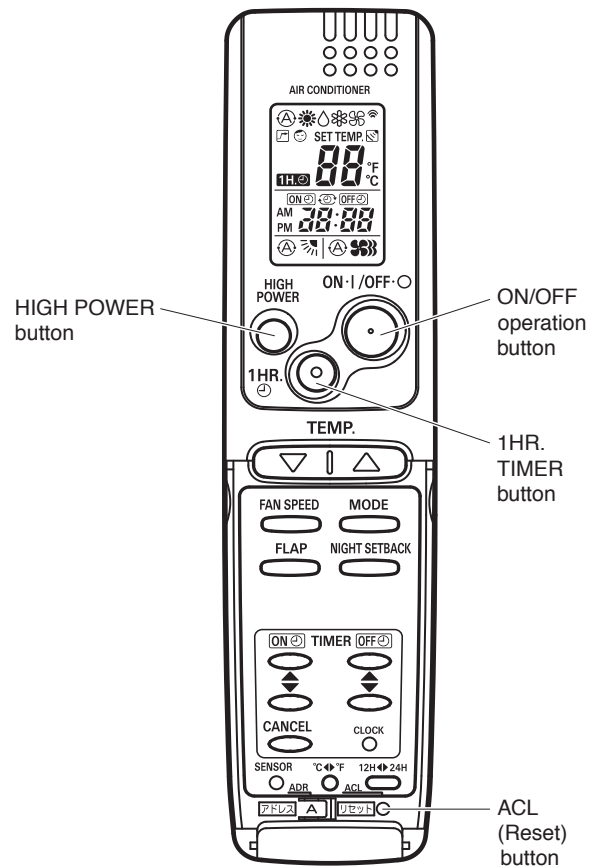

Fig. 29

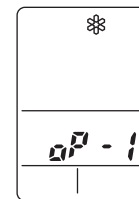

Fig. 30

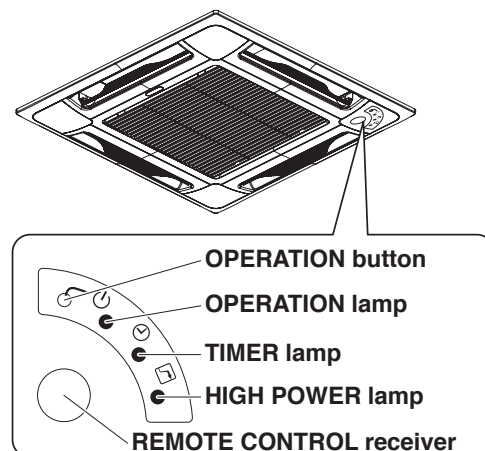
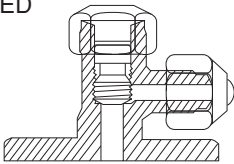
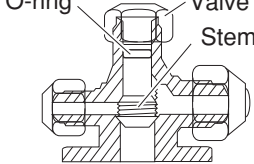
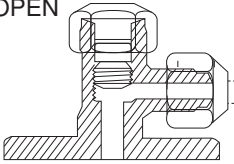
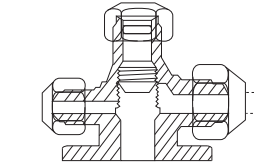
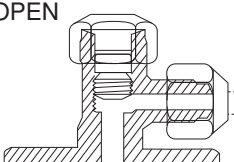
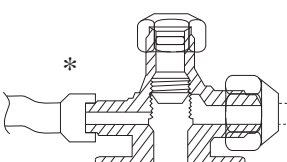
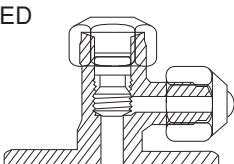
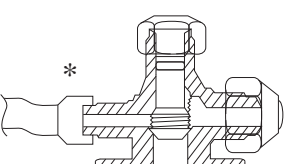

Fig. 31

■ Basic Functions of the Service Valves

The basic functions of the service valves are given in Table 7 below.

Table 7

Action	Narrow Tube Service Valve (2-Way)	Wide Tube Service Valve (3-Way)
Shipping	CLOSED 	O-ring, Valve cap, Stem 
Operating and test running the air conditioner	Fully OPEN 	
Measuring pressure and gas charging	Fully OPEN 	* 
Air purging with a vacuum pump	CLOSED 	* 

* The service port on the wide tube service valve uses a Schrader core valve to access the refrigerant system. Therefore, be sure to use a hose connector which has a push-pin inside. (Fig. 32)



CAUTION

When opening or closing the service valve stem, use the hex wrench. Be sure to fully seat the wrench before turning the valve.

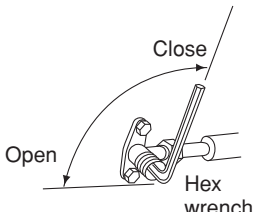
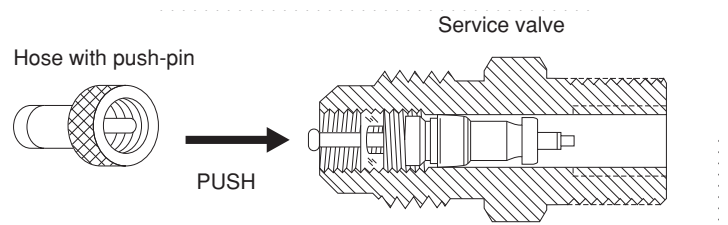

Fig. 33



NOTE

External diameter of service port R410A: 5/16"

Fig. 32

■ Pump Down

Pump down means collecting all refrigerant gas in the system back into the outdoor unit without losing any of the gas. Pump down is used when the unit is to be moved or before servicing the refrigerant circuit.

Pump Down Procedure

Be sure to carry out pump down with the unit in Cooling mode.

- (1) Connect the Lo side charging hose of the manifold valve to the service port on the wide tube service valve.

- (2) Using a hex wrench, turn the narrow tube service valve clockwise all the way to close the service valve. (Be sure to confirm that the wide tube service valve is fully open.)
- (3) Press the operation button and start cooling operation.
- (4) When the low pressure gauge reading falls to 14.2 to 7.1 psi (1 to 0.5 kg/cm²), fully close the wide tube valve stem. Then quickly stop the unit.
- (5) Disconnect all gauges and hoses, and replace the valve caps as they were before.

■ Service Valve Connections

- a) Temporary connection:
Screw in 3 – 5 turns by hand. (Fig. 34)
- b) To fasten the flare nuts, apply specified torque as Table 8 and Fig. 35.

Table 8

Tube Dia.	Nut	Tightening Torque
1/4" (6.35 mm)	21/32" (17 mm)	Approx. 120 – 160 lbs·in (140 – 180 kgf·cm)
3/8" (9.52 mm)	7/8" (22 mm)	Approx. 300 – 360 lbs·in (340 – 420 kgf·cm)
1/2" (12.70 mm)	1-1/32" (26 mm)	Approx. 430 – 480 lbs·in (490 – 550 kgf·cm)
5/8" (15.88 mm)	1-5/32" (29 mm)	Approx. 590 – 710 lbs·in (680 – 820 kgf·cm)

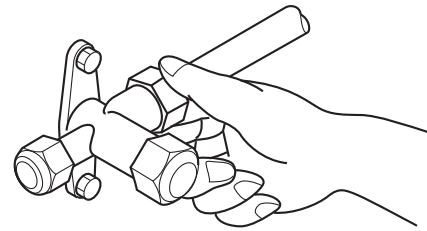

Fig. 34

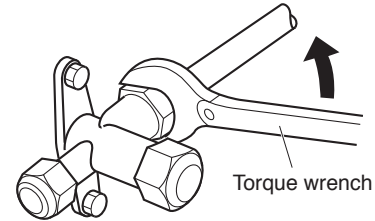

Fig. 35

7. Remote Controller Installation Position

The remote controller can be operated from either a non-fixed position or a wall-mounted position.

To ensure that the air conditioner operates correctly, do not install the remote controller in the following places:

- In direct sunlight
- Behind a curtain or other place where it is covered
- More than 26' (8 m) away from the air conditioner
- In the path of the air conditioner's airstream
- Where it may become extremely hot or cold
- Where it may be subject to electrical or magnetic interference
- Where there is an obstacle between the remote controller and the air conditioner (since a check signal is sent from the remote controller every 5 minutes)



CAUTION

Be sure to tighten the flare nut using the prescribed torque. If the nut is over-tightened, refrigerant leakage may occur.

7-1. Mounting on a Wall

Before mounting the remote controller, press the ON/OFF operation button at the mounting location to make sure that the air conditioner operates from that location. The indoor unit should make a beeping sound to indicate that it has received the signal.

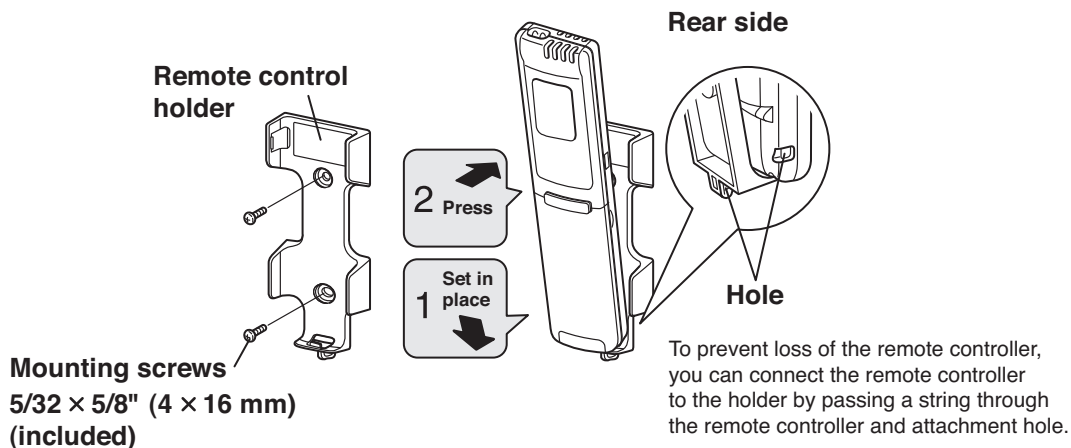

To take out the remote controller, pull it forward.

Fig. 36

8. Address Switch

8-1. Address Setting of the Remote Controller

The address can be set in order to prevent interference between remote controllers when 2 indoor units are installed near each other. The address is normally set to "A." To set a different address, it is necessary to change the address on the second remote controller.

NOTE

Once changed, you cannot restore the original address setting of the air conditioner.

- (1) Switch on the power source.
- (2) Break the address-setting tab marked "A" on the second remote controller to change the address (Fig. 37). When the tab is removed, the address is automatically set to B (Fig. 38).
- (3) Press and hold the remote controller HIGH POWER button and 1HR. TIMER button. Then, press and hold the ACL (Reset) button with a pointed object such as the tip of a pen. After 5 seconds, release the ACL button first, then release the HIGH POWER and 1HR. TIMER buttons. "oP-1" (Test Run) appears, blinking in the remote controller clock display area.
- (4) Each time the 1HR. TIMER button is pressed, the display changes as shown below. Press this button 2 times to change the display to "oP-7" (Address setting). (Fig. 39)

oP-1	Test run mode
oP-3	Self-diagnostic mode
oP-7	Address setting mode

- (5) "oP-7" has now been selected for address setting.
- (6) Press the ON/OFF operation button on the remote controller. (Fig. 39) Check that the "beep" signal-received sound is heard from the second indoor unit (approximately 5 times). The sound you hear is the signal that the remote controller address has been changed.
- (7) Finally press the remote controller ACL (Reset) button to cancel the blinking "oP-7" display. (Fig. 39)

Changing of the second remote controller address is now completed.

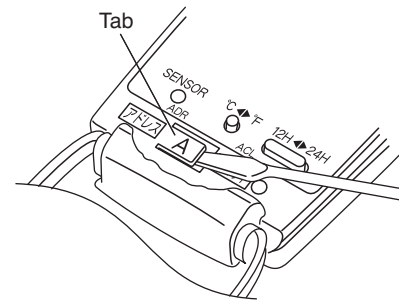

Fig. 37

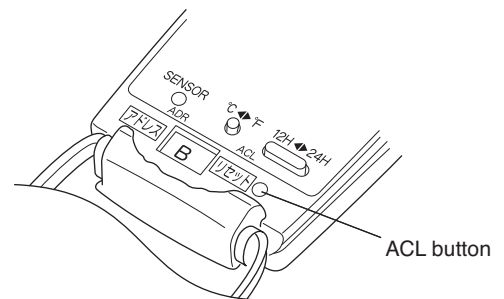

Fig. 38

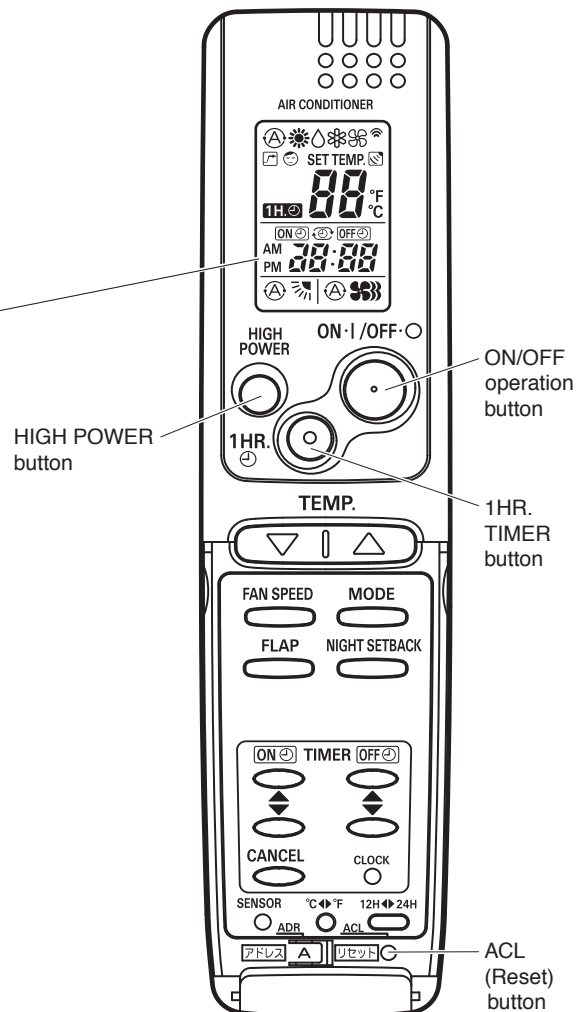

Fig. 39

APPENDIX C Operating Instructions

CZ-RD515U

(852-6-4181-230-00-1)

Operating Instructions Wired Remote Controller

Model No. **CZ-RD515U**

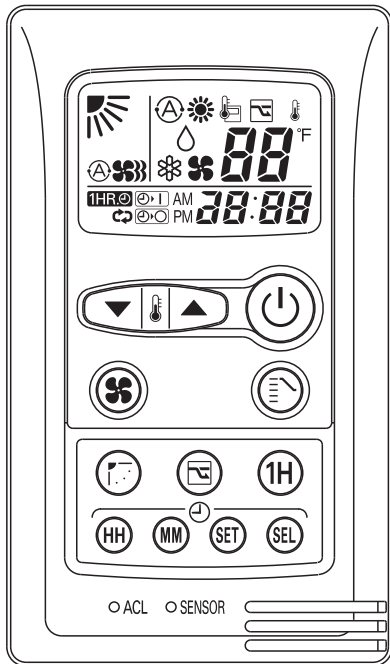

This wired remote controller is designed for both the “COOL/DRY/HEAT Model” and “COOL/DRY Model” indoor unit.

Once the wired remote controller is connected, the wireless remote controller cannot be used.



Before operating the unit, read these operating instructions thoroughly and keep them for future reference.

FEATURES

- Microprocessor Controlled Operation**
 The interior compartment of the remote controller contains several features to facilitate automatic operation, easy logically displayed for easy use.
- 24-Hour ON or OFF Timer**
 This timer can be set to automatically turn the unit on or off at any time within a 24 hour period.
- 1-Hour OFF Timer**
 This timer can be set to automatically turn off the unit at any time after one hour.
- Night Setback**
 This function saves energy by controlling operation to provide a quieter operating sound than normal.
- Automatic and 3-step Fan Speed**
 Auto/High/Medium/Low
- Air Sweep Control**
 This function moves a flap up and down in the air outlet, directing air in a sweeping motion around the room and providing comfort in every corner.
- Automatic Restart Function for Power Failure**
 Even when power failure occurs, preset programmed operation can be reactivated once power resumes.
- Automatic Switching between Cooling and Heating**
 This unit automatically switches between cooling operation and heating operation according to the difference between the room temperature and the temperature setting.
 (This function is available only for "Single use" of COOL/DRY/HEAT Model.)
- Hot Start Heating System**
 Right from the start, the air is warm and comfortable. This system prevents any cold blasts at the beginning while the heat pump is warming up, or even defrosting.
 (This function is available only for COOL/DRY/HEAT Model.)

NOTE

- Since the wired remote controller is designed to be commonly used for various air conditioners, some of the functions of the wireless remote controller supplied with the indoor unit cannot be used.
- "Single use" means that only one indoor unit is connected with one outdoor unit in a one-unit-to-one-unit configuration.
- "Multiple use" (i.e. Flexi-Multi system) means that two or more indoor units are connected with one outdoor unit in a multiple-unit-to-one-unit configuration.

CONTENTS

	Page
FEATURES	2
PRODUCT INFORMATION	2
SAFETY PRECAUTIONS	2
INSTALLATION LOCATION	3
ELECTRICAL REQUIREMENTS.....	3
SAFETY INSTRUCTIONS	3
REMOTE CONTROLLER	4
OPERATION WITH THE REMOTE CONTROLLER.....	7
1. Automatic Operation (only for COOL/DRY/HEAT Model)	7
2. Manual Operation	7
3. Adjusting the Fan Speed	8
4. Fan Only	8
5. Night Setback Mode	8
SPECIAL REMARKS	8
SETTING THE TIMER.....	9
USING THE 1-HOUR OFF TIMER	10
ADJUSTING THE AIRFLOW DIRECTION	10

PRODUCT INFORMATION

If you have problems or questions concerning your wired remote controller, you will need the following information.

Model No. _____
 Date of purchase _____
 Dealer's address _____
 Phone number _____

SAFETY PRECAUTIONS

The following symbols used in this manual, alert you to potentially dangerous conditions to users, service personnel or the appliance:



WARNING

This symbol refers to a hazard or unsafe practice which can result in severe personal injury or death.



CAUTION

This symbol refers to a hazard or unsafe practice which can result in personal injury or product or property damage.

INSTALLATION LOCATION

We recommend that this wired remote controller be installed properly by qualified installation technicians in accordance with the Installation Instructions provided with the unit.



WARNING

- Do not install this wired remote controller where there are fumes or flammable gases, or in an extremely humid space such as a greenhouse.
- Do not install the wired remote controller where excessively high heat-generating objects are placed.

Avoid:

To protect the air conditioner from heavy corrosion, avoid installing the outdoor unit where salty sea water can splash directly onto it or in sulphurous air near a spa.

ELECTRICAL REQUIREMENTS

1. All wiring must conform to the local electrical codes. Consult your dealer or a qualified electrician for details.
2. Each unit must be properly grounded with a ground (or earth) wire or through the supply wiring.
3. Wiring must be done by a qualified electrician.

NOTE

Pull off the power plug from a receptacle, or switch off the breaker, or switch off the power disconnecting mean to isolate the air conditioner from the main power supply when not in use for a long time.



SAFETY INSTRUCTIONS

- Read this Instruction Manual carefully before using this air conditioner. If you still have any difficulties or problems, consult your dealer for help.
- This air conditioner is designed to give you comfortable room conditions. Use this only for its intended purpose as described in this Instruction Manual.







WARNING

- Confirm to authorized dealer or specialist on usage of specified refrigerant type. Using of refrigerant other than the specified type may cause product damage, burst and injury etc.
- Never touch the unit with wet hands.
- Never use or store gasoline or other flammable vapor or liquid near the air conditioner — it is very dangerous.
- Do not use this appliance in a potentially explosive atmosphere.
- This air conditioner has no ventilator for intaking fresh air from outdoors. You must open doors or windows frequently when you use gas or oil heating appliances in the same room, which consume a lot of oxygen from the air. Otherwise there is a risk of suffocation in an extreme case.
- Do not swallow the battery.
- After removing the battery from remote controller, keep it away from the reach of children. The battery can cause death by suffocation if swallowed.

- To prevent possible hazards from insulation failure, the unit must be grounded. 
- Do not clean inside the indoor and outdoor units by users. Engage authorized dealer or specialist for cleaning.
- In case of malfunction of this appliance, do not repair by yourself. Contact to the sales dealer or service dealer for a repair.
- Refrigerant gas leakage may cause fire.
- For safety, be sure to turn the air conditioner off and also to disconnect the power before cleaning. 
- Pull off the power plug from a receptacle, or switch off the breaker, or switch off the power disconnecting mean to isolate the air conditioner from the main power supply in case of emergency.



CAUTION

- Do not turn the air conditioner on and off from the power mains switch. Use the ON/OFF operation button.
- Do not stick anything into the air outlet of the outdoor unit. This is dangerous because the fan is rotating at high speed. 
- Do not touch the air inlet or the sharp aluminum fins of the outdoor unit. You may get injured. 
- Keep the fire alarm and the air outlet at least 1.5m away from the unit.
- Do not let children play with the air conditioner.
- Do not cool or heat the room too much if babies or invalids are present.
- Do not sit or step on the unit. You may fall down accidentally. 
- Do not stick any object into the FAN CASE. You may be injured and the unit may be damaged. 



NOTICE

- This device complies with part 15 of the FCC Rules. Operation is subject to the following two conditions: (1) This device may not cause harmful interference, and (2) this device must accept any interference received, including interference that may cause undesired operation.
- This equipment has been tested and found to comply with the limits for a Class B digital device, pursuant to part 15 of the FCC Rules. These limits are designed to provide reasonable protection against harmful interference in a residential installation. This equipment generates, uses and can radiate radio frequency energy and, if not installed and used in accordance with the instructions, may cause harmful interference to radio communications. However, there is no guarantee that interference will not occur in a particular installation. If this equipment does cause harmful interference to radio or television reception, which can be determined by turning the equipment off and on, the user is encouraged to try to correct the interference by one or more of the following measures:
 - Reorient or relocate the receiving antenna.
 - Increase the separation between the equipment and receiver.
 - Connect the equipment into an outlet on a circuit different from that to which the receiver is connected.
 - Consult the dealer or an experienced radio/TV technician for help.
- FCC Caution: To assure continued compliance, follow the attached installation instructions. Any changes or modifications not expressly approved by the party responsible for compliance could void the user's authority to operate this equipment.

REMOTE CONTROLLER

NOTE

The descriptions on the AUTO (Ⓐ) or HEAT (☀️) operation mode are only for the “COOL/DRY/HEAT Model,” and not for the “COOL/DRY Model.”

Display

Information on the operating conditions is displayed while the remote controller is switched on. If the unit is turned off, only the mode that was set previously is still displayed.

Temperature setting buttons (TEMP.)

Press the ▲ button to increase the set temperature.
 Press the ▼ button to reduce the set temperature.
 The temperature setting changes by 2 °F each time one of the TEMP. buttons is pressed.

FAN SPEED selector button

- Ⓐ 🌀 : The air conditioner automatically decides the fan speeds.
- 🌀 : High fan speed
- 🌀 : Medium fan speed
- 🌀 : Low fan speed

NIGHT SETBACK button

For details, see “5. Night Setback Mode”. When you press this button in the HEAT, DRY or COOL mode, the 🌙 mark appears in the display, and the remote controller will automatically adjust the set temperature to save energy.

FLAP button

Press this button either to select the setting of the airflow direction to one of the six possible positions manually or to select the sweep function which moves the flap up and down automatically.

- 🌀 : The airflow direction can be set manually. (six positions)
- 🌀 : The flap moves up and down automatically.

NOTE

When you press the FLAP button, the air flow direction will be changed one by one as follows.

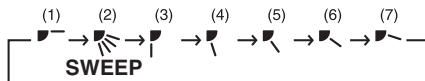

Timer and Present Time setting buttons

First, press the SET button to select the mode (ON, OFF and Present Time settings) you want.

Each time you press the “HH” button, the hours advance by one. (PM0, PM1.....PM11, AM0, AM1.....AM11)

Each time you press the “MM” button, the minutes advance by one when setting Present Time and by ten when setting ON and OFF Time.

SET button

For details, see “SETTING THE TIMER”.

Press this button to select the mode you want to program.

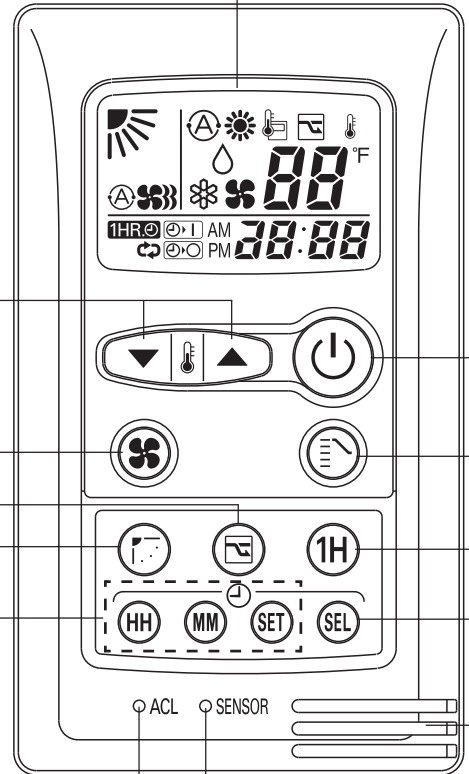

ACL button (ALL CLEAR)

When you press the ACL button while the operation button is ON, all settings are cleared. Press the ACL button if the air conditioner is not operating correctly.

ON/OFF operation button

This button is for turning the air conditioner on and off.

MODE selector button

Use this button to select AUTO, HEAT, DRY, COOL or FAN mode.

(AUTO)  : When this setting is selected, the air conditioner calculates the difference between the thermostat setting and the room temperature and automatically switches to the "COOL" or "HEAT" mode as appropriate. (This function is available only for "Single use" of COOL/DRY/HEAT Model.)

(HEAT)  : The air conditioner makes the room warmer.

(DRY)  : The air conditioner reduces the humidity in the room.

(COOL)  : The air conditioner makes the room cooler.

(FAN)  : The air conditioner works only as a circulation fan except for "Multiple use" of COOL/DRY/HEAT Model.

1 HR. TIMER button (1-HOUR OFF TIMER)

1HR  : When you press this button, regardless of whether the unit is operating or stopping, the unit operates for one hour and then shuts down.

TIMER SELECT button

No display : The timer does not operate.

 : The air conditioner starts at the set time.

 : The air conditioner stops at the set time.

 : The air conditioner stops and starts, or starts and stops, at the set times every day.

Sensor

A temperature sensor inside the remote controller senses the room temperature.

SENSOR button

When you press this button (use a small-tipped object such as a ballpoint pen), the  mark will disappear at the display. And the room temperature is detected by the sensor which is built into the remote controller and the air conditioner is controlled accordingly.

NOTE

If the remote controller is located near a heat source, such as a space heater or in direct sunlight, press the SENSOR button to switch to the sensor on the indoor unit.

NOTE

The indoor fan runs continuously when the system is in normal operation. It does not turn off when the desired room temperature is reached. If Night Set Back mode is selected, the fan will turn off intermittently during cooling operation in order to control air flow.

REMOTE CONTROLLER (DISPLAY)

Displayed when indoor unit sensor is in use

Displayed when operating NIGHT SETBACK mode

Displayed when setting temperature

Displayed when temperature is shown

Displayed when setting timer

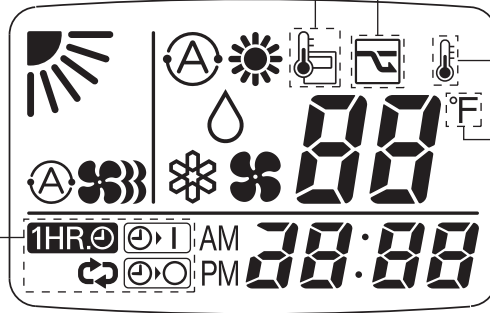

Symbols

(1) Operation mode

AUTO
(only for COOL/DRY/HEAT Model)
HEAT
(only for COOL/DRY/HEAT Model)



MILD DRY



COOL



FAN



(2) Fan speed

Automatic operation



HIGH



MEDIUM



LOW



(3) Temperature setting

60 – 86 °F



When set to 80 °F temperature indication



(4) Timer

24-hour clock with ON/OFF program Timer



ON Timer.



OFF Timer.



1-hour OFF Timer.



(5) NIGHT SETBACK



(6) Flap angle indication



Sweep indication



OPERATION WITH THE REMOTE CONTROLLER

1. Automatic Operation (only for COOL/DRY/HEAT Model)

- Single use
This unit automatically switches between cooling operation and heating operation according to the difference between the room temperature and the temperature setting.
- Multiple use
The air conditioner calculates the difference between the thermostat setting and room temperature, and automatically determines the mode to operate under cooling or heating. Then, the air conditioner continuously operates under the mode selected at initial operation.

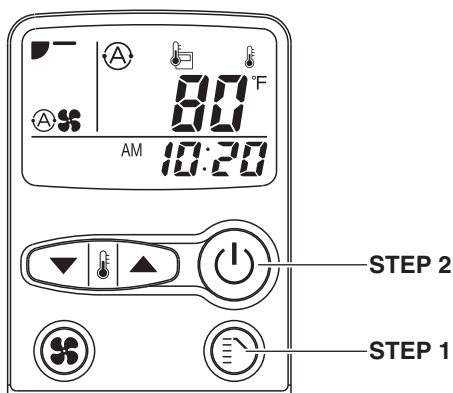

NOTE Check that the circuit breaker on the power panel is turned on.

Once mode is selected and the unit is preset by following the steps below, you can have the air conditioner automatically bring the room to the desired temperature simply by pressing the ON/OFF operation button.

STEP 1	Press the MODE selector button to .
STEP 2	Press the ON/OFF operation button.

To stop the air conditioner, press the ON/OFF operation button again.

NOTE To change the temperature setting; press the temperature setting buttons and change the setting to the desired temperature.

2. Manual Operation

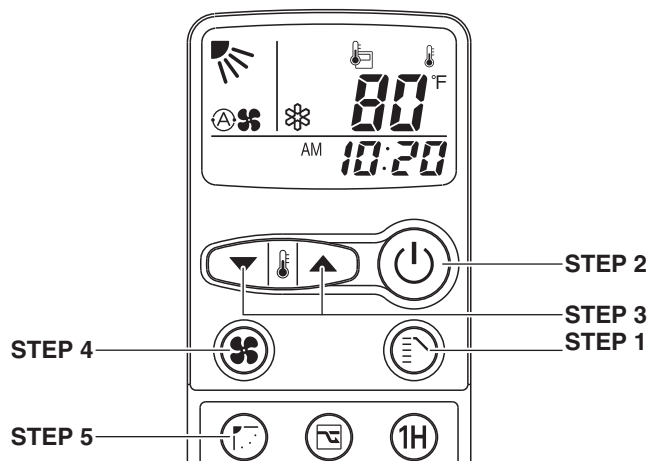

NOTE Check that the circuit breaker on the power panel is turned on.

If the automatic operation settings of the unit do not meet your needs, press the setting buttons as described below and change the settings as desired.

STEP 1	Press the MODE selector button and select the desired mode. For heating operation → For dehumidifying operation → For cooling operation → For fan only operation → (No Fan mode in "Multiple use" of COOL/DRY/HEAT Model)
STEP 2	To start the air conditioner, press the ON/OFF operation button.
STEP 3	Press the TEMP. setting buttons to change the temperature setting to the desired temperature. Adjustable temperature range: 86 °F max. 60 °F min.
STEP 4	Set the FAN SPEED selector button to the setting you want.
STEP 5	Press the FLAP button and set the airflow direction as desired. (Refer to "ADJUSTING THE AIRFLOW DIRECTION" on page 10.)

To stop the air conditioner, press the ON/OFF operation button again.

- NOTE**
- Choose the best position in the room for the remote controller, which also acts as the sensor for room comfort and transmits the operating instructions. Once you've found this best position, always keep the remote controller there.
 - This appliance has a built-in 5-minute time delay circuit to ensure reliable operation. When the operation button is pressed, the compressor will start running within three minutes. In the event of power failure, the unit will stop.
 - The display on the remote controller shows the setting temperature and not the room temperature.
 - When multiple indoor units are used and units in other rooms are already operating, they will be operating with the same mode as the operating indoor units. (only for "Multiple use" of COOL/DRY/HEAT Model)

EG

3. Adjusting the Fan Speed

A. Automatic fan speed

Simply set the FAN SPEED selector button to the position.

This automatically sets the best fan speed for the room temperature.

B. Manual fan speed

If you want to adjust fan speed manually during operation, just set the FAN SPEED selector button as desired. [, , or]

4. Fan Only

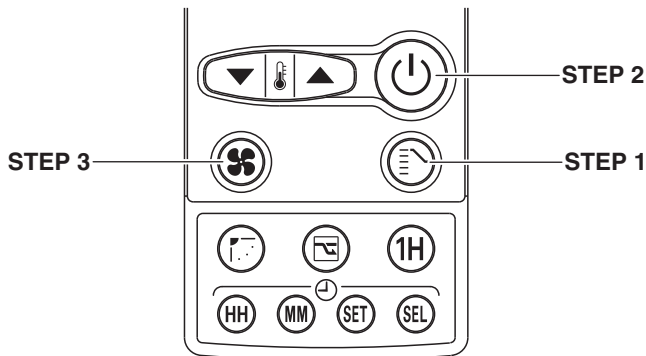

If you want to circulate air without any temperature control, follow these steps:

STEP 1	Press the MODE selector button to switch to the fan mode .
STEP 2	Press the ON/OFF operation button.
STEP 3	Press the FAN SPEED selector button to select the fan speed of your choice (, , or).

NOTE There is no FAN only function in "Multiple use" of COOL/DRY/HEAT Model.

5. Night Setback Mode

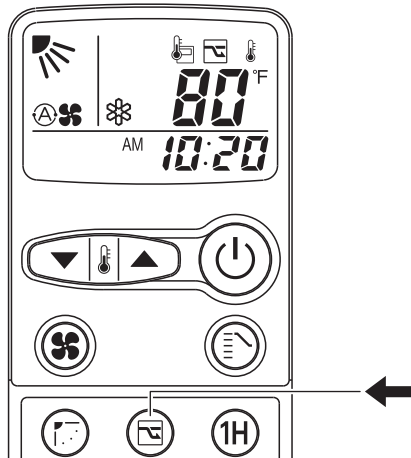

Night Setback Mode is used for saving energy.

Press the NIGHT SETBACK button while unit is operating. The mark appears in the display.

To release the night setback function, press the NIGHT SETBACK button again.

A. In Cooling and DRY Mode: (and)

When the night setback mode is selected, the air conditioner automatically raises the temperature setting 2 °F when 30 minutes have passed after the selection was made, and then another 2 °F after another 30 minutes have passed, regardless of the indoor temperature when night setback was selected. This enables you to save energy without sacrificing comfort. This function is convenient when gentle cooling is needed.

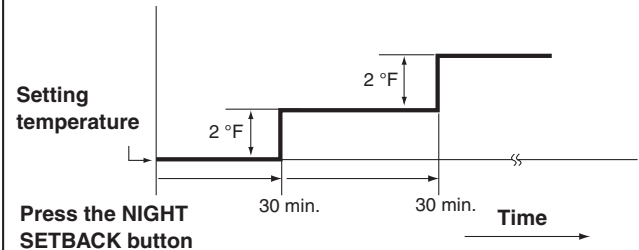

B. In Heating Mode: () (only for COOL/DRY/HEAT Model)

When the night setback mode is selected, the air conditioner automatically lowers the temperature setting 4 °F when 30 minutes have passed after the selection was made, and then another 4 °F after another 30 minutes have passed, regardless of the indoor temperature when night setback was selected. This enables you to save energy without sacrificing comfort. This function is convenient when gentle heating is needed.

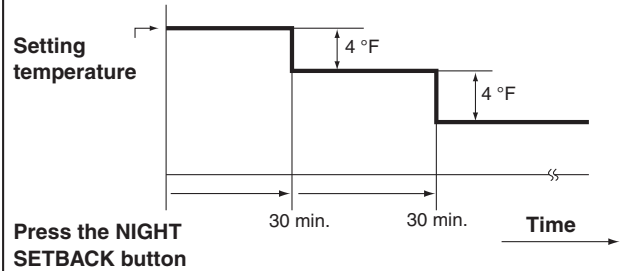

SPECIAL REMARKS

Power failure during operation

In the event of power failure, the unit will stop. When the power is resumed within 8 hours, the unit will restart automatically in approximately five minutes, or 15 minutes in "Multiple use" of COOL/DRY/HEAT Model on AUTO mode by the remote controller.

Remote Controller

The remote controller sends the setting condition to the air conditioner regularly at five minute intervals.

Remote Controller Display

If the display malfunctions, press the ACL button. This resets the remote controller back to the initial settings. Make the settings again.

SETTING THE TIMER

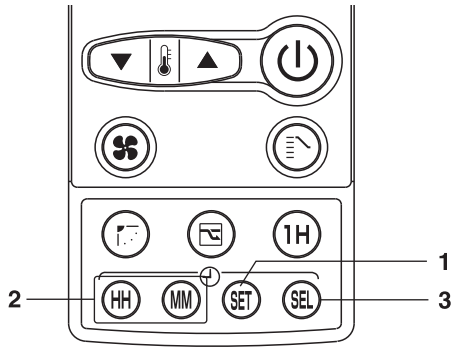

1. How to set the present time

(Example) To set to 9:10 pm.

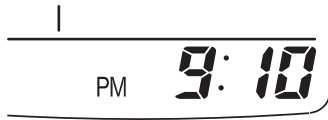

Operation	Indication
1. Press the SET button three times.	The time indication alone flashes.
2. • Press the HH button until PM 9 is displayed. • Press the MM button until 10 is displayed.	The display will flash for 10 sec. and automatically stop flashing except for the “:” symbol.

2. How to set the OFF time

(Example) To stop the air conditioner at 11:30 pm.

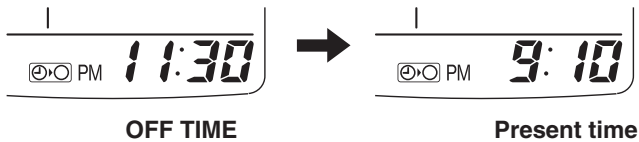

Operation	Indication
1. Press the SET button twice.	The timer indication alone flashes and the previous set-time is only displayed.
2. • Press the HH button until PM 11 is displayed. • Press the MM button until 30 is displayed.	The display will change automatically back to show the present time after about 10 sec.
3. Press the TIMER SELECT button twice to set OFF time.	The present time and are displayed.

To cancel the setting, press the TIMER SELECT button twice.

3. How to set the ON time

(Example) To start operation at 7:10 am.

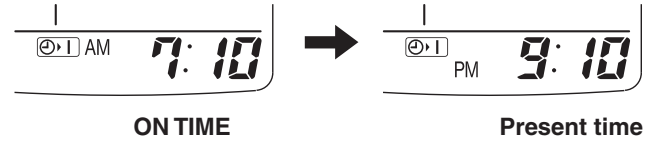

Operation	Indication
1. Press the SET button once.	The timer indication alone flashes and the previous set-time is only displayed.
2. • Press the HH button until AM 7 is displayed. • Press the MM button until 10 is displayed.	The display will change automatically back to show the present time after about 10 sec.
3. Press the TIMER SELECT button once to set ON time.	The present time and are displayed.

To cancel the setting, press the TIMER SELECT button three times.

4. How to set daily ON/OFF repeat timer

(Example) To start operation at 7:10 am. and stop the air conditioner at 11:30 pm.

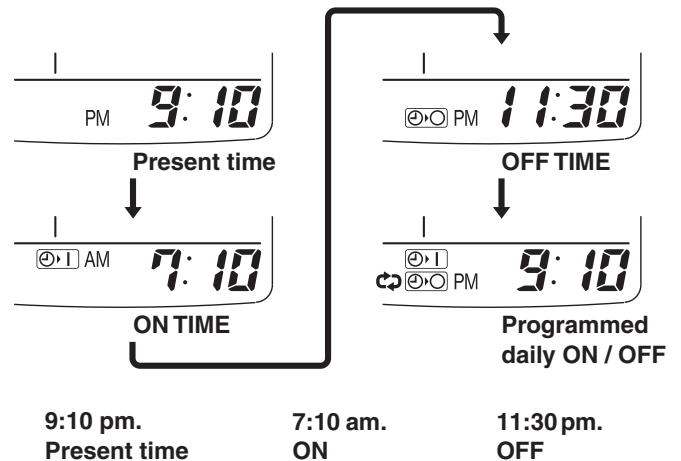

Operation	Indication
Set the timer ON/OFF times as shown in 2 and 3.	The present time PM 9:10 and are displayed.

To cancel the setting, press the TIMER SELECT button once.

NOTE

You can check the timer ON/OFF times after you have set them by pressing the SET button.

5. Backup function

Even if the main power supply to the unit is turned off, the remote controller will store the previous settings in its internal memory for up to 8 hours. If the power is not turned back on within 8 hours, the previous settings will be lost. In this case, the mode settings must be reset by the user.

USING THE 1-HOUR OFF TIMER

1. 1-Hour OFF Timer

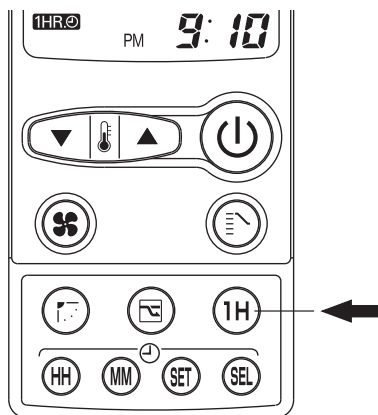

This function causes the unit to operate for one hour and then stop, regardless of whether the unit is on or off when this button is pressed.

The **1HR** indicator in the display indicates that this function is operating.

Setting procedure:

Regardless of whether the unit is operating or stopped, press the 1 HR. TIMER button.

1HR appears in the display.

Cancellation procedure:

Press the ON/OFF operation button to turn the unit off, wait for the unit to stop operating, and then press the ON/OFF operation button again.

The 1-Hour Timer function is now cancelled and the unit operates normally.

NOTE

- If, while the 1-Hour Timer function is operating, the 1HR. TIMER button is pressed once to cancel the function and then again, the unit continues to operate for one hour from that point in time and then stops.
- It is not possible to use the OFF Timer and 1-Hour OFF Timer together. Whichever function is set last takes precedence. If the 1 HR. TIMER button is pressed while the TIMER OFF function operates, the OFF Timer is cancelled and the unit will stop operating one hour later.

2. Operation together with the daily ON/OFF repeat timer

The 1-Hour OFF Timer setting is given priority over the DAILY ON/OFF REPEAT setting.

ADJUSTING THE AIRFLOW DIRECTION

The vertical airflow can be adjusted by moving the flap with the remote controller. Do not move the flap with your hands. Confirm that the remote controller has been turned on. Use the FLAP button to set either the sweep function or one of the six airflow direction settings.

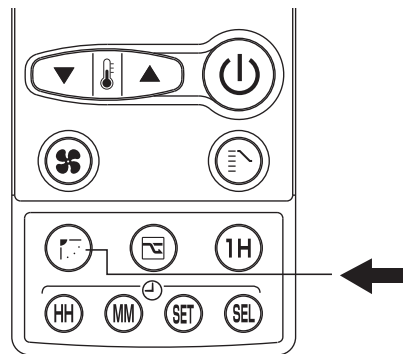

A. Sweep function



The flap starts moving up and down to deliver air over the sweep range.

B. Setting the airflow manually



Referring to the above illustration, use the FLAP button to set the airflow direction within the range used during the heating, cooling, or dehumidifying operation.

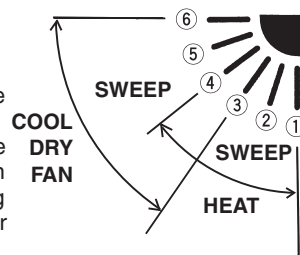

NOTE

- The flap automatically closes when the unit is off.
- During the heating operation, the fan speed will be very low and the flap will be in the horizontal position (position ⑥) until the air being blown out of the unit begins to warm. Once the air warms up, the flap position and fan speed change to the settings specified with the remote controller.



CAUTION

- Use the FLAP button on the remote controller to adjust the position of the flap. If you move the flap by hand, the flap position according to the remote controller and the actual flap position may no longer match. If this should happen, shut off the unit, wait for the flap to close, and then turn on the unit again; the flap position will now be normal again.
- Do not have the flap pointed down during cooling operation. Condensation may begin to form around the air vent and drip down.

APPENDIX D INSTALLATION INSTRUCTIONS

CZ-RD515U

(852-6-4190-592-00-0)

INSTALLATION INSTRUCTIONS

Wired Remote Controller



IMPORTANT

- In order to install this wired remote controller onto a wall-mounted model, the connection kit (CZ-RC515U or CZ-RC515UA), which must be purchased separately, is required.
- Once the wired remote controller is connected, the wireless remote controller cannot be used.

Parts supplied with the remote controller

See Table 1.

Remote controller installation guidelines

Installation location

- Mount the remote controller 3.3 to 4.9 ft. (1 to 1.5 meters) off the floor where it can sense the average temperature of the room.
- Do not mount the remote controller in a place exposed to direct sunlight or where it is exposed to outside air such as near a window.
- Do not mount the remote controller behind a curtain or other object so that it is separated from the air circulation of the room.
- Mount the remote controller inside the room being air conditioned.

Switching the room temperature sensor

Room temperature sensors are separately incorporated in both the indoor unit and the remote controller. Either sensor can be used to sense the room temperature. The indoor unit sensor is usually used.







If you wish the remote controller to sense the room temperature, press the SENSOR button with a ballpoint pen or tool with a small tip. (Refer to Fig. 9 on page 4 to locate the SENSOR button.)

How to install the remote controller

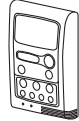
IMPORTANT

- The remote controller is set to “Cool/Dry/Heat model” at the time of shipment from the factory. If the purchased air conditioner is a COOL/DRY model, follow the instructions on the label and change the switch on the reverse side of the remote controller unit to “Cool/Dry model”. (Fig. 1)
- The remote controller is also set to “Single” at the time of shipment from the factory. For multiple use, set the switch on the reverse side of the remote controller unit to “Multi”. (Fig. 1)
- After all work is completed, if any switches have been changed, then be sure to press the ACL (Reset) button. (Refer to Fig. 9 on page 4 to locate the ACL (Reset) button.)

Table 1

Parts	Figure	Q'ty	Parts	Figure	Q'ty
Wired remote controller		1	Wire harness		1
Machine screws		2	Instruction manual		1
Tapping screws		2	Installation Instructions		1
Spacers		2			

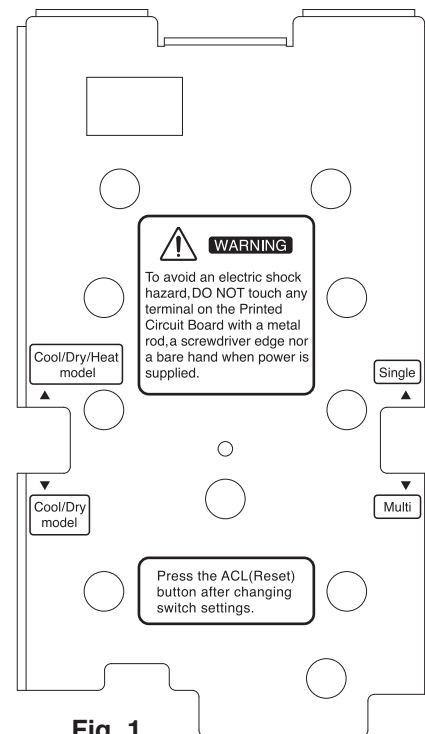

Fig. 1

A. Installing with in-wall junction box

- (1) Install the junction box (locally purchased) into the wall. (Figs. 2-a and 3)
- (2) Pass the wire harness through the junction box and conduit. (Fig. 3)
- (3) Insert a flathead screwdriver into the 5 tab locations and disconnect the back plate of the remote controller by lifting up slightly. (Fig. 2-b)
The tabs are thin; take care not to chip them.
- (4) Pass the wire harness connector through the cord opening on the back plate of the remote controller.
Use nippers or a similar tool to cut out the slots for the remote controller back plate screws. Insert the spacers and use the machine screws to install the remote controller back plate. (Fig. 3)
- (5) Insert the connector into the PCB of the remote controller unit, and wrap the wire harness around the hook. (Fig. 4)
- (6) Store the excess wire harness inside the junction box, then hook the remote controller unit onto the top of the back plate and install the remote controller unit.
- (7) To remove the remote controller unit after it has been installed, insert a flathead screwdriver into the slot on the bottom of the case and turn it. (Fig. 5)

B. Installing directly onto the wall

- (1) Insert a flathead screwdriver into the 5 tab locations and disconnect the back plate of the remote controller by lifting up slightly. (Fig. 2-b)
The tabs are thin; take care not to chip them.
- (2) Use tapping screws to directly fasten the remote controller back plate onto the wall. (Fig. 6)
- (3) Insert the connector into the PCB of the remote controller unit, and wrap the wire harness around the hook. (Fig. 4)
- (4) Use nippers or a similar tool to cut out the slot on the top of the remote controller unit. Pass the wire harness through the slot, then hook the remote controller unit onto the top of the back plate and install the remote controller unit.
- (5) In order to conceal the exposed wiring, use a wire cover (locally purchased) or similar means.

NOTE

- When installing the remote controller back plate, be sure that it is flat and straight. Do not over-tighten the installation screws.
- Install the remote controller away from all sources of electrical noise.
- Install a noise filter or take other appropriate action if electrical noise affects the power supply circuit of the unit.

In-wall junction box (locally purchased)

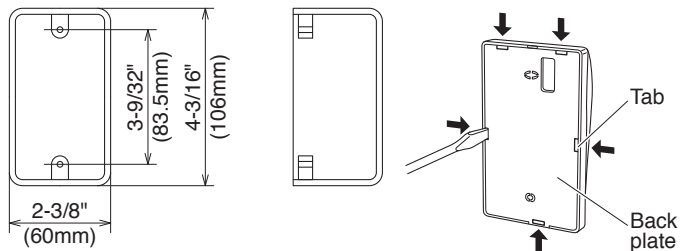

Fig. 2-a

Fig. 2-b

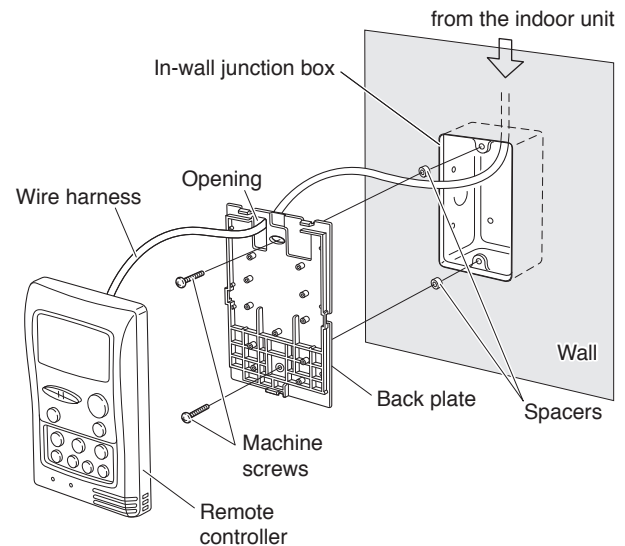

Fig. 3

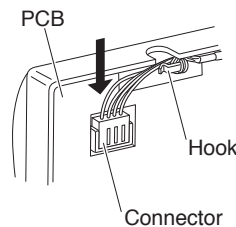

Fig. 4

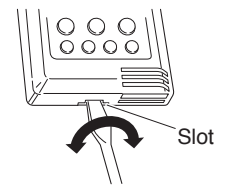

Fig. 5

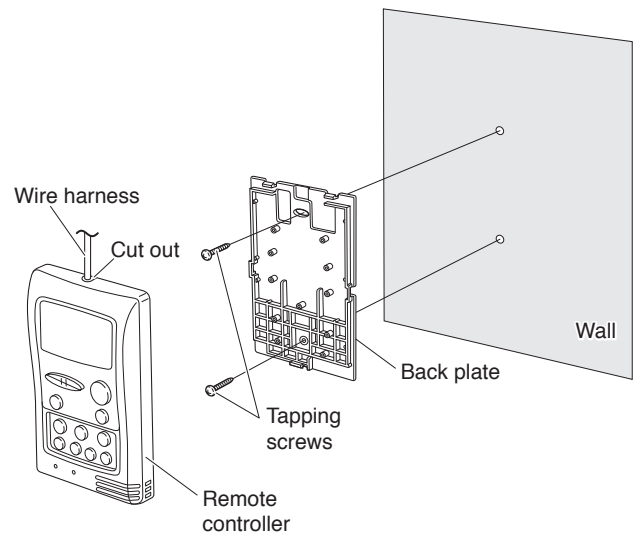

Fig. 6

■ How to wire the remote controller

- (1) Turn OFF the power and remove the ceiling panel air-intake grille. (Refer to **3-6-1 Before Installing the Ceiling Panel** in the Installation Instructions supplied with the indoor unit.)
- (2) Remove the 3 power box cover screws and 2 control box cover screws, then remove both covers. At this time, take care not to drop the covers. (Fig. 7)
- (3) Disconnect the 7P (IND) terminal and 4P (RC) terminal of the 7P IND and 4P RC wiring connectors and the 5P terminal of the 5P FLAP wiring connector from the control box PCB connectors (IND, RC, FLAP). Disconnect each wiring connector from the clamp that fastens it. (Fig. 7)
- (4) Remove the ceiling panel. (To remove the ceiling panel, follow the steps for **3-6 How to Install the Ceiling Panel** in the reverse order. Refer to the Installation Instructions supplied with the indoor unit.)

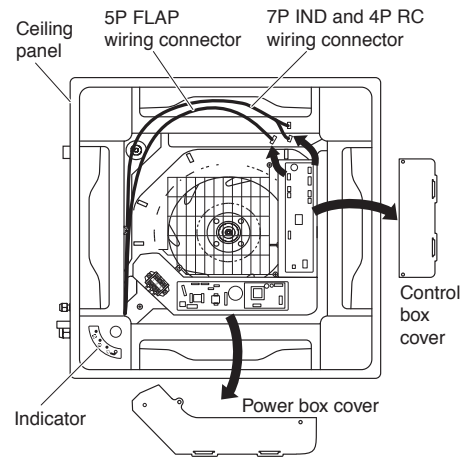

Fig. 7

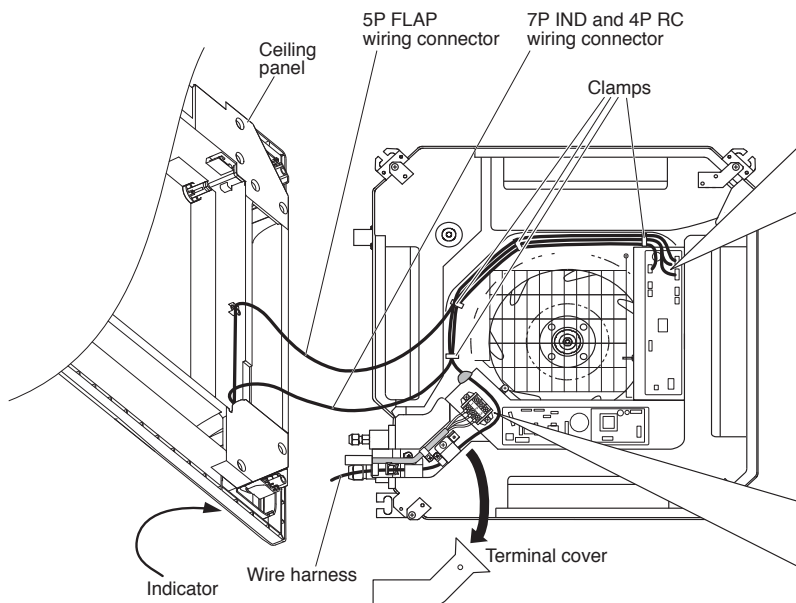

Fig. 8

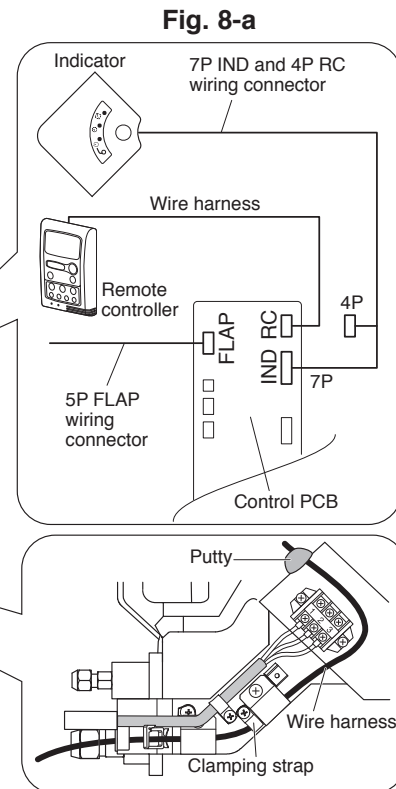

Fig. 8-a

Fig. 8-b

- (5) Remove the terminal cover screws, then remove the cover. At this time, take care not to drop the cover. (Fig. 8)
- (6) Pull in the wire harness from the remote controller as shown in Fig. 8-b.
 - Remove the putty before wiring. After wiring, make sure to restore the putty.
- (7) Insert the wire harness 4P terminal into the control box PCB connector (RC). (Fig. 8-a)
- (8) Install the terminal cover. Then install the ceiling panel. (Refer to **3-6 How to Install the Ceiling Panel** in the Installation Instructions supplied with the indoor unit.)
- (9) Insert only the 7P (IND) terminal of the 7P IND and 4P RC wiring connector into the connector (IND) on the control box PCB. Store the 4P terminal inside the control box. (Fig. 8-a)
- (10) Next, insert the 5P terminal of the 5P FLAP wiring connector into the connector (FLAP) on the control box PCB. (Fig. 8-a)
- (11) When the connections are completed, fasten the wire harness and each wiring connector with the clamps.
- (12) Install the power box cover and control box cover.
- (13) Install the air-intake grille. (Refer to **3-6 How to Install the Ceiling Panel** in the Installation Instructions supplied with the indoor unit.)

■ How to Test Run the Air Conditioner

After turning on the power of the air conditioner, use the remote controller and follow the steps below to conduct the test run.

- (1) Set the remote controller in Test Run mode. (Fig. 9)
 - a) Press and hold the NIGHT SETBACK button and the 1HR. TIMER button.
 - b) Then press and hold the ACL (Reset) button with a pointed object such as the tip of a pen. After 5 seconds, release the ACL button first.
 - c) Then release the NIGHT SETBACK and 1HR. TIMER buttons.
 - d) ❄ appears and “oP-1” blinking in the remote controller clock display area. (Fig. 10)
- (2) Start Cooling mode test run by pressing the ON/OFF operation button of the remote controller. (Fig. 9)
 - This starts the fan producing uncooled forced air with the 3 indicator lamps (OPERATION lamp, TIMER lamp, and HIGH POWER lamp) on the main unit blinking. (Fig. 11)
 - After 3 minutes, the system shifts into cooling operation, and cool air will start to be felt. Cooling mode test run is unaffected by the room temperature.
- (3) Press the ON/OFF operation button of the remote controller again to stop the test run. (Fig. 9)
- (4) Finally press the ACL (Reset) button of the remote controller to release it from Test Run mode to return to normal mode. (Fig. 9)
 - “❄” and “oP-1” will disappear from the remote controller clock display area.

NOTE

Troubleshooting:

In the event that the green OPERATION lamp is blinking upon powering up the system, an error condition exists. In this case, refer to the self-diagnostics procedure which can be seen by opening the air-intake grille.

IMPORTANT

After the test run is completed, be sure to press the ACL (Reset) button to return to normal mode. The air conditioner will not operate correctly if this is not done.

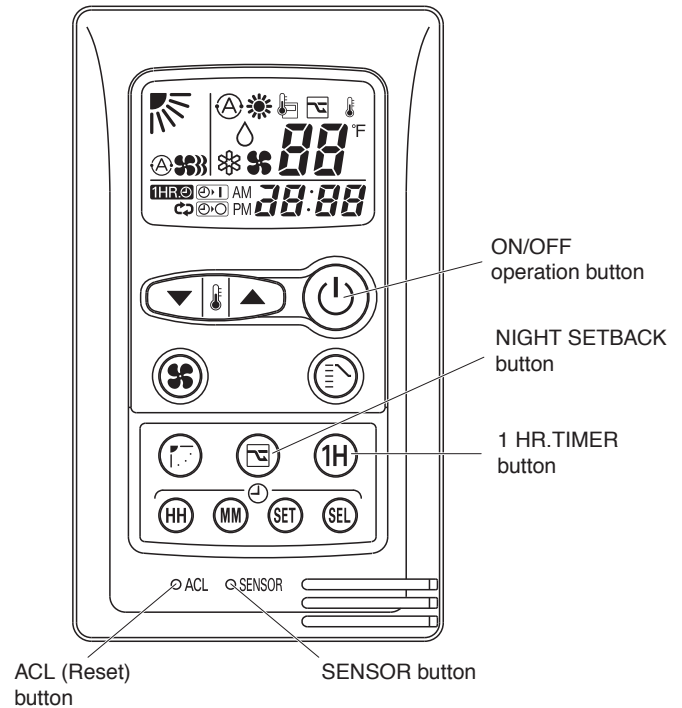

Fig. 9

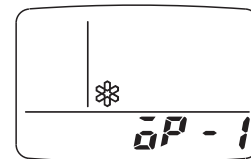

Fig. 10

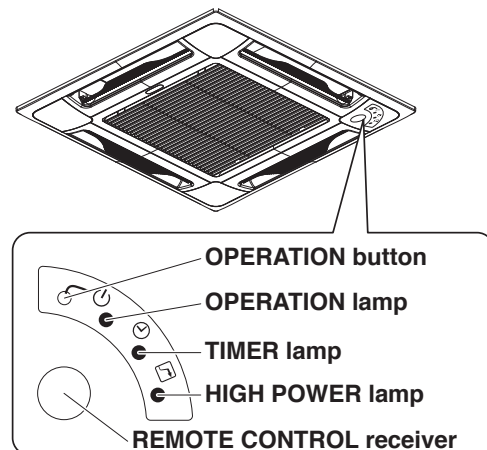

Fig. 11

WI1011-0

Printed in China

