

Installation Instructions

iQ Drive Split System Heat Pump

The iQ Drive heat pump operates as part of a larger intercommunicating system which provides temperature, air flow, and humidity control for a residence or other similarly sized building. This system includes this outdoor unit, the dedicated iQ controller (thermostat), and an iQ system-compatible indoor unit, typically an air handler with electric strip heat or a gas furnace. The system will function only if these components are matched and intended for use within this system. A complete list of compatible equipment by model and serial number is available in NORDYNE document 709031, iQ Field Wiring Installation Instruction. Accessory equipment which may be used with this system includes humidifiers, electric or electronic air cleaners, and U/V (ultraviolet) sterilizing lamps.

Refer to the System Operation section below for a complete description of how to use the various features of the system. In addition to providing the means for operation, the controller also serves as the means for initial system configuration and setup, and it provides a considerable amount of information for troubleshooting the system and diagnosing problems.



OTHER REFERENCE DOCUMENTS

- Installation instruction documents for indoor equipment (furnace or air handler, optional humidifier, etc.)
- iQ Field Wiring Installation Instruction, document 709031, provided in the iQ thermostat/controller kit
- iQ Thermostat/Controller User's Manual, document 709063, provided in the iQ thermostat/controller kit
- local wiring and building codes
- Nordyne Application Guideline for Refrigerant Lines Over 75 Feet document 044B-0600
- iQ Zone System Zone Thermostat User's Manual
- iQ Zone System Installation Instructions

TABLE OF CONTENTS

PREPARATION	3
Slab Mounting	3
Roof Mounting.....	3
ELECTRICAL CONNECTIONS	3
Electrical Power Wiring	3
Control Circuit Wiring	4
iQ Zone Control Wiring	4
Recheck Wiring.....	4
REFRIGERANT LINE CONNECTIONS	4
Line Design and Routing.....	4
Brazing.....	5
System Evacuation	5
Refrigerant Charging.....	5
Alternate Procedure for Charging a Heat Pump in Cooling Mode	6
Alternate Procedure for Charging a Heat Pump in Heating Mode	6
SYSTEM SETUP USING THE IQ CONTROLLER	6
General	6
Screen Navigation.....	6
The Main Screen.....	6
Installer Settings	7
System Configuration	7
Accessories	8
Defrost Configuration	8
Dealer Information.....	8
Heat Off Delay	9
Altitude Adjust	9
Service Tests	9
SERVICE INFORMATION Screens	10
Other Configuration Entries	11
Minimum Heat Pump Operating Temp	11
Auto Changeover Time	12
Date and Time	12
Program Schedule vs. Nonprogrammable.....	12
Dehumidification.....	12
Humidity Settings	12
Smart Recovery	13
Zone Control.....	13
System Operation: Quick Start.....	14
System Startup, Checkout, & Troubleshooting.....	15
SYSTEM DIAGNOSIS & TROUBLESHOOTING	16
Controller	16
Outdoor Unit Inverter	16
Outdoor Unit Interface Board (right side small circuit board)	16
Outdoor Unit EXV Board (left side small circuit board)	17
Indoor Unit Interface Board (in G6 iQ furnace kit or air handler)	17
Indoor Unit EXV Board.....	17
Indoor Unit Constant CFM Motor Control Board.....	17
Indoor Unit One or Two-Stage G7 Furnace Board	17
Indoor Unit iQ Modulating Gas Furnace Board.....	17
Airzone Control Board.....	17
iQ Zone System Configuration.....	18
Common Troubleshooting Issues.....	18
MAINTENANCE	19
FIGURES & DIAGRAMS	19

PREPARATION

Before proceeding with installation of iQ heat pump equipment, consult with the distributor and homeowner to confirm that the equipment listed on the order is what was ordered, and that it matches labeling on the equipment packaging.

Next determine (including consultation with the homeowner) the intended/preferred location for placement of the compressor/outdoor coil unit. Unit envelope dimensions are shown in Figure 1.

This heat pump is designed for outdoor installation only. Unit placement must take into consideration the following clearances: (a) A minimum of 18 inches must be provided between each of the four sides and any solid barrier or wall which might block free inlet air flow into the coil. A minimum clearance of 36 inches is required between multiple units. (b) The corner of the unit covered by the control access cover must be clear enough to allow comfortable access by a serviceperson. (c) The top of the unit must be open and unobstructed to prevent recirculation of outdoor fan discharge air, particularly for air conditioning usage. A minimum distance of 4 feet overhead clearance is recommended. Do not locate the unit in a pit with high walls on all sides.

Locate the unit away from overhangs which would allow water runoff or ice to fall directly onto the heat pump. Avoid placing the unit near sidewalks or walkways to avoid possible icing from defrost cycles. In low temperature climates, place the unit where it is not directly in prevailing winds. Avoid placing the heat pump near sleeping quarters or windows. As the unit goes through defrost cycles, a change in sound will occur.

Slab Mounting

The preferred unit mounting is on an outdoor slab (concrete or plastic), on the ground, in an area with good drainage unlikely to be affected by heavy runoff, ground settling, or deep snowdrift accumulation. The support slab should be level. If the area is subject to heavy snowfall or drift accumulation, the use of a snow stand is recommended as well. Make sure that the drain holes in the bottom of the unit are not obstructed.

Roof Mounting

The method used for roof mounting should be designed so as not to overload roof structures nor transmit noise to the interior of the structure. Refrigerant and electrical lines should be routed through suitably waterproofed openings to prevent leaking into the structure. Make sure that the roof structure can adequately support the weight of the equipment. Consult local building codes for rooftop installations.

After a location has tentatively been selected, trace routing of new (or pre-existing) refrigerant lines (two), and power and control wiring. See further discussion below.

- Maximum recommended length for refrigerant lines: 100 ft.
- Maximum elevation difference, compressor base to indoor coil base (compressor higher): 50 feet **NOTE:** An oil trap is required for elevations exceeding 50 feet.
- Maximum elevation difference, compressor base to indoor coil base (compressor lower): 50 feet **NOTE:** An oil trap is required for elevations exceeding 50 feet.

- Refrigerant lines should NOT be buried. (in concrete or otherwise)
- Refer to Nordyne Application Guideline for Refrigerant Lines Over 75 Feet document 044B-0600, for piping details

Once the above information has been confirmed and potential questions regarding location, refrigerant line routing, and wire routing have been resolved, proceed with unpacking the equipment. It is strongly recommended that inspection of the hardware be performed prior to bringing it to the installation site. Inspect for cosmetic as well as functional damage (such as obvious holes or gaps in tubes and joints, cut or pinched wires or wire insulation).

Verify that the iQ Drive® heat pump unit package includes the following:

- Coil/compressor/control unit.
- Packet containing installation instructions and one filter-drier.

NOTE: The thermostat/controller which is required for system operation is part of a separately purchased kit.

ELECTRICAL CONNECTIONS

WARNING:

ELECTRIC SHOCK HAZARD

Disconnect all electrical power at main circuit box before wiring electrical power to the outdoor unit. Failure to follow these instructions may result in electric shock or death.

Electrical Power Wiring

Electrical power wiring shall comply with the current provisions of the National Electrical Code (ANSI/NFPA 70) as supplemented by applicable local building codes. The installer should become familiar with the wiring diagram before making electrical connections to the outdoor unit. An equipment wiring diagram is included in this instruction and inside the unit control panel cover. Refer to the unit rating label located on the exterior of the control box cover for operating voltage, minimum circuit ampacity, and maximum fuse size. See Table I for wire sizing.

COPPER WIRE SIZE - AWG (1% Voltage Drop)				
Supply Circuit Ampacity	Supply Wire Length - Ft			
	up to 50	51 - 100	101 - 150	151 - 200
15	14	10	8	6
20	12	8	6	4
25	10	8	6	4
30	10	6	4	4
35	8	6	4	3
40	8	6	4	3
45	6	4	3	2
50	6	4	3	2

Wire Sized based on N.E.C. for 60°C type copper conductors

Table 1. Copper Wire Ampacity Tables

- A properly sized branch circuit and disconnect switch must be installed where it is easily accessible and within line of sight of the outdoor unit.
- Remove the control panel cover. Route the power and ground wires (3 wires, including earth ground) from the disconnect box to the unit. Use of outdoor shielded conduit (metal lined Sealtite®) is required. The electrical conduit opening is located on the lower left corner of the control box.
- Connect the power wires to L1 and L2 box lugs of the contactor, and the ground wire to the grounding lug to the left of the contactor. See Figures 2 and 3. Only copper wires should be used.
- Replace the control panel cover before applying power.

Control Circuit Wiring

The heat pump is designed to operate with a 24 VAC Class II control circuit. Control circuit wiring must comply with the latest version of the National Electrical Code (ANSI/NFPA 70) as supplemented by local building codes.

In general, 24 VAC control power and communication bus wiring must be run to interconnect the thermostat/controller, the indoor unit, and the outdoor unit. The “hub” of this network and source of the 24 VAC is located within the indoor unit (air handler or furnace). Refer to iQ Drive System Field Wiring Instructions, NORDYNE document 709031 shipped with the controller, for connection of control wires to the indoor unit and for description of other indoor field wiring, including to the controller.

Five (5) wires must be run between the indoor unit and the outdoor unit (2 for 24 VAC power and 3 for communications). Use one shielded cable (3 or more conductors) for communications only, and a separate cable or pair of wires for control power. Refer to wiring diagram Figure 4 and Table II.

1. Pass the 5 control wires into the hole in the lower right side of the control panel of the outdoor unit, into the separate low voltage wiring compartment. See Figures 5 and 6.
2. Locate the 5 corresponding factory-wired leads with stripped ends. Assure that each of these 5 wires (on the factory wiring side of the wire connections) loops around and through the “donut” (toroidal choke). Refer to Figure 7 which shows one wire making a single loop.
3. Connect each of the 5 field-run wires to its factory-wired counterpart using a wire nut, as indicated in Figures 4, 5 and 6.
4. Replace the control panel cover before applying power.

⚠ IMPORTANT

It is critical that the wires meant to connect to 24 vac control power (RED & GRAY) are not mistakenly connected to the communication bus wires (YEL, WHT, GRN). 24 volts applied to the communication bus will damage the equipment.

Communication Wiring			
Indoor Interface Board Terminal	Indoor Interface Board plug wire color	Outdoor unit wire color	Outdoor Interface Board Terminal (RHS circuit board)
DX+	YEL	YEL	3 pin 3 wire white connector plug at RHS circuit board terminal “INDOOR”
DX-	WHT	WHT	
GND	GRN	GRN	

Control Power Wiring			
R (screw)	[no factory wire]	RED	“R” terminal screw
C (screw)	[no factory wire]	GRY	(contactor coil, RHS)

Table 2. Control Wiring to Outdoor iQ Heat Pump Unit

iQ Zone Control Wiring

For iQ Zone systems, field wiring is required to connect the Airzone control board to the iQ communication bus and to provide a ground connection for the separate zoning control and communication network. Refer to the iQ Field Wiring Instruction document provided in the iQ controller kit for more details. A 3-wire cable must be run from a splice point in the iQ communication bus to the one 3-pin connector on the Airzone control board.

Recheck Wiring

Check that wire routing is correct and connections are secure for all power and control wiring.

REFRIGERANT LINE CONNECTIONS

Line Design and Routing

Refrigerant lines must be connected by a licensed EPA certified technician following sound established installation practice. Once the heat pump location has been determined and the unit set in place the refrigerant lines should be routed and connected.

- Refrigerant lines should follow a direct path from the indoor coil to the outdoor unit avoiding sharp bends. When lines pass through walls, make sure to properly seal and support them so that vibration is not transmitted to the structure.
- Refrigerant tubing should be supported in a manner which assures that the tubing will not vibrate or wear as a result of contact with sharp materials or edges during system operation.
- Lines must be clean refrigeration-grade copper.
- Avoid removing caps and plugs from the heat pump or lines until they are ready to be connected.
- Insulate the vapor line with refrigerant line insulation ¼” wall thickness or greater.

Proper system performance and oil management depend on properly selecting the liquid and vapor line sizes. Refer to Table III for the proper size of field supplied lines. The maximum allowable refrigerant line length is 100 ft.

Line Set Length	Vapor Line				Liquid Line
	up to 24 ft.	25 to 39 ft.	40 to 75 ft.	75 to 100 ft.	up to 100 ft.
-024K Units	3/4 in. (19 mm)	3/4 in. (19 mm)	7/8 in. (22 mm)	1 1/8 in. (29 mm)	3/8 in. (10 mm)
-036K Units	7/8 in. (22 mm)	7/8 in. (22 mm)	1 1/8 in. (29 mm)	1 1/8 in. (29 mm)	3/8 in. (10 mm)
-048K Units	7/8 in. (22 mm)	1 1/8 in. (29 mm)	1 1/8 in. (29 mm)	1 1/8 in. (29 mm)	3/8 in. (10 mm)

Table 3. Permissible Refrigerant Line Sizes

The maximum vertical elevation between the heat pump and indoor coil is 50 ft. Systems that require more elevation will need to have an oil trap installed in the vapor line. Refer to Nordyne Application Guideline for Refrigerant Lines Over 75 Feet (document 044B-0600) for piping details.

A filter drier is supplied with the heat pump. It is required and recommended that it be installed near the indoor coil.

It is recommended to replace existing refrigerant lines that were previously used for an R-22 system. If the lines are not replaced, they must be properly flushed by a licensed EPA certified technician in accordance with the manufacturer's instructions and established procedures.

Brazing

Use the appropriate safety equipment while brazing. Items such as gloves, safety glasses, proper ventilation, and a fire extinguisher should be used.

1. Route the refrigerant lines from the indoor coil to the service valves on the heat pump. Avoid sharp radius bends and turns.
2. Make sure that the vapor line is properly insulated for the entire length of the run for maximum system efficiency. Improper insulation may also create condensation and result in water damage to the equipment and building structure.
3. Remove the valve cores from the heat pump service valves. Wrap the valves completely with wet rags to protect them from overheating during the brazing operation.
4. Connect both the vapor and liquid lines. Tubes should be round, de-burred and free of debris. Use a phosphorous and copper or silver brazing alloy for the joints. Do not use soft solder with a low melting point.
5. Connect the indoor lines according to the indoor unit instructions. The indoor coil will require the same alloys and wet rags to protect the sensors from excessive heat on the refrigerant lines.
6. Allow the service valves to cool and replace the valve cores.
7. Leak test the connections using low pressure dry nitrogen.

System Evacuation

1. Connect the refrigerant gauge manifold to both the vapor and liquid service valves. See Figure 8. Connect the center port to the vacuum pump.
2. Open both manifold valves and start the vacuum pump. After a short time, it is recommended to close the manifold

valves and stop the vacuum pump to look for a rapid loss of vacuum. Loss of vacuum indicates that there is a leak in the system. Repeat the leak test if required.

3. Evacuate the system to at least 500 microns to remove non-condensables and water vapor. Close the manifold valves and remove the vacuum pump.
4. Connect the refrigerant tank to the center manifold port of the gauge set. Pressurize the system enough to break the vacuum.
5. Open both service valves by turning the valve stems ¼ turn counterclockwise. The stem will be in line with the tubes. Replace the stem caps and tighten. Proceed with Refrigerant Charging section.

WARNING:

The heat pump system contains liquid and gaseous refrigerant under pressure. Adjustment of refrigerant charge should only be done by a qualified, EPA certified technician thoroughly familiar with this type of equipment. Under no circumstances should the homeowner attempt to install and/or service this equipment. Failure to comply with this warning could result in equipment damage, personal injury, or death.

Refrigerant Charging

NOTE: The unit must be charged at a fixed speed setting. For this purpose the thermostat/controller needs to be wired and powered prior to charging. Using the thermostat, go to CHARGE MODE under SERVICE TESTS from the INSTALLER SETTINGS menu, described later in this document. Select CHARGE MODE to add or verify system charge. In the CHARGE MODE screen, HEATING or COOLING mode may be selected, depending upon which mode of operation is more appropriate or convenient at the time of charging.

NOTES:

- The heat pump is factory charged for field installed lines 15 ft. in length with the matching indoor equipment. Adjustments to the refrigerant charge will be required for other length and tube sizes. For lines longer than 15 ft with a 3/8" OD liquid line, add 0.52 oz. per ft.
- Small variations in the temperatures and pressures are normal due to differences in the installation.
- Large variations in the temperatures and pressures could indicate incorrect charge or another problem with a component in the system.

The preferred method of charging is by weighing in the additional refrigerant required. If a charging scale is not available, the next preferred charging method would be to use the sub-cooling method in cooling mode.

MODEL:	2 TON (-024K)	3 TON (-036K)	4 TON (-048K)
Factory Charge (for 15 ft. line set)	10.7 lbs (171 oz)	12.7 lbs (203 oz)	12.7 lbs (203 oz)
Additional Charge for 50 ft. line set	+ 1.1 lbs (18 oz)	+ 1.1 lbs (18 oz)	+ 1.1 lbs (18 oz)
Additional Charge for 100 ft. line set	+ 2.8 lbs (44 oz)	+ 2.8 lbs (44 oz)	+ 2.8 lbs (44 oz)

Table 4. Refrigerant Charge Quantities

Alternate Procedure for Charging Heat Pump in Cooling Mode (with outdoor temperatures above 60 °F) Based on Subcooling:

While charging based on weight is preferred, this method is acceptable. Use this method when the outdoor temperature is 60°F or higher to verify the correct charge in cooling mode. The indoor temperature should be between 70°F and 80°F.

1. Connect the gauge manifold to the liquid and vapor service valves (Figure 8).
2. Start the system in CHARGE MODE, COOLING. Allow the system to run 15 minutes to stabilize.
3. Record the liquid refrigerant pressure in psig at the service valve.
4. Record the liquid refrigerant temperature in °F at the service valve.
5. Using the temperature value recorded, determine the corresponding liquid refrigerant pressure from the upper curve (for cooling) in the charging chart (Figure 9).
6. If the pressure measured in step 3 is less than the required liquid refrigerant pressure determined in step 5, then refrigerant needs to be added.
7. If the pressure measured in step 3 is greater than the required liquid refrigerant pressure determined in step 5, then the system is over-charged.
8. Add or remove charge from the system depending on the measurements recorded. Allow the system to stabilize for 15 minutes before taking the next readings.

Alternate Procedure for Charging Heat Pump in Heating Mode (with outdoor temperatures below 60 °F) Based on Subcooling:

Use this method when the outdoor temperature is 60°F or lower to estimate the correct charge in heating mode. The indoor temperature should be between 65° F and 75° F.

The preferred method of charging is by weighing in the additional refrigerant required. If a charging scale is not available, the correct charge can be estimated by this method. Refrigerant can be stored in the receiver and accumulators and result in an over-charged system. If it is necessary to use this method, follow up service should be scheduled when the temperature is above 60°F, and then charge should be verified in cooling mode.

1. Connect the gauge manifold to the liquid service valve and suction service port located at the left side of the access panel above the liquid service valve. See Figure 8.

2. Start the system in CHARGE MODE, HEATING. Allow the system to run 15 minutes to stabilize.
3. Record the liquid refrigerant pressure in psig at the service valve.
4. Record the liquid refrigerant temperature in °F at the service valve.
5. Using the temperature value recorded, determine the corresponding liquid refrigerant pressure from the lower curve (for heating) in the charging chart (Figure 9).
6. If the pressure measured in step 3 is less than the required liquid refrigerant pressure determined in step 5, then refrigerant needs to be added.
7. If the pressure measured in step 3 is greater than the required liquid refrigerant pressure determined in step 5, then the system is over-charged.
8. Add or remove charge from the system depending on the measurements recorded. Allow the system to stabilize for 15 minutes before taking the next readings.

SYSTEM SETUP USING THE IQ CONTROLLER

IMPORTANT:

It essential that the wires meant to provide 24 volts to the outdoor unit are not mistakenly connected to the communication terminals. Check again before you apply power!

General

Power up the entire system with the iQ controller (thermostat) installed in its base. The controller will be of use to the installer for the following general purposes:

- Configuring the system using INSTALLER SETTINGS screens (required)
- Running system service tests (recommended)
- Using service information screens to examine and diagnose system operation (very helpful, if needed)
- Setting options and features which are not typically used or understood by the homeowner (recommended)
- Setting options and features with the homeowner's oversight in an effort to train him/her (suggested)

The following descriptions of the controller apply specifically to software Version 5.0. A summary of the controller menu structure is provided in Figures 10 & 11. **NOTE:** This guideline is not intended to be a comprehensive substitute for proper iQ Drive system training (required).

Screen Navigation

Moving between option categories on menu screens or moving between possible values for any one option is done using the ▲ and ▼ keys. The line or value with a dark background behind the characters is considered "selected". In order to change a selected option in most screens, or to save a changed value, use the ■ key. Use the ◀ key to back up into the previous screen in the menu/screen structure.

The Main Screen

The Main Screen is the normal display viewed on the controller. It prominently shows room temperature and

operating mode (e.g., COOL or HEAT) in large numerals and letters. Across the bottom line of the display are five words or abbreviations (normally RH TEMP MODE FAN MENU) which represent selectable entry points into the menus. The user can always return to the main screen from any other screen by repeatedly pressing the ◀ key.

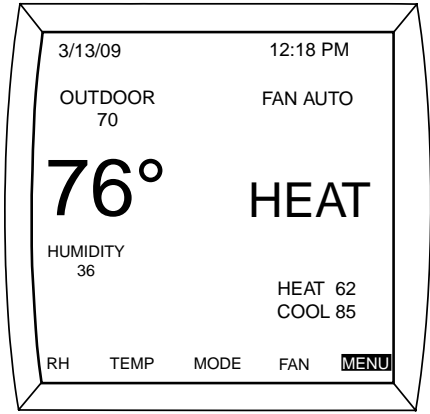

For iQ Zone systems with zone control enabled, the Main Screen will appear slightly different, as shown below. The local temperature reading is absent, and ZONE CNTL appears under the operating mode.

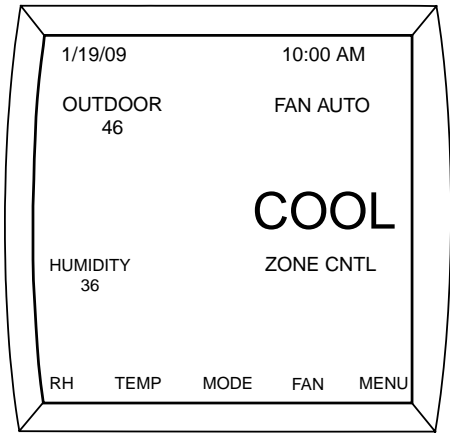

Installer Settings

Using procedures explained in iQ Drive training, go to the INSTALLER SETTINGS menu screen.

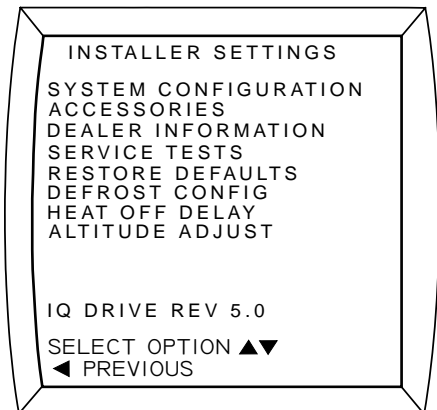

Other than in the splash screen displayed when power is first applied to the controller, this is the only screen which displays the controller software version number.

NOTE: It is important that any settings or service tests which are appropriate be made at the time of system installation.

System Configuration

Any time “CONFIGURATION NEEDED” appears at the top of the Main Screen, the user must proceed through the SYSTEM CONFIGURATION screens, even if no changes to values or options are necessary. This will occur when installing a new thermostat or moving a thermostat to a different type of iQ system. **The outdoor unit should be powered up when confirming or entering system configuration.**

With the first line SYSTEM CONFIGURATION selected, press the ■ key to proceed through the system configuration screens. The next screen, titled SYSTEM CONFIGURATION, provides a read-only summary of the configuration (as detected, and otherwise showing either defaults or previously configured information).

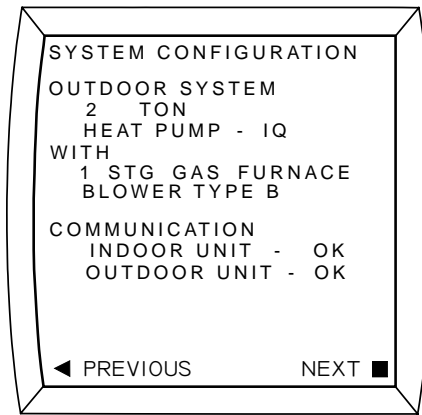

The words under OUTDOOR SYSTEM and WITH describe the system components as automatically detected by the controller. Both entries under COMMUNICATION should show “OK”. If “CHECK” appears, it is an indication that either communication wiring is incomplete or incorrect, or the outdoor unit is not powered up. Proceed through subsequent screens by using either the ▶ or ■ key (indicated by “NEXT”).

The following table indicates the information that may be or needs to be manually configured or confirmed by the installer. (Information not listed is automatically determined.) If necessary, check the ratings of the indoor unit before proceeding.

Indoor Unit	Items Requiring Manual Configuration (or Confirmation)
Electric Heat	Heat type, number of stages, staging differentials, kW
G6 gas furnace	Heat type, number of stages, 1 st stage start differential, furnace input rate, furnace rise. If 2-stage: 2 nd stage differential
G7 single stage gas furnace	1 st stage start differential, furnace rise
G7 two stage gas furnace	1 st stage start differential, 2 nd stage differential, furnace rise
Modulating MQ gas furnace	Furnace rise

Table 5. System Configuration Entry Summary

For MQ modulating iQ gas furnaces only, an additional screen titled "OUTDOOR SYSTEM" will appear after the SYSTEM CONFIGURATION summary screen. "HEAT PUMP-IQ" should appear on the second line; no other option may be selected in this screen. Press the ► key to proceed.

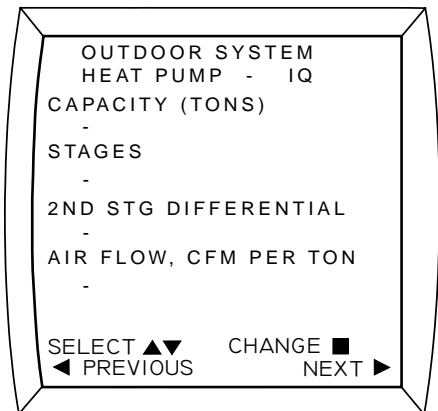

Proceed through the subsequent configuration screens either accepting or changing entries, until the INSTALLER SETTINGS menu is displayed again. This is an indication that configuration has been completed.

Accessories

Use the ▲ or ▼ keys to select ACCESSORIES. Press the ■ key to enter the accessories submenus and screens. This set of screens allows the installer to trigger alerts (reminders) when periodic maintenance is recommended for any of the following accessories:

- Air filter
- Humidifier
- U/V lamp
- Air cleaner

If desired, set the maintenance alert timing for any of these based on either hours of operation or calendar time. When triggered by the passing of the selected time or operating hours, the maintenance reminder message string will be displayed on the top of the Main Screen. In addition, at the base of the Main Screen "CANCEL ALERT" will appear. When this is selected and the ■ key is pressed, the maintenance reminder message will be removed.

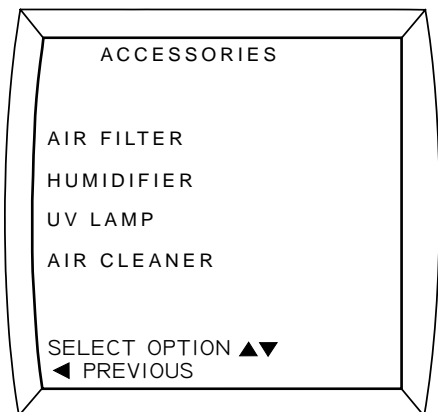

Making changes or entries under ACCESSORIES is optional.

Dealer Information

Use the ▲ or ▼ keys to select DEALER INFORMATION. Press the ■ key to enter the dealer information summary screen, and submenus and screens. This set of screens allows the installer to enter text information which will be displayed on a SERVICE NEEDED display screen if a persistent fault occurs. The following items may be entered:

- Brand name (Maytag, Frigidaire, NuTone, Broan, Tappan, Westinghouse, or custom)
- Model Number
- Contractor Name
- Contractor Phone Number

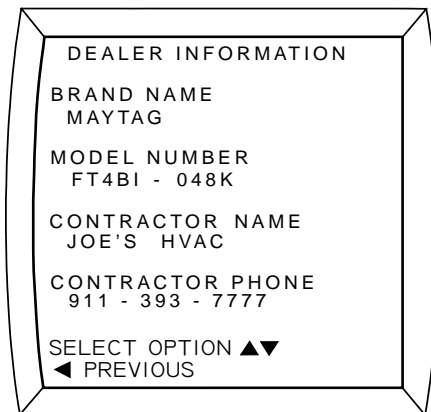

The entered dealer information summary screen accessible here will be available for future reference by a serviceperson (under INSTALLER SETTINGS > DEALER INFORMATION). Entry of this information is optional.

Defrost Configuration

Use the ▲ or ▼ keys to select DEFROST CONFIG. Press the ■ key to enter the screen which allows changes to:

- DEFROST TERMINATION TEMPERATURE. This is the outdoor coil temperature value which, when reached during the defrost sequence, will signal the end of the defrost phase during which the system heats up the outdoor coil to melt accumulated frost. (Default value is 75°F.)
- COIL DEFROST DELTA T. During heat pump heating operation a defrost sequence will be triggered when the outdoor coil temperature falls this amount below the temperature it would operate at with a clear, unfrosted coil. (Default value is 6°F.)

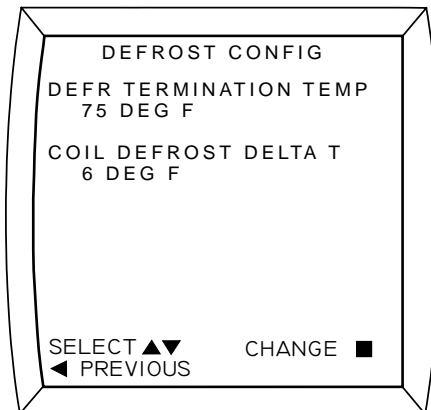

Under normal circumstances it is not necessary or advisable to change these from their default values.

Heat Off Delay

If the system includes a G6 gas furnace, you may use the ▲ or ▼ keys to select HEAT OFF DELAY. Press the ■ key to enter the screen which allows changes to the length of time that the blower (indoor fan) will remain on after the furnace flame is extinguished. Under normal circumstances it is not necessary or advisable to change this from its default value of 120 seconds.

Altitude Adjust

If the system includes an iQ modulating gas furnace, you may use the ▲ or ▼ keys to select ALTITUDE ADJUST. Press the ■ key to enter the screen which allows changes to the installation altitude (feet above sea level). This entry is advisable for the modulating gas furnace. Refer also to the furnace Installation Instructions.

Service Tests

You may use the ▲ or ▼ keys to select SERVICE TESTS. Press the ■ key to enter the screen which allows access to a list of service tests. These tests provide an easy way for the service person to operate the system in various modes for operational confirmation and diagnostic troubleshooting during installation startup. The following five options are available in the submenu.

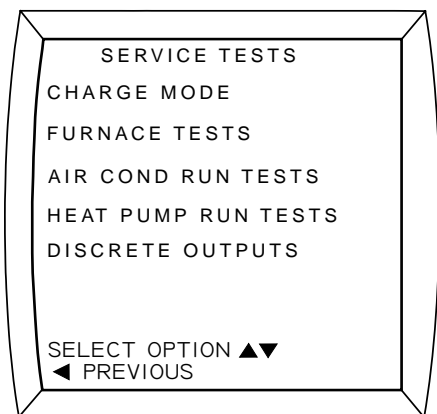

NOTE: While running the system from Service Tests is convenient for some startup operations, much of the normal fault handling and diagnostic message functionality is disabled.

Within each test screen there may be more than one entry which can be changed. Select the desired entry to be modified using the ▲ and ▼ keys. The line or value with a dark background behind the characters is considered “selected”. Press the ■ key to allow changing the selected item (its dark background will then blink). Set the desired value for the item using the ▲ and ▼ keys, then press the ■ key to save it.

The following is a brief description of the SERVICE TEST categories. **NOTE:** With iQ Zone systems there may be a delay before the test begins, as all zone dampers open.

CHARGE MODE – Runs the system at the proper speed for checking and adjusting refrigerant charge. Select the mode as HEATING or COOLING, then change RUN from OFF to ON. The screen backlight will blink red. The user may navigate to other screens (e.g., SERVICE INFORMATION) during the process until ON in the CHARGE MODE screen is changed back to OFF and saved. The red blinking backlight serves as a reminder that the unit is operating in an abnormal (service) mode. Select OFF (from the list that includes ON and OFF) and SAVE (■) when finished.

FURNACE TESTS – Runs the system at the selected fire level to allow confirmation of proper operation. The screen backlight will blink red. A short list of instructions (reminders) is provided. Select START to run a single stage furnace. Select LO FIRE or HI FIRE to run a two stage furnace. The user may navigate to other screens (e.g., SERVICE INFORMATION) during the process. The red blinking backlight serves as a reminder that the unit is operating in an abnormal (service) mode. Select DONE (from the list that includes LO FIRE, HI FIRE, START, STOP) and SAVE (■) when the test is complete, before leaving the screen for the last time.

AIR COND RUN TESTS and HEAT PUMP RUN TESTS – In these screens the unit can be made to run at a fixed speed regardless of room temperature. RUN can be changed between OFF, MAX (speed), INTERMED(iate speed), and MIN (speed). MAX speed is the same as that used in charge mode. The screen backlight will blink red when anything but OFF is selected and saved. The user may navigate to other screens (e.g., SERVICE INFORMATION) during the process until RUN in this screen is changed back to OFF and saved. The red blinking backlight serves as a reminder that the unit is operating in an abnormal (service) mode. This screen is primarily intended for test agency usage. Heat pump run tests apply only to heat pump units. Select OFF and SAVE (■) when finished.

For iQ heat pumps the capability to force a defrost is available. As indicated on the HEAT PUMP RUN TESTS screen, this feature may only be used when MAX speed has been selected. To perform a sample defrost while a MAX speed heating run test is running, press the ▼ key to select DEFROST NOW, then press the (■) key to begin the defrost. The defrost sequence will proceed, including use of auxiliary heat while heating the coil and the 8 minute post-defrost coil temperature calibration. Only use this feature if the outdoor conditions are typical heating conditions. Do not force a defrost before the system has operated in heating for several minutes first.

DISCRETE OUTPUTS – When the unit is off, this screen allows the user to operate certain relay-driven outputs in the system for diagnostic purposes: humidifier (on the indoor interface board or blower control board), reversing valve (on the outdoor interface board), indoor coil EXV (on the indoor interface board or blower control board), outdoor coil EXV (on the outdoor interface board), and crankcase heater (on the outdoor interface board). More than one of these can be set to ON at the same time. Leaving the DISCRETE OUTPUTS screen will shut all of the listed outputs off.

SERVICE INFORMATION SCREENS

Typically, when any of these service tests is being performed, the serviceperson should check operation visually, with special instrumentation (if available), and view operational data on the SERVICE INFORMATION screens. Refer to iQ Drive training information for how to view these screens.

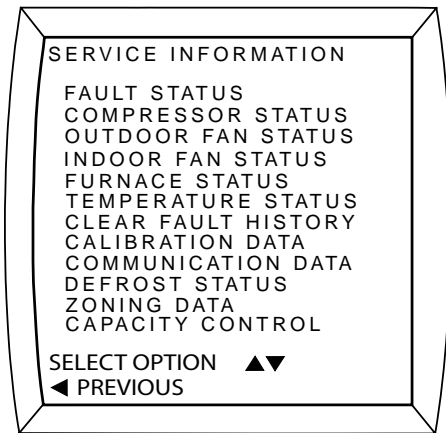

Most of the items on the SERVICE INFORMATION menu are self-explanatory by title. Some key features are the following (by item name):

FAULT STATUS – The top entry is ACTIVE FAULT. This should show NO FAULT unless the last fault detected has not cleared after its 5 minute lockout period, or the fault condition still exists. The remainder of the screen shows a history of previous faults or conditions detected, with military time and date stamps for each. (Having the correct time and date configured is important in making this list useful.) Use the ► key to view the remainder of the last (most recent) 10 faults logged. Generally, fault logging is not functional during Service Tests.

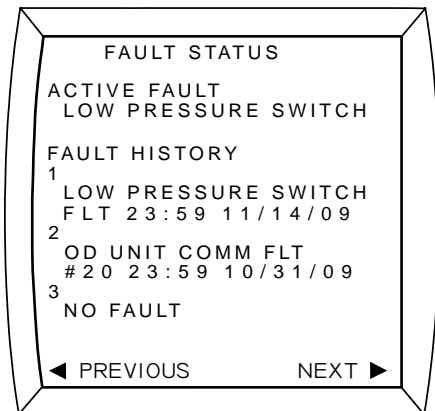

COMPRESSOR STATUS – This screen should confirm the configured size as MODEL NUMBER (20 = 2 tons, 30 = 3 tons, etc.) With correct configuration only 20, 30, or 40 should appear here. LOW PRESSURE SW shows the state of the low pressure switch. Any COMPR ERROR CODE number (normally 0) will be logged in the FAULT STATUS screen in more easily understood wording. The displayed information is read from the outdoor unit.

OUTDOOR FAN STATUS – Any FAN ERROR CODE number (normally 0) will be logged in the FAULT STATUS screen in more easily understood wording.

INDOOR FAN STATUS – The contents of this screen varies depending on which type of blower motor is in the equipment and whether or not iQ Zone is in use. Much of the information is not useful to the installer.

TEMPERATURE STATUS – This screen lists all temperatures measured by the iQ system. TEMP AT TSTAT is the local temperature used for control (when zoning is not enabled), and it displays one decimal place without showing the decimal point (e.g., 704 = 70.4°). In iQ Zone systems, a supply duct temperature sensor is required, and its reading is displayed here.

CLEAR FAULT HISTORY – It is recommended that any faults that appeared during and as a consequence of installation be cleared out before leaving.

CALIBRATION DATA – A Panasonic blower can be recalibrated any time from this screen by pressing the ► key. This may be done if a significant change has been made to blower discharge ducting or damper usage. This screen is not normally useful to an installer. Data is not displayed for type “B” blower motors.

COMMUNICATION DATA – This important screen indicates the status of communication with all elements on the iQ bus. All should show OK. If not, investigate and resolve communication wiring issues. In iQ Zone systems only, the entry ZONE BOARD will be displayed, representing the main Airzone control board.

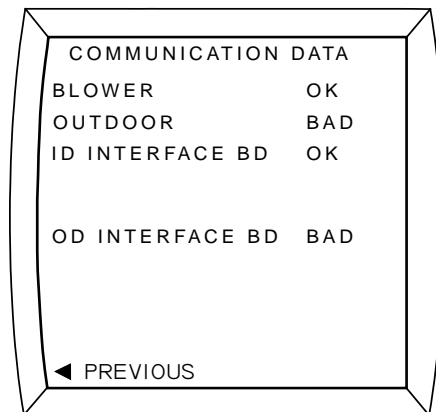

DEFROST STATUS – This screen confirms that a heat pump is in defrost and provides detailed information helpful to understand (a) the status of an in-progress defrost cycle and (b) conditions which may trigger the next defrost cycle. It also indicates the state of the reversing valve (ON for cooling or during defrost heating). (Refer to training.)

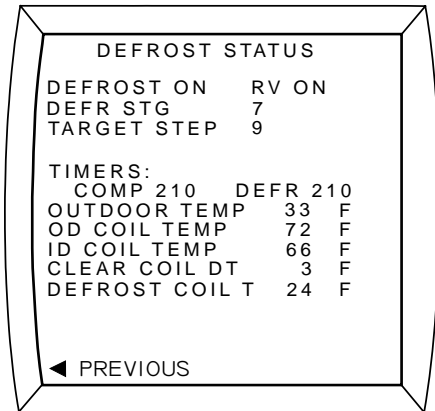

ZONING DATA – This screen and its sub-screen ZONE MODULE STATUS (accessible by pressing the ► key when in the ZONING DATA screen) provide important information to help confirm proper installation and setup of an iQ Zone system. Among other things, the ZONING DATA screen shows the numbers of the zones which are active (open and in use) and the weighting assigned to each zone.

Press the ► key to view ZONE MODULE STATUS. During zone system setup this screen will indicate which zone modules are detected in the zone system communication network, which zone each module is associated with, and any damper motor issues. After installation of an iQ Zone system, this screen is essential to confirm that all module assignments have been made and detected correctly.

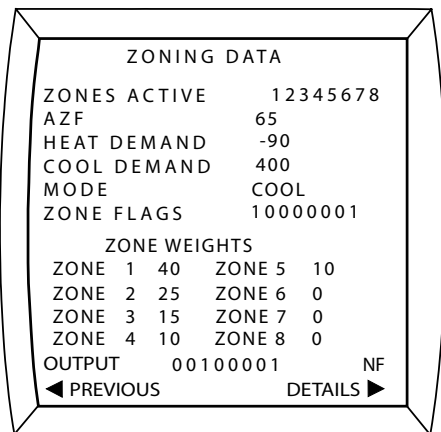

CAPACITY CONTROL – This screen contains information primarily relating to the status of the outdoor iQ unit. Target and actual speeds are shown for the compressor, outdoor fan, and indoor blower. The line above “ROOM TEMP” displays helpful system status messages, including whether or not the system is dehumidifying during cooling.

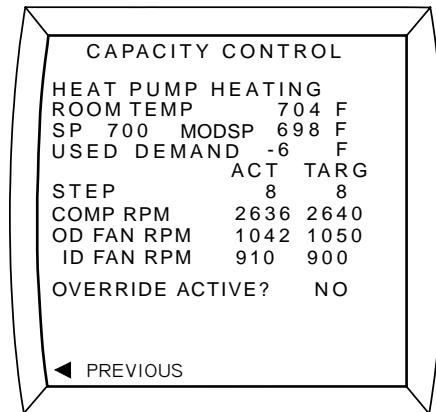

Other Configuration Entries

The following settings in the controller fall into the following categories:

- options and features which are not typically used or understood by the homeowner, and should be examined and considered for adjustment if desired by the installer, including:
 - minimum heat pump operating temperature
 - autochangeover time
- settings which are recommended to be done by the installer, including:
 - setting date and time
- options and features which are recommended to be set with the homeowner’s oversight, including
 - selection of programmable schedule versus non-programmable
 - usage of dehumidification (enabled by default)
 - humidity settings
 - usage of Smart Recovery (disabled by default)
- further features which the installer may demonstrate to the homeowner, including
 - schedule, including setback temperature settings
 - usage of holds
 - fan options
 - temperature units (°F or °C)
 - USA clock or military time (12 or 24 hour)
- settings and features which are unique to the iQ Zone system (if installed) which should be explained to the homeowner, including
 - how to disable or re-enable zone control
 - ventilation (fan) options
 - settings typically made at the iQ controller which do not apply with an iQ Zone system (with zone control enabled)
 - settings associated with an iQ Zone system (with zone control enabled) which are entered at local zone thermostats, not from the iQ controller

The above settings are described below:

Minimum Heat Pump Operating Temperature

This is the outdoor temperature (measured beneath the outdoor unit control panel) below which, when heating is called for, the heat pump will not operate and backup heat means (electric heat or gas furnace) will take over. The ideal temperature setting is the “balance point” below which it would be more

economical to run the backup heat rather than the heat pump. The default and minimum value for this parameter is 12°F. Once the outdoor temperature rises above this setpoint, the heat pump will be permitted to operate again after the demand has been satisfied and backup heat has shut off. (Determination of the balance point is not simple and depends on a variety of local factors, including the price of electricity and gas at any particular time.) To modify the value, perform the following:

1. From the Main Screen, press the ◀ or ▶ key to select MENU at the bottom of the screen, then press the ■ key to see the Main Menu.
2. Use the ▲ or ▼ key to select SETTINGS, then press the ■ key to enter the Settings menu.
3. Use the ▲ or ▼ key to select OPTIONS, then press the ■ key to enter the Options screen.

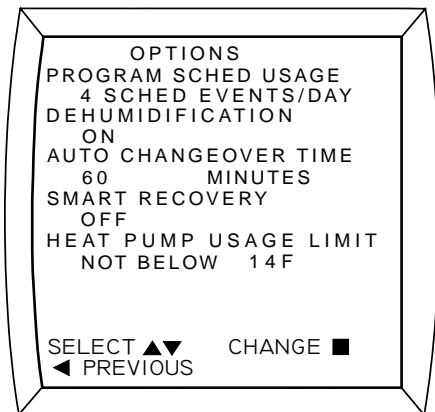

4. Use the ▲ or ▼ key to select the value under HEAT PUMP USAGE LIMIT, then press the ■ key to allow changing the setting.
5. Use the ▲ or ▼ key to change the value (2°F increments), then press the ■ key to save the setting.
6. Press the ◀ key multiple times to return to the Main Screen.

Auto Changeover Time

This adjustment enables AUTO mode, which allows the system to automatically switch between heating and cooling without having to touch the controller. Autochangeover time is the delay (minimum time) between the end of cooling operation and the beginning of heating operation (or the reverse). DISABLE removes AUTO as an available mode. Otherwise, the time may be selected from 15 to 120 minutes (default 60 minutes). To modify the value, perform the following:

1. From the Main Screen, press the ◀ or ▶ key to select MENU at the bottom of the screen, then press the ■ key to see the Main Menu.
2. Use the ▲ or ▼ key to select SETTINGS, then press the ■ key to enter the Settings menu.
3. Use the ▲ or ▼ key to select OPTIONS, then press the ■ key to enter the Options screen.
4. Use the ▲ or ▼ key to select the value under AUTO CHANGEOVER TIME, then press the ■ key to allow changing the setting.
5. Use the ▲ or ▼ key to change the value, then press the ■ key to save the setting.
6. Press the ◀ key multiple times to return to the Main Screen.

Date and Time

Setting date and time early in the installation process not only saves the homeowner from having to do it, but provides an accurate time and date stamp for any faults logged (during installation checkout, for example) in FAULT HISTORY. By default, the clock is in 12 hour format. This may be changed on the OPTIONS menu screen (see either of the above two items). Daylight Saving Time is automatically taken into account but may be disabled from the SET DATE AND TIME menu screen. To set date and time, perform the following:

1. From the Main Screen, press the ◀ or ▶ key to select MENU at the bottom of the screen, then press the ■ key to see the Main Menu.
2. SET DATE AND TIME will be selected. Press the ■ key two times.
3. Enter the year, month, day (date), hour, and minute on consecutive screens. Use the ▲ or ▼ key to change any value, and press the ▶ key to advance to the next. After setting the minutes value, press the ■ key to save the complete setting.
4. Press the ◀ key multiple times to return to the Main Screen.

Program Schedule versus Nonprogrammable.

While using “setback” program schedules are advisable to take advantage of potential economic and energy savings, some homeowners still prefer to perform setpoint adjustment by exclusively using the ▲ and ▼ keys. The following setting provides the nonprogrammable option or the option for different numbers of events per day (2 or 4) on the program schedule. To set the program schedule option, perform the following:

1. From the Main Screen, press the ◀ or ▶ key to select MENU at the bottom of the screen, then press the ■ key to see the Main Menu.
2. Use the ▲ or ▼ key to select SETTINGS, then press the ■ key to enter the Settings menu.
3. Use the ▲ or ▼ key to select OPTIONS, then press the ■ key to enter the Options screen.
4. The value under PROGRAM SCHED USAGE will be selected. Press the ■ key to allow changing the setting.
5. Use the ▲ or ▼ key to change the value between “NON PROGRAMMABLE”, “4 SCHED EVENTS/DAY”, “2 SCHED EVENTS/DAY”, and “2 EVENTS/D BUSINESS”. Then press the ■ key to save the setting. (The difference between “2 EVENTS/D BUSINESS” and “2 SCHED EVENTS/DAY” is only the name given to the time blocks within a daily schedule.)
6. Press the ◀ key multiple times to return to the Main Screen.

Dehumidification

When dehumidification is enabled (as it is by default), the system will (depending upon the conditions) suspend responding to room temperature and lower blower speed to enhance removal of moisture from the air circulating through the indoor coil. When operating in this manner, the unit will run cycles of 10 minutes dehumidifying, 5 minutes normal cooling (adjusting capacity). See also setting the humidity setpoints in (6) below. To change the dehumidification option, perform the following:

1. From the Main Screen, press the ◀ or ▶ key to select MENU at the bottom of the screen, then press the ■ key to see the Main Menu.
2. Use the ▲ or ▼ key to select SETTINGS, then press the ■ key to enter the Settings menu.
3. Use the ▲ or ▼ key to select OPTIONS, then press the ■ key to enter the Options screen.
4. Use the ▲ or ▼ key to select the value under DEHUMIDIFICATION, then press the ■ key to allow changing the setting.
5. Use the ▲ or ▼ key to change the value between “ON” (the default) and “OFF”, then press the ■ key to save the setting.
6. Press the ◀ key multiple times to return to the Main Screen.

Humidity Settings

Separate setpoints for humidification and dehumidification are available in units of percent RH (relative humidity). The humidify setpoint only is relevant if optional humidifier equipment has been installed and connected to the system (the 24 vac “H” output – See the Field Wiring Installation Instructions). The installer should clarify for the homeowner that priority is given to cooling over dehumidifying, so the ability of the system to satisfy the RH setpoint(s) depends on a variety of conditions. For example if the cooling load causes the unit to run at an intermediate speed or higher, the effectiveness of dehumidification is increased.

Humidification can operate when the system is heating or the fan is set to Manual (ON) with the compressor off. Dehumidification can operate only when the system is cooling mode, the dehumidification option is enabled, and room temperature is close to the setpoint. To set the humidity setpoint(s), perform the following:

1. From the Main Screen, press the ◀ or ▶ key to select RH at the bottom of the screen, then press the ■ key to see the Humidity screen. The current setpoints are displayed.
2. As indicated at the bottom of the screen, press the ▶ key to enter the Humidity Settings screen.

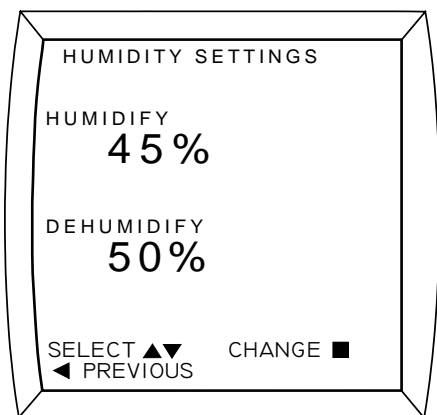

3. Use the ▲ or ▼ key to select the RH setting to change, then press the ■ key to allow changes.
4. Use the ▲ or ▼ key to change the RH setting then press the ■ key to save the setting. The configurable ranges for

- HUMIDIFY and DEHUMIDIFY are different, and changing one may push the other so that a minimum of 5% is maintained between the settings. The humidify setpoint can be set in the range 30 to 45% in increments of 5%. The dehumidify setpoint can be set in the range 35 to 70% in increments of 5%. Press the ■ key to save any changes
5. Press the ◀ key multiple times to return to the Main Screen.

Smart Recovery

When Smart Recovery is enabled, the system will start changing the cooling or heating setpoint in advance of a schedule change so that the room temperature is at or near the setpoint of the subsequent schedule time block when that time block begins. It only applies if the subsequent cooling setpoint is lower or heating setpoint is higher. Also, if PROGRAM SCHED USAGE is set to NON PROGRAMMABLE, this option does not apply. To change the smart recovery option, perform the following:

1. From the Main Screen, press the ◀ or ▶ key to select MENU at the bottom of the screen, then press the ■ key to see the Main Menu.
2. Use the ▲ or ▼ key to select SETTINGS, then press the ■ key to enter the Settings menu.
3. Use the ▲ or ▼ key to select OPTIONS, then press the ■ key to enter the Options screen.
4. Use the ▲ or ▼ key to select the value under SMART RECOVERY, then press the ■ key to allow changing the setting.
5. Use the ▲ or ▼ key to change the value between “OFF” (the default) and “ON”, then press the ■ key to save the setting.
6. Press the ◀ key multiple times to return to the Main Screen.

Zone Control

The installer should provide to the homeowner(s) a document or diagram which lists or shows (a) the rooms assigned to each zone number, (b) the weighting assigned to each zone, (c) the zone module number associated with each supply vent.

Current date and time must be set in the iQ thermostat/controller since they will be transmitted to, and continually updated in the local zone thermostats. The Security Lockout feature will not prevent changing settings in local zone thermostats in an iQ Zone system.

Temperature units (Fahrenheit or Celsius) can be changed as follows: Locate the set of eight microswitches on the iQ Zone main circuit board. Disconnect control power from the circuit board. Set microswitch #6 up (on) for °F, down (off) for °C. Reconnect control power.

It is recommended for the installer to instruct the homeowner(s) on the following:

For zoning operation, Operating Mode (COOL, HEAT, AUTO, E-HEAT, or OFF) must be selected from the iQ Drive thermostat/controller as with non-zoning systems. However, the temperature setpoints that will be used are entered and stored at the local zone thermostats. With iQ Zone systems,

all settings made in the iQ thermostat/controller dealing with temperature setpoint (temporary hold, vacation hold, permanent hold, time schedule, smart recovery) do not apply unless zone control is disabled. Similar features are provided and controlled at each zone independently, from the local zone thermostats. For example, Manual Setpoint Control replaces Temporary Hold, Automatic Setpoint Control replaces time schedules, and Sleep Mode replaces Smart Recovery. See the iQ Zone System Zone Thermostat User's Manual for information on these alternative features.

NOTE: iQ Zone systems with Version 1.0.0 zone thermostats use a single setpoint for both heating and cooling. iQ Zone systems with Version 2.0.x thermostats (with the backlight feature) use separate setpoints for heating and cooling (as with the standard non-zoning control), with the cooling setpoint always being at least 2°F higher."

Zone Control is enabled by default if the system is equipped with and wired for iQ Zone (the normal operating situation). However, zone control operation can be disabled by choice, or it may be automatically disabled if there is a problem detected with it. To manually disable zone control when zoning is already enabled:

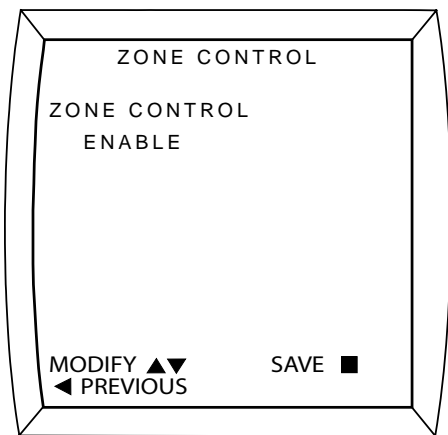

1. From the Main Screen select MENU using the ◀ or ▶ button.
2. Press the ■ button.
3. Select SETTINGS using the ▲ or ▼ button.
4. Press the ■ button.
5. Select ZONE CONTROL using the ▲ or ▼ button.
6. Press the ■ button.
7. Press the ▲ or ▼ button to change ENABLE to DISABLE.
8. Press the ■ button to save the setting.

To restore zone control (when the zoning system components are functioning properly), follow the above sequence, but in step 7 change DISABLE to ENABLE.

iQ Zone offers two types of ventilation that can be turned on when the cooling or heating systems are not running:

- To deliver air to some but not all zones when not heating or cooling, use the zone ventilation feature that is set up at the individual zone thermostats. See the iQ Zone System Zone Thermostat User's Manual for information on how to set up zone-by-zone ventilation. From the FAN MENU, enter the VENTILATION SPEED screen in the iQ thermostat/

controller to select or modify the relative speed to be used when this type of ventilation is operating.

- To use the fan to deliver air to all zones when not heating or cooling, set the Fan Mode to ON. The Intermittent Fan feature described earlier will also operate, serving all zones.

Refer to the iQ Drive User's Manual for other details relating to zone control operation.

System Operation: Quick Start

The following is a summary of the sequence for typical operation of the system.

1. Set the date and time (if not already set).
2. Check the program schedule for desired "setback", and modify if desired.
3. From the main screen, check/set the Fan operating mode:
 - AUTO operates the fan (indoor blower) when the unit is cooling or heating. This is the "normal" setting.
 - ON operates the fan at the selected speed at all times. The selected speed may change when the compressor, electric heat, or furnace is operating.
 - PROGRAMMED FAN operates the fan in AUTO or ON as specified in the program schedule.

4. From the main screen, check/set the Mode:

- COOL runs the heat pump as an air conditioner using the cooling setpoint. (With iQ Zone, zone control enabled, there is a single setpoint for both heating and cooling.)
- HEAT attempts to run the heat pump to provide heat using the heating setpoint. If (a) the outdoor temperature is below the Heat Pump Usage Limit, or (b) the heat pump cannot satisfy the load, or (c) the heat pump is disabled due to a fault, auxiliary (backup) heat will operate. If backup heat is electric strip heat, it may operate along with and supplementing the heat pump. If backup heat is a gas furnace, the furnace and heat pump will not operate at the same time (except during defrost). (With iQ Zone, zone control enabled, there is a single setpoint for both heating and cooling.)

If the outdoor coil temperature is below 35°F, demand defrost is enabled. Under these conditions, a first time defrost will occur after approximately one half hour of compressor operation. Subsequent defrost cycles may be triggered by a drop in outdoor coil temperature or by a maximum time between defrosts of 6 hours. Refer to training material for details.

- E HEAT will run the auxiliary heat (electric strip heat or gas furnace) using the heating setpoint and disable the heat pump.
- OFF terminates any of the above.

NOTE: Equipment may not shut off immediately after switching to OFF due to various system limitations. Once put into the OFF mode, wait until the furnace or compressor has shut off before selecting another mode.

5. For systems without iQ Zone, adjust the operating setpoint if desired using a temporary hold (pressing the ▲ or ▼ key when the Main Screen is displayed). With iQ Zone, zone control enabled, adjust the operating setpoint for each zone individually by touching the ▲ or ▼ icon. (Refer to iQ Zone System Zone Thermostat User's Manual for details.)

System Startup Checkout & Troubleshooting

The following is a summary of the sequence for typical first operation to check out the system. Reference is made to INSTALLER SETTINGS and SERVICE INFORMATION described above.

1. Install system hardware as described in the individual component installation instructions.
2. Install power and control wiring to all system components, including the controller, in accordance with the iQ Field Wiring Installation Instructions.
3. Perform pre-charge evacuation of field-installed refrigerant lines as described in preceding sections.
4. For iQ Zone systems, first apply 12 volt dc power to the zone control board with the provided AC/DC converter. Apply electrical power to the system (including the heat pump). The controller screen display backlight should come on, and the "iQ" splash screen should appear. If it does not, trace the 24 vac control power to the "R" terminal on the thermostat. CONFIGURATION NEEDED should appear on the top line of the Main Screen (unless the thermostat had been previously used on a similar iQ system).
5. Proceed with System Configuration from the INSTALLER SETTINGS menu (described above). On the SYSTEM CONFIGURATION screen verify that the using size (2 ton, 3 ton, or 4 ton) is correct as indicated. If the wrong value is shown, the inverter may require re-initialization. Contact the service representative of the distributor in this case.

On the same screen, the entries under COMMUNICATION should be followed by "OK". If "CHECK" appears for a communication item, go to the COMMUNICATION STATUS screen (in the SERVICE INFORMATION menu, described above), and view which elements are not communicating. Trace and check the three communication wires throughout the system. If isolating a communication problem proves to be difficult, it may be useful to disconnect all communication wires except those which link the thermostat and the non-communicating element.

6. If COMMUNICATION STATUS was not checked during the previous step, check it at this time. All listed items should show a status of "OK". If any show "BAD", determine the source of the problem as indicated in the previous step, and resolve.
7. For iQ Zone systems only, the main screen should appear with no temperature reading, and "ZONE CTRL" should appear below "OFF". If this is not the case, go to the ZONE CONTROL screen from the SETTINGS menu, and change the zone control option to ENABLE. If ZONE CONTROL does not show up on that menu, the iQ controller has never communicated with the zone control board, and power and

communication wiring to the zone control board need to be checked. If the main screen reverts to back to the zoning-disabled screen (showing room temperature), power and communication wiring to the zone control board need to be checked.

8. Set date and time as described above. This will provide a "time stamp" for any fault which may arise during system checkout.
9. If the installation includes a new gas furnace, check out its operation first. This may be best accomplished from FURNACE TESTS under SERVICE TESTS from the INSTALLER SETTINGS menu (see above). Follow steps instructions provided in the furnace's installation instructions. Be sure to verify blower operation during the test.
10. If the outdoor temperature is above 60°F (14°C), test the refrigerant system running in cooling mode first. If the outdoor temperature is between 12° and 60°F (-11 and 14°C), test the refrigerant system running in heating mode first. This may best be accomplished from CHARGE MODE under SERVICE TESTS from the INSTALLER SETTINGS menu. Follow the refrigerant charge adjustment procedure explained above. Note that if a fault is determined in the outdoor equipment, the backup heating means (electric strip heat or gas furnace) will start instead.
11. When charge adjustment is completed (if required), run the heat pump in both cooling and heating modes. This may also be done using SERVICE TESTS although some diagnostic messages are disabled in that method.
12. Check the FAULT STATUS screen (described above) for any faults logged during the startup process. Any message listed as "ACTIVE FAULT" refers to a condition which either still exists or occurred within the preceding 5 minutes. Every fault or notification should appear in the FAULT HISTORY log which starts on the same screen. The last 10 faults to have occurred are retained in this list. Each new item pushes other logged faults down in the list. The second line associated with each of the 10 entries includes the time and date of detection. While the wording of fault messages is intended to provide a reasonable indication as to the responsible condition, the information conveyed by the abbreviated wording is limited. Consequently the installer should refer to training literature for further information in understanding fault messages.
13. If needed, make use of information provided below under Troubleshooting: What to Expect with Normal Operation.
14. Independently confirm operation of any accessories installed with the heat pump system following instructions provided with that equipment.
15. Complete the remainder of configuration settings and entries as specified above under Installer Settings and Other Configuration Entries.
16. For iQ Zone systems, confirm the zone system setup by checking information on the ZONING DATA and ZONE MODULE STATUS screens, accessed from the SERVICE INFORMATION menu. (See SYSTEM DIAGNOSIS AND TROUBLESHOOTING below.)

SYSTEM DIAGNOSIS & TROUBLESHOOTING

The following is a summary of normal and abnormal operation for typical startup to check out the system. Reference is made to INSTALLER SETTINGS and SERVICE INFORMATION screens described above. Refer to training literature for more details.

Diagnostic information for the heat pump can be obtained from all of the following sources:

- Controller displays. Refer to training materials for interpretation of fault messages which appear on the Main, Fault Status, and Service Needed screens.
- Refrigerant system pressure and temperature measurements (using standard field service instrumentation)
- LED indicator lights on each of the system's circuit boards (see below).

Controller

Normal - As soon as 24 vac power is applied, the blue backlight of the controller should light up. The "iQ" splash screen will display the software version. If the System Configuration procedure has not been performed yet for this system-controller combination, "CONFIGURATION NEEDED" will be displayed across the top (alternating with other information).

If the system has a Type "P" blower motor (shown on SYSTEM CONFIGURATION and INDOOR FAN STATUS screens), used in air handlers or G6 gas furnaces, the blower will self-calibrate for 60 seconds as soon as System Configuration is completed.

All communications links in COMMUNICATION DATA should show "OK". All information displayed in the System Configuration screen should be accurate.

Abnormal – If the display is not lit, check that 24 vac is being provided between the "R" and "C" terminals in the thermostat's back connection plate. If not, trace the connection of all controller wires back to the indoor unit (furnace or air handler). Check that connections are in accordance with field wiring diagrams and instructions.

If a SERVICE NEEDED screen with a red backlight is displayed, a fault has been detected. A brief description of the fault is displayed on the screen. Access to the FAULT STATUS screen is permitted.

If communication with the outdoor unit is OK but the unit size (in tons) shown on the System Configuration screen is wrong, contact the service representative of the equipment distributor. The inverter may not have undergone its initialization procedure, performed at the factory.

Outdoor Unit Inverter

WARNING

ELECTRIC SHOCK HAZARD!

Disconnect power before servicing the outdoor unit. Failure to follow these instructions may result in electric shock or death. Trouble-shooting the outdoor unit may require that power be restored with the control panel cover removed. Become familiar with the control panel and hazardous voltage areas before proceeding.

Time is required for inverter voltage to bleed down after removal of line power. Wait at least 60 seconds after removing line voltage before touching any inverter parts or wiring.

Normal – Examine the following with the control panel cover off. Note the two smaller circuit boards mounted on a metal "bridge" over the inverter. The red LED behind the upper right side of the bridge should be lit and on steady when power is applied to the inverter. Refer to Figures 3 and 12.

Abnormal – The red LED behind the upper right side of the bridge is not lit. In this case, power is not being provided to the inverter. Check that line voltage is being applied to the bottom of the contactor. If so, check that 24 vac is being provided across the contactor coil. If not, check the control power wiring (RED and GRY wires) for 24 vac. Check that the high pressure switch is closed. A fault indicating OD UNIT COMM FAULT or OD UNIT LOST POWER would also result from no line voltage applied.

The red LED behind the upper right side of the bridge is lit but blinking. This indicates that the inverter is powered up and that it detects a fault condition. If the controller does not display a fault message, put the unit into HEAT or COOL mode, and a message will be displayed. **NOTE:** When line power is removed, the red LED will blink for about 1 minute before going out. Check that the 3- and 4-position communication plugs are connected to the terminals marked "INVERTER" and "INDOOR" on the right side of the outdoor interface board.

Outdoor Unit Interface Board (right side small circuit board)

Normal – Refer to Figure 13. The red LED at the upper left of this board should do a "heartbeat" blink, consisting of a double-blink followed by a pause, repeated. Note 4 other LEDs towards the lower edge of the board. When the compressor is off, the 3rd LED from the right should be on (crankcase heater). When the compressor is running in heating, the 2nd LED from the right should be on (EXV enabled to open). When the unit is heating and in a defrost cycle, the 1st and 4th LEDs from the right should be on.

When the compressor is running in cooling, the right-most LED should be on (reversing valve is energized).

Abnormal – If no LEDs are lit on the board, 24 vac control power is not being provided across the “R” and “C” terminals. Check for this voltage between the left-most two screw terminals (labeled R and C).

Outdoor Unit EXV Board (left side small circuit board)

Normal – Refer to Figure 14. The green LED at the upper left of this board should be steadily on, except that a blink at a regular rate can be expected during cooling operation.

Abnormal – If the green LED is not lit, the EXV board is not getting 24 vac power from the interface board next to it. Check for 24 vac between R and C on the interface board, and check that the tabs marked “R” and “C” on the interface board are wired to “R” and “C” on the EXV board (red and gray wires, respectively). These should not be cross-wired.

If the green LED is blinking at a regular rate during heat pump heating, it indicates that one of the two EXV sensors is reading out of range. Refer to training literature for sensor interpretation and troubleshooting.

If the green LED is blinking at a non-uniform rate (heartbeat), it indicates that the board has been placed in the Manual Mode. Hold down the small black button on the board for more than 3 seconds to return it to automatic control mode.

Indoor Unit Interface Board (in G6 iQ furnace kit or air handler)

Normal – The red LED at the upper left of this board should do a “heartbeat” blink, consisting of a double-blink followed by a pause, repeated. Note 4 other LEDs towards the lower edge of the board. When the equipment is off, none of the LEDs should be on. If the furnace or electric strip heat is on, 3rd LED or 3rd and 4th LEDs from the right should be on (first and second stage auxiliary heat). When the unit is cooling the right-most LED should be on (EXV enabled to open). If humidification is called for, the 2nd LED from the right should be on.

Abnormal – If no LEDs are lit on the board, 24 vac control power is not being provided across the “R” and “C” terminals. Check for this voltage between the left-most two screw terminals (labeled R and C).

Indoor Unit EXV Board

Normal – The green LED at the upper left of this board should be steadily on, except that a blink at a regular rate can be expected during heat pump heating operation.

Abnormal – If the green LED is not lit, the EXV board is not getting 24 vac power from the interface board. Check for 24 vac between R and C on the interface board, and check that the tabs marked “R” and “C” on the interface board are

wired to “R” and “C” on the EXV board. These should not be cross-wired.

If the green LED is blinking at a regular rate during cooling, it indicates that one of the two EXV sensors is reading out of range. Refer to training literature for sensor interpretation and troubleshooting.

If the green LED is blinking at a non-uniform rate (heartbeat), it indicates that the board has been placed in the Manual Mode. Hold down the small black button on the board for more than 3 seconds to return it to automatic control mode.

Indoor Unit Constant CFM Motor Control Board

Normal – The red LED near the top of the board should be on steadily. The green LED near the top of the board should have a “heartbeat” blink, consisting of a double-blink followed by a pause, repeated. Of the four LEDs towards the left side of the board, the lowest one marked “H” should be on when humidification is called for.

Abnormal – If the green LED near the top of the board is not lit, the board is not connected to the communication network properly. If the red LED near the top of the board is not lit, the board is not getting 24 vac control power from the furnace board.

Indoor Unit One- or Two-Stage G7 Furnace Board

Normal – The red and green LEDs should be on steadily. When the furnace is on and a flame is detected, the amber LED should be on.

Abnormal – The LEDs will provide a diagnostic code through their blink pattern. Refer to furnace Installation Instructions for detailed troubleshooting.

Indoor Unit iQ Modulating Gas Furnace Board

Normal – The red LED should be on steadily. The green LED near the top of the board should have a “heartbeat” blink, consisting of a double-blink followed by a pause, repeated. When the furnace is on and a flame is detected, the amber LED should be on.

Abnormal – The LEDs will provide a diagnostic code through their blink pattern. Refer to furnace Installation Instructions for detailed troubleshooting. If the green LED alone is not lit, the board is not connected to the communication network properly.

Airzone Control Board

Normal – One red power LED should be on steady near where the dc power plugs into the board (upper left corner). Red and green LEDs at the lower right side of the board (just below the DIP switch block) flash quickly and continuously (indicating zone network activity). A second set of red and green LEDs (about 1” to the left of the other green and red LED pair) also flash, with the red LED flashing every 3 to 5 seconds, indicating iQ bus communication. See Figure 15.

Abnormal – If the red LED near the dc power plug is not on, then the AC/DC power supply is not connected or not working. If the red LED 1 ½” from the lower right edge does not flash, the module is not communicating properly on the iQ bus.

iQ Zone System Configuration

Normal – Check the ZONING DATA screen from the SERVICE INFORMATION menu (shown on page 11). In the lower portion of the screen the zone weights shown should match the intended values, and they should add up to 100(%).

ZONE MODULE STATUS		
MOD	MOD	MOD
1Z10	11Z10	21Z50
2Z20	12Z10	22Z
3Z3X	13Z20	23Z
4Z40	14Z23	24Z
5Z50	15Z20	25Z
6Z	16Z20	26Z
7Z	17Z3X	27Z
8Z	18Z3X	28Z
9Z10	19Z42	29Z
10Z12	20Z40	30Z
		31Z20
		32Z

◀ PREVIOUS

Press the ► key to view the ZONE MODULE STATUS screen (shown here). Every module installed in the system should show up on this list with the proper zone identification number after the “Z”, followed by a “0”. For example, “23Z40” is module 23 in zone 4. The “0” indicates normal functioning. Zone numbers should only appear with module numbers that were intended to be assigned. For master zone modules 1-8, the zone number must match the module number.

Abnormal – If any zone weight shown in the ZONING DATA screen is incorrect, or if the total for the eight zones is not 100(%), make the appropriate corrections from the zone thermostat for the zone(s) which require(s) correction.

If an installed zone module does not show up in the ZONE MODULE STATUS screen with an assigned zone number, such as with module 25 in the figure, check the wiring to that zone module. If the zone number is wrong or if the wrong module number shows up as used, the module needs to be reconfigured. If the last character after the zone number is not “0”, look for the following problems:

- “1” may indicate a disconnected damper motor connector.
- “2” may indicate a damper that is jammed due to blockage from a foreign object or damage or dirt on the internal transmission.
- “3” may indicate that a zone thermostat is not connected properly to its associated master zone module (1-8).
- “X” may indicate that a module is assigned but not communicating.

Common Troubleshooting Issues

Compressor Does Not Start Immediately

- For normal operation without changing modes of operation, the compressor will not restart until 5 minutes (the minimum off time) have expired since it shut off last.
- A minimum demand of 0.5°F is required before the heat pump (heating or cooling) will start up.
- The system will wait 5 minutes following detection of a fault condition before attempting a restart.

Compressor Does Not Shut Off Immediately

- For normal operation without changing modes of operation, the compressor will not shut off until 5 minutes (the minimum run time) have expired since it started last.

The Outdoor Fan Does Not Shut Off When the Compressor Does

- For normal operation the outdoor fan is designed to run for 30 seconds after the compressor shuts off.

In Cooling, the Blower Slows Down and the Unit Is Not Responding to Room Temperature

- Slowing of blower speed and suspension of normal capacity control will occur when the unit goes into Dehumidification. If conditions for dehumidification persist, the unit will run cycles of 10 minutes in dehumidification, 5 minutes in normal cooling (responding to room temperature).

In Heating, the Unit Appears to be Cooling

- During heat pump heating when the outdoor temperature is in the mid-30’s (°F) or lower, the unit will periodically go into a Demand Defrost operation. After power to the controller is turned on, the first defrost may occur as soon as 34 minutes after startup. Subsequently, defrost will be determined by outdoor coil temperature or by the maximum time between defrosts of 6 hours (if the coil temperature is low enough).

In Heat Pump Heating, the Furnace Runs At the Same Time

- The indoor (backup) heating system will operate during defrost cycles. (See above item.)

In Heating, the Furnace or Electric Heat Runs Instead of the Heat Pump

- The indoor backup heat equipment will run instead of the heat pump if (a) the outdoor air temperature is below the Minimum Heat Pump Usage Limit, (b) the heat pump is in a fault condition, or (c) the heat pump is not able to satisfy the demand (after a time delay).

The System Is In AUTO Mode, but It Won’t Switch Quickly From Heating to Cooling (or the Reverse)

- There is a configurable delay (Auto Changeover Time) between operating in heating and restarting in cooling (or the reverse) when in AUTO mode. The default delay for this changeover is 60 minutes.

Although There Is a Large Demand At Startup, the Compressor Only Runs at Medium Speed

- Regardless of demand the system will always start and run at an intermediate speed for one minute. Subsequently the speed may increase significantly.

Humidification or Dehumidification Setpoints Are Not Being Satisfied

- The first priority of the system is to achieve the temperature setpoint(s). While under most circumstances it will also satisfy humidity setpoints, its ability to accomplish this is significantly affected by a variety of installation-based factors and circumstances.

In an iQ Zone System, the system does not respond promptly to changes in setpoint or mode

- With zoning systems additional delays may be noticed. Most commonly this is due to no new changes processed until zone dampers have completed any prior operation. For example, an extra minute delay is deliberately included when one or more zones are closed.

MAINTENANCE

IMPORTANT:

Be certain the electrical power to the outdoor unit and the furnace or air handler is disconnected before doing the following recommended maintenance.

- Inspect the indoor air filter monthly. Clean or replace it at the start of each heating and cooling season or when an accumulation of dust or dirt is visible. If the indoor coil needs to be cleaned, contact a qualified service technician.
- Inspect the condensate disposal line from the indoor coil at the beginning of the cooling season to make sure it is not obstructed.
- Remove any leaves, grass clippings, and debris from the outdoor unit coil, being careful not to damage the aluminum fins. Dirt may be cleared from the coil by using a water hose directed through the discharge fan grille toward the outside of the unit.
- Have a yearly inspection by a qualified service technician to ensure that the system is performing at its optimal level.

FIGURES & DIAGRAMS

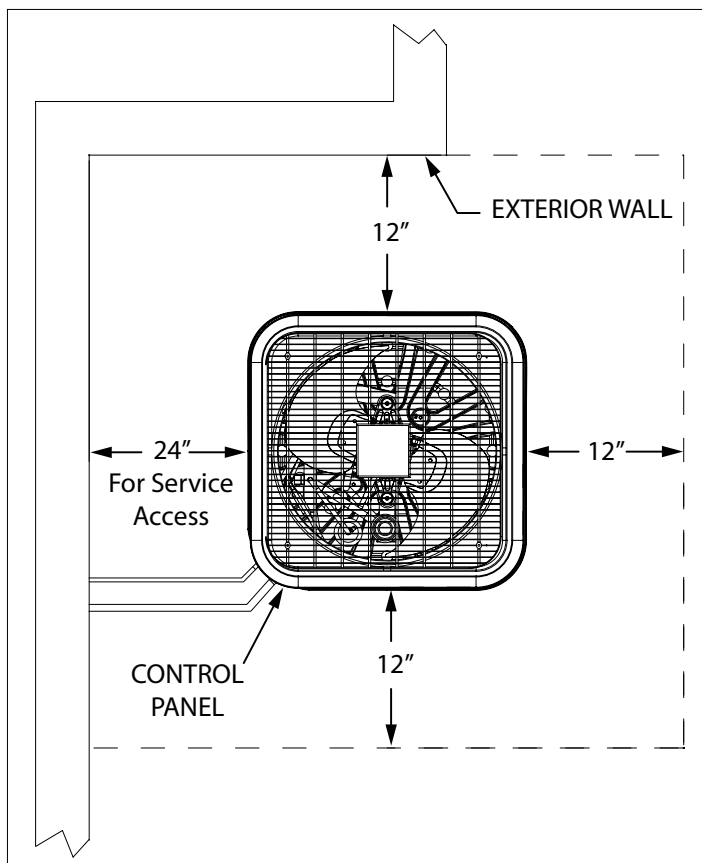

Figure 1. Unit Envelope Dimensions

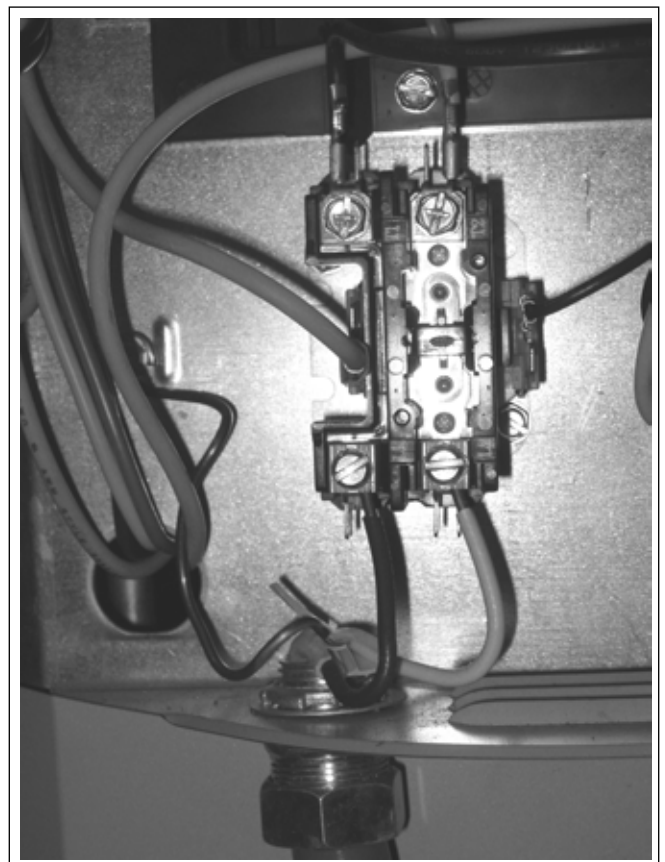
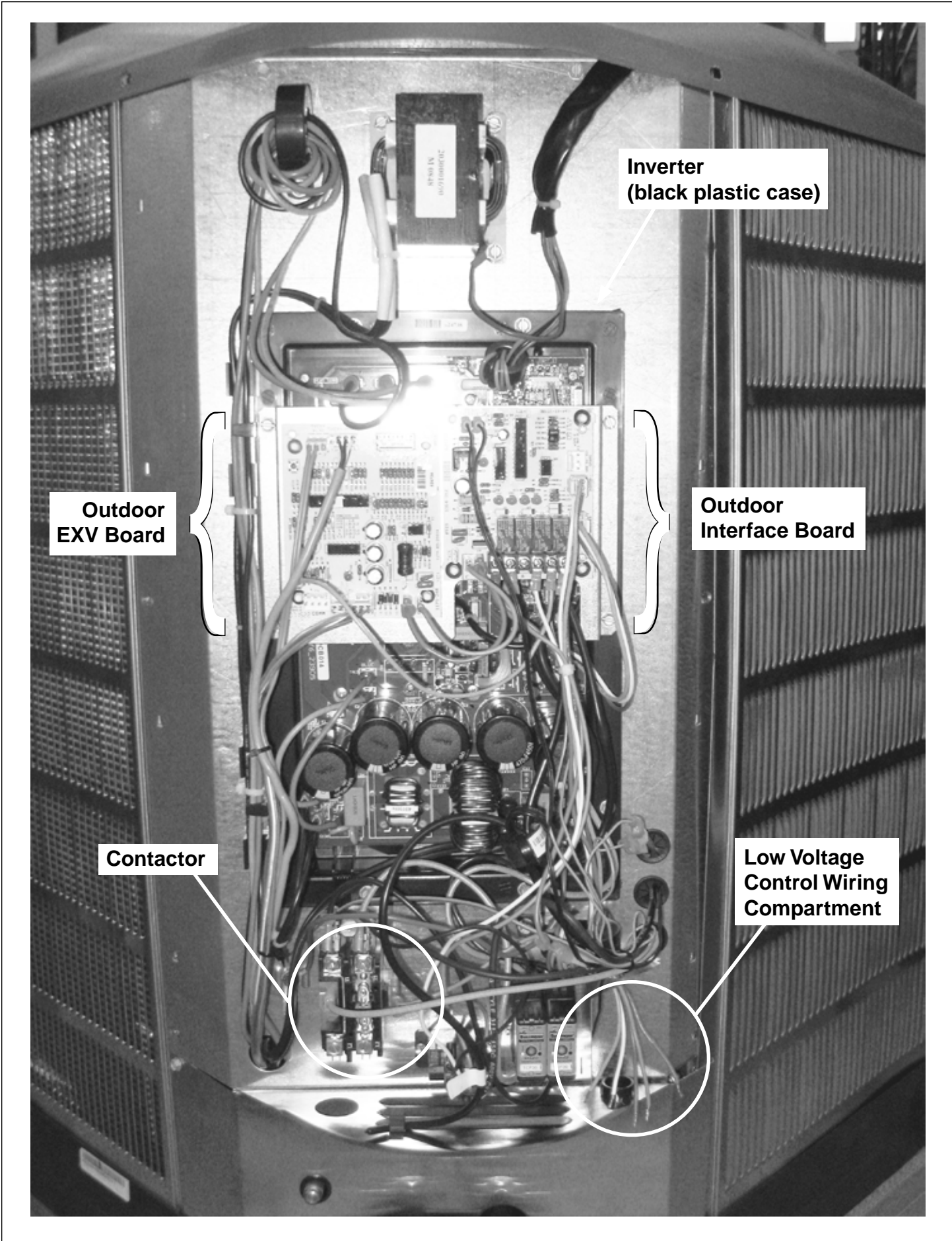

Figure 2. Power Wiring Connections



**Inverter
(black plastic case)**

**Outdoor
EXV Board**

**Outdoor
Interface Board**

Contactor

**Low Voltage
Control Wiring
Compartment**

Figure 3. iQ Drive Heat Pump Control Panel

iQ DRIVE - HEAT PUMP (OUTDOOR SECTION)

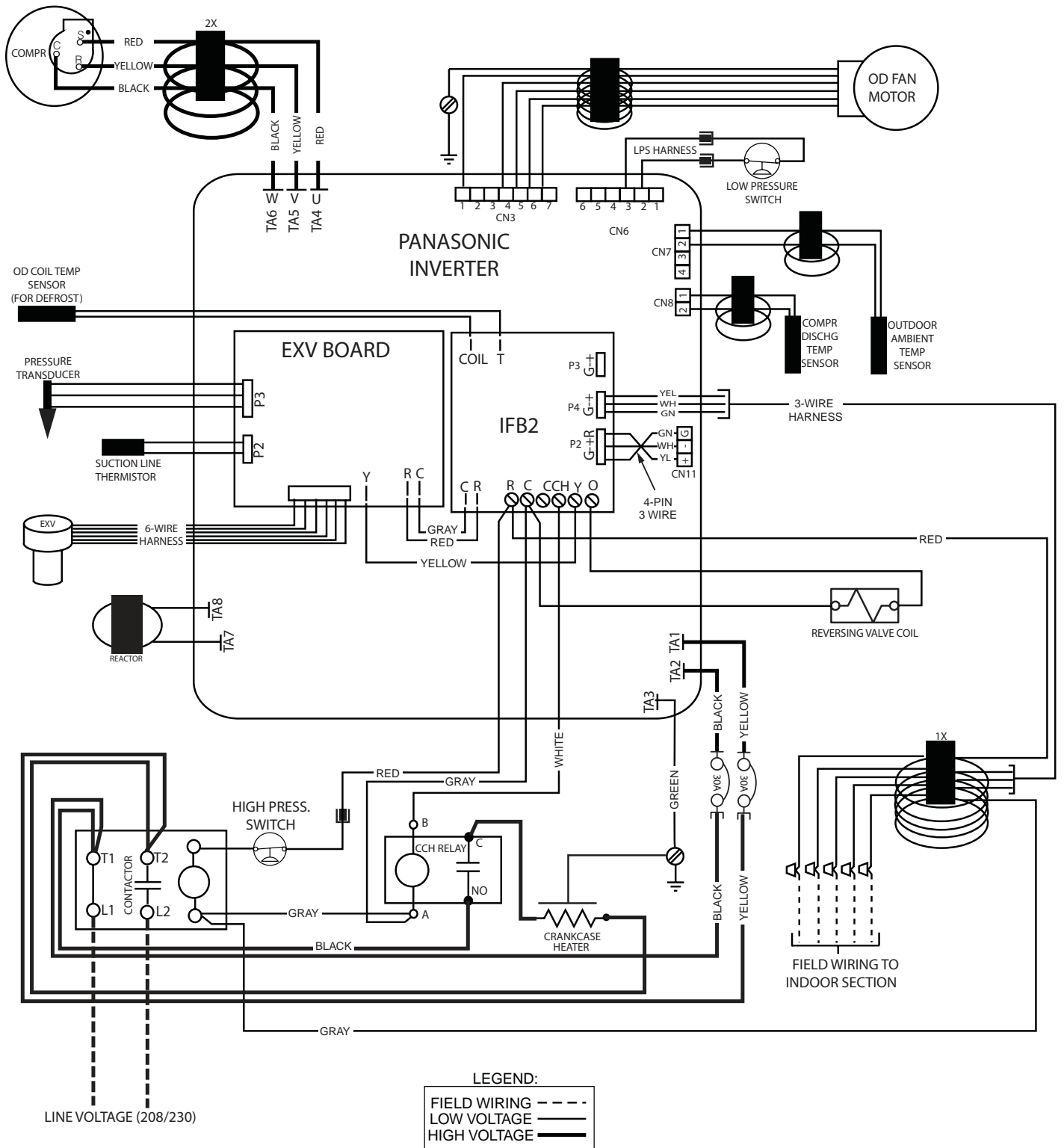

Figure 4. iQ Heat Pump Wiring Diagram



Figure 5. Low Voltage Compartment Control Wiring Connections

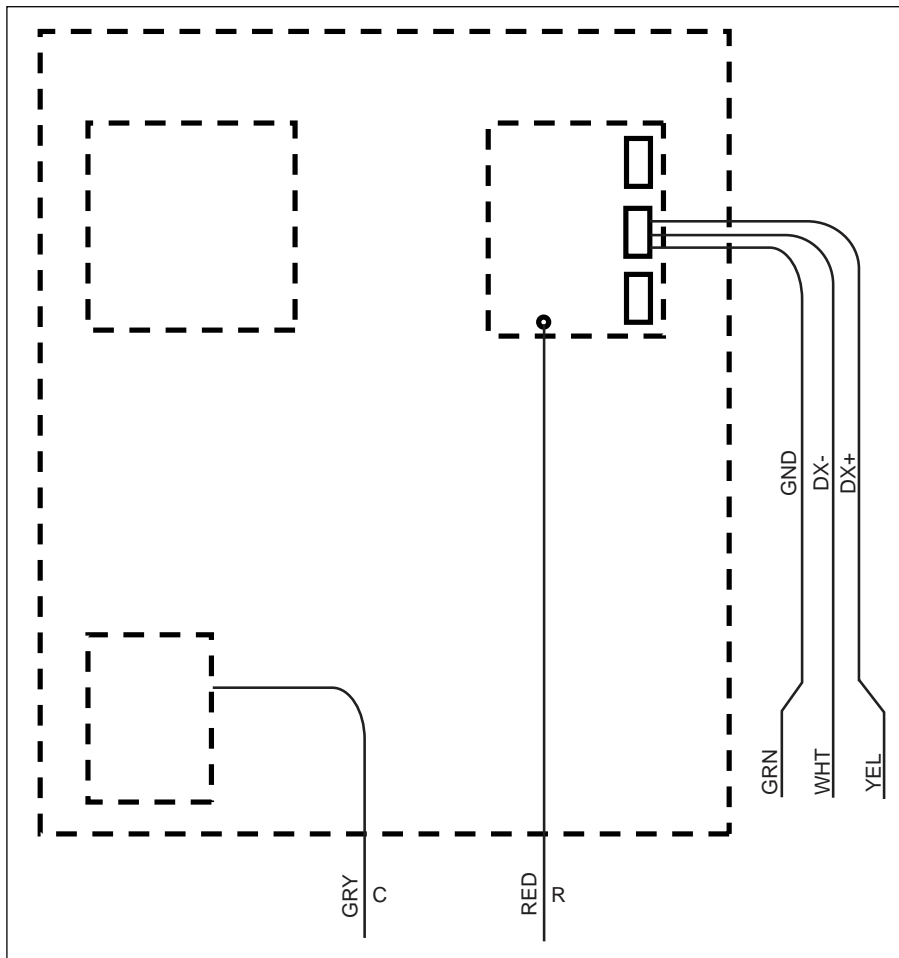

Figure 6. iQ Heat Pump Control Wiring Outdoor Destinations

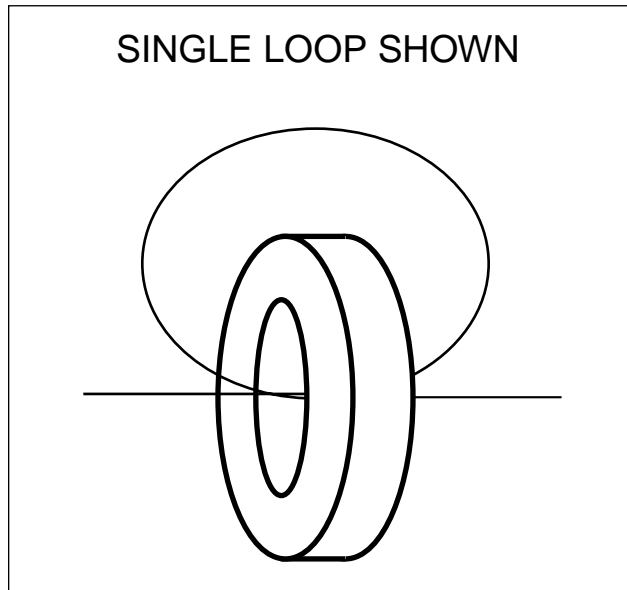

Figure 7. Wire Looping Through a Toroidal Choke

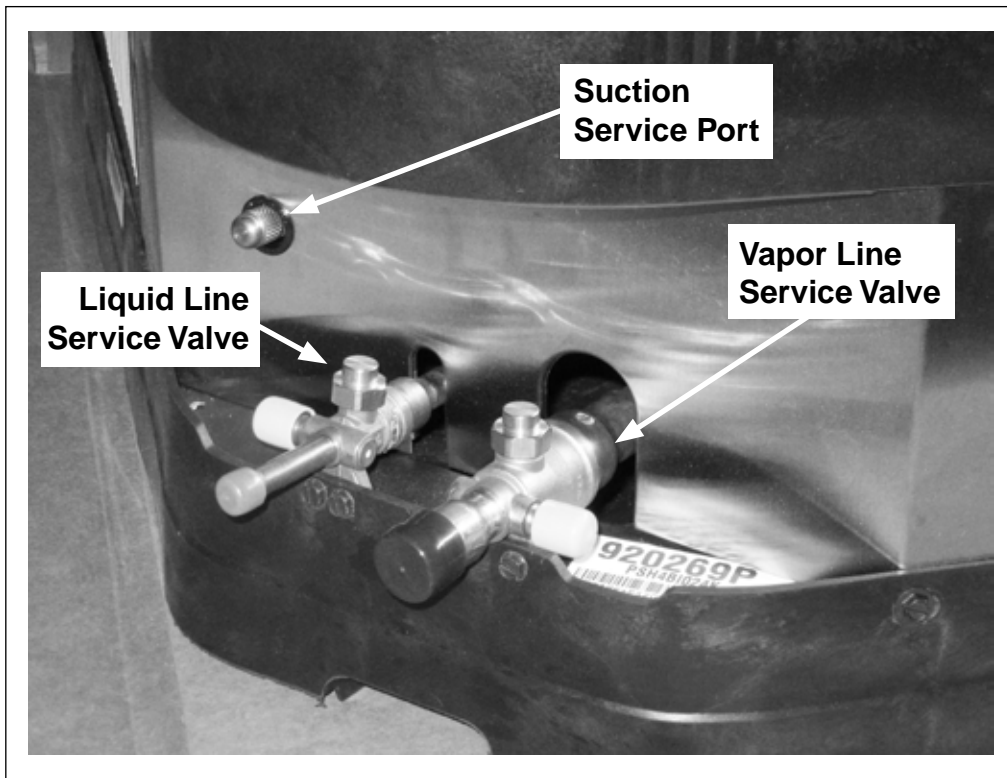
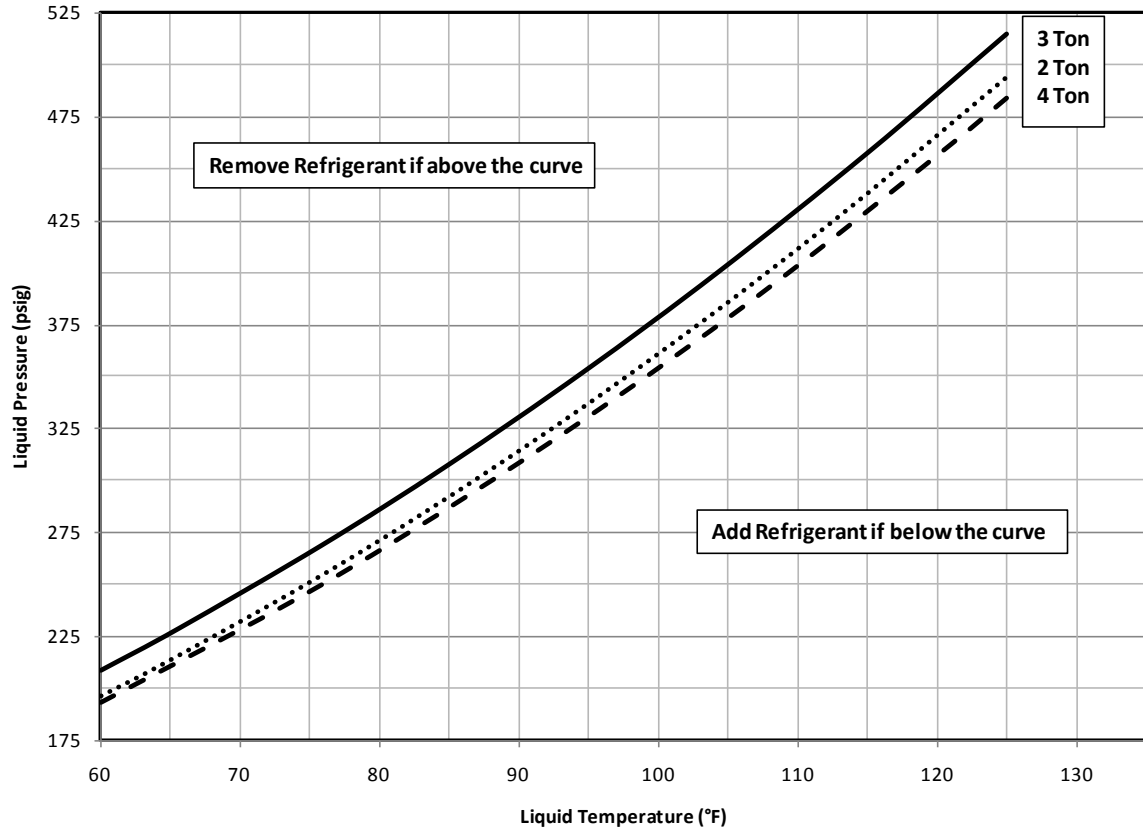

Figure 8. Service Ports and Valves (Below Control Panel)

Cooling Mode

(Outdoor Temperature above 60 °F)



Heating Mode

(Outdoor Temperature below 60 °F)

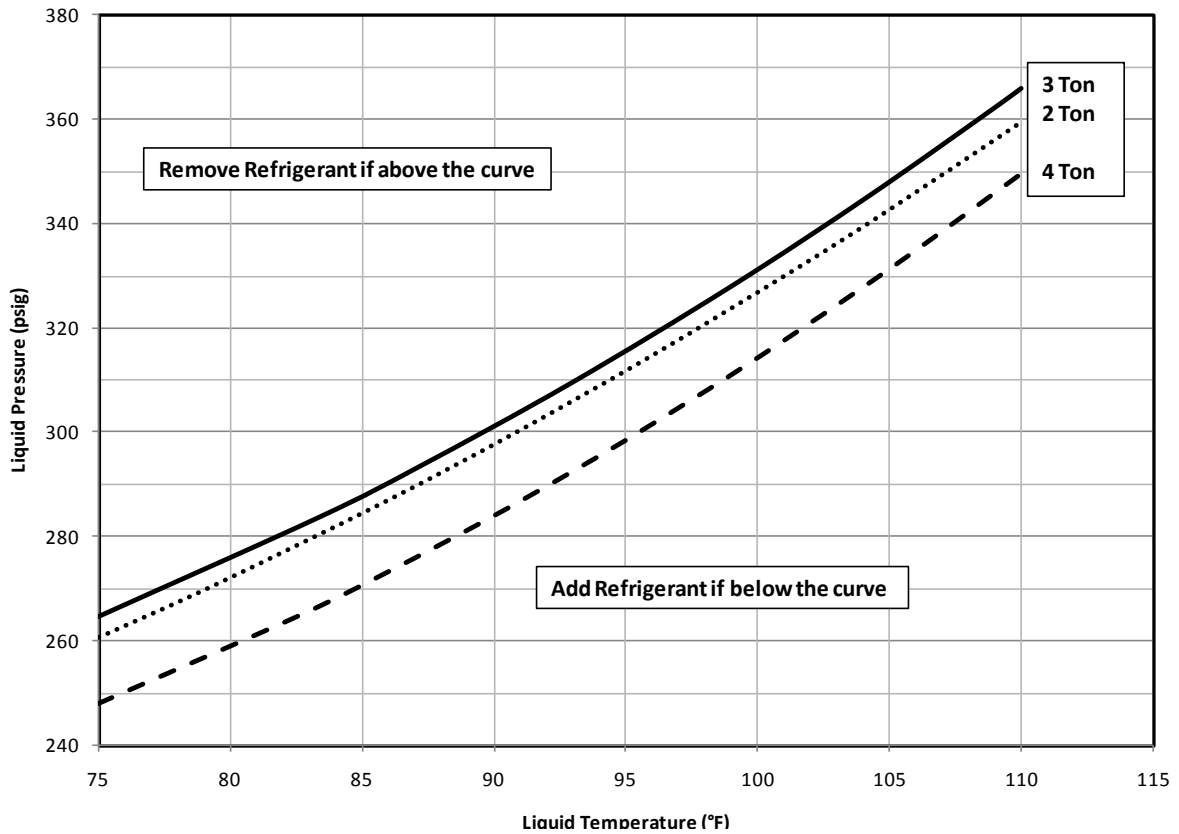
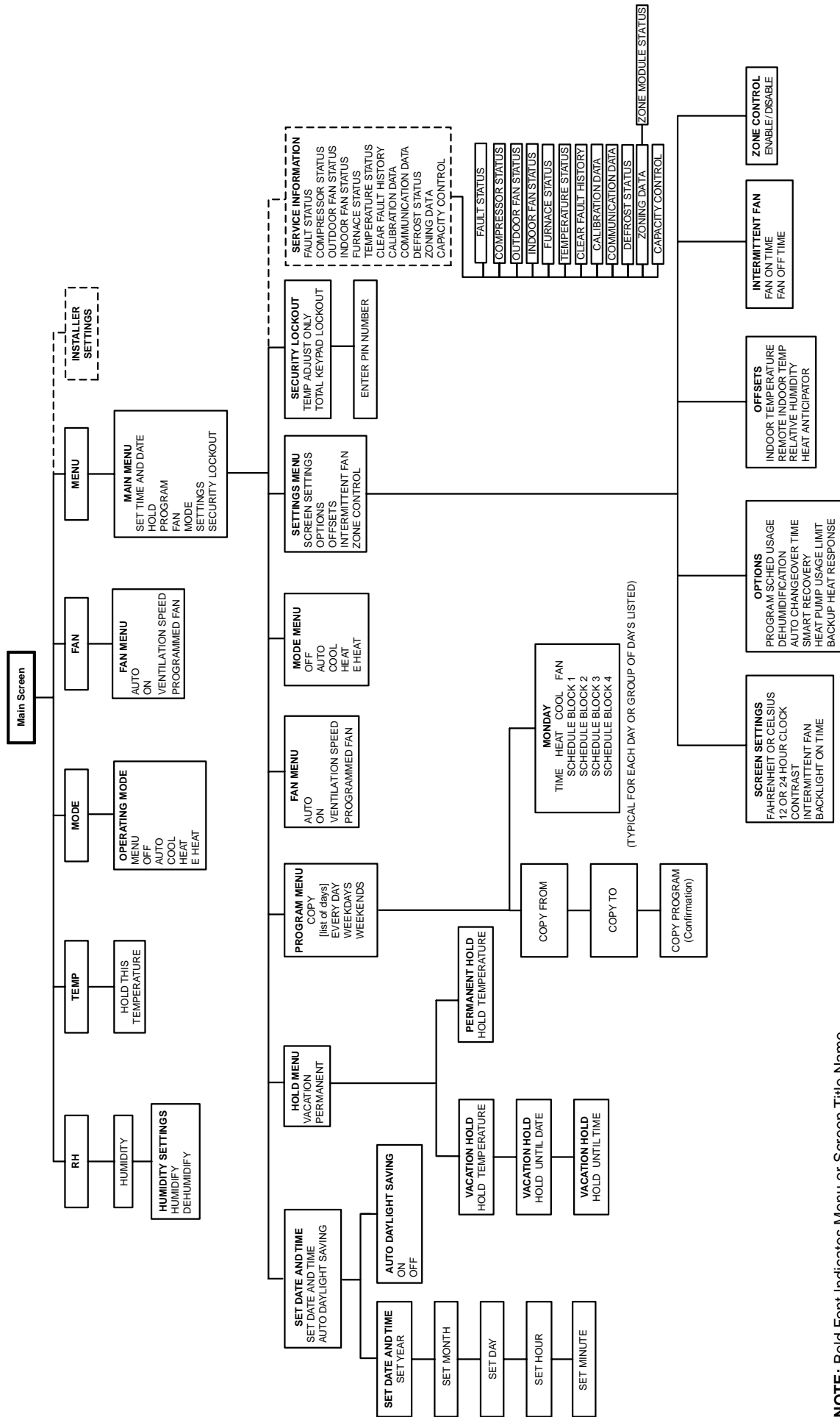
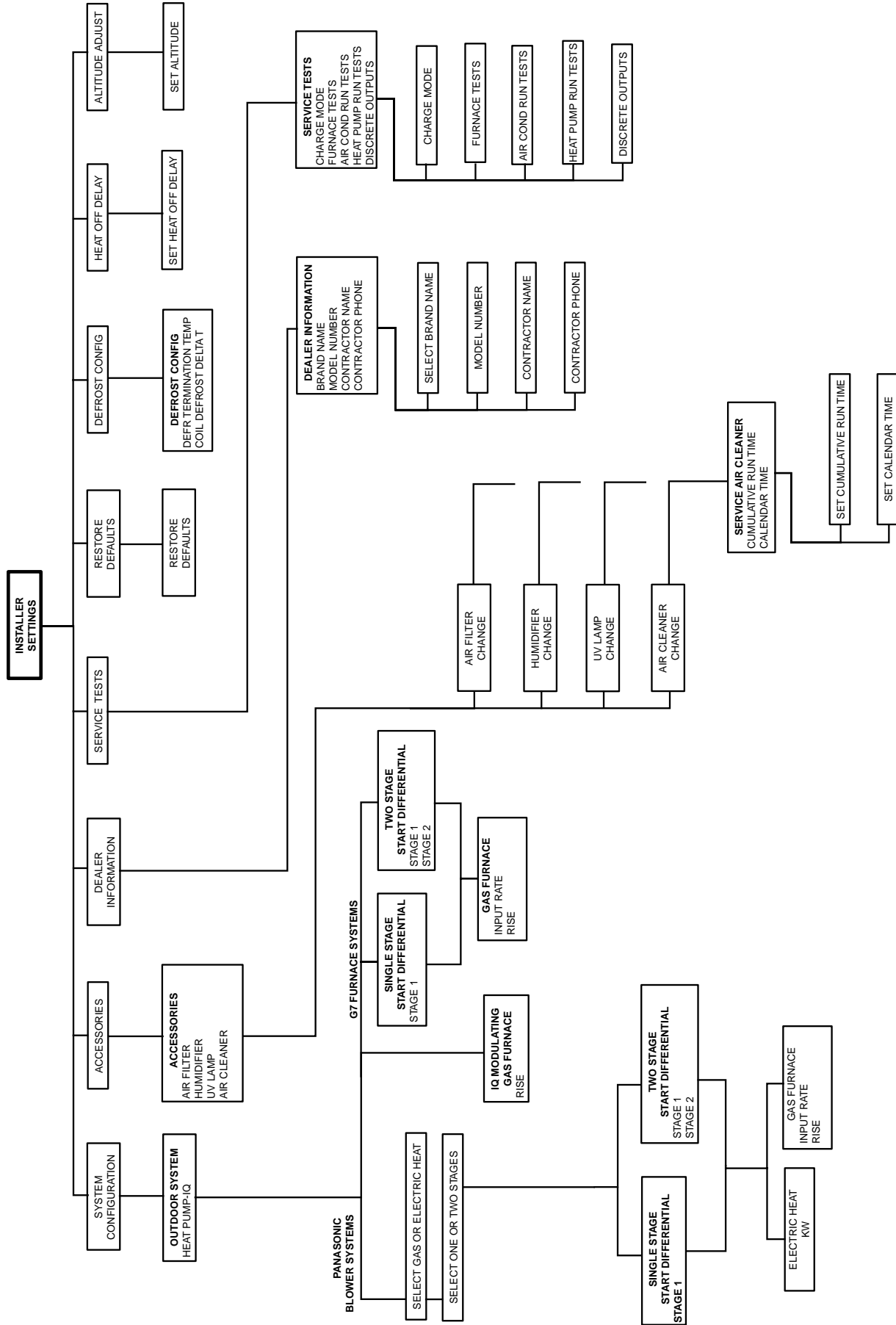

Figure 9. Charging Charts for iQ Heat Pump



NOTE: Bold Font Indicates Menu or Screen Title Name

Figure 10. Controller Menu Structure: Main Screen



(TYPICAL FOR ALL 4 ACCESSORIES)

Figure 11. Controller Menu Structure: Installer Settings

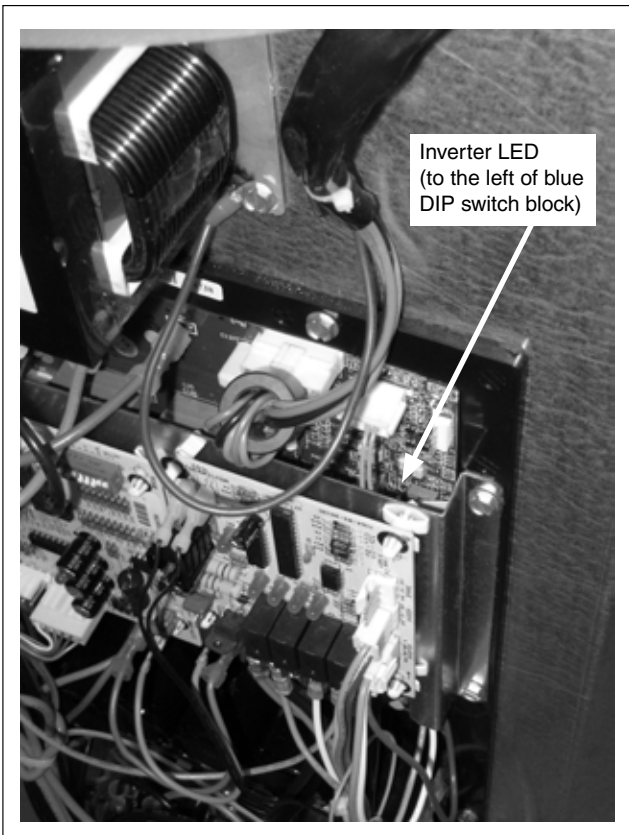

Figure 12. Inverter LED Location
(Behind Interface Board, to the left of
blue DIP switch block)

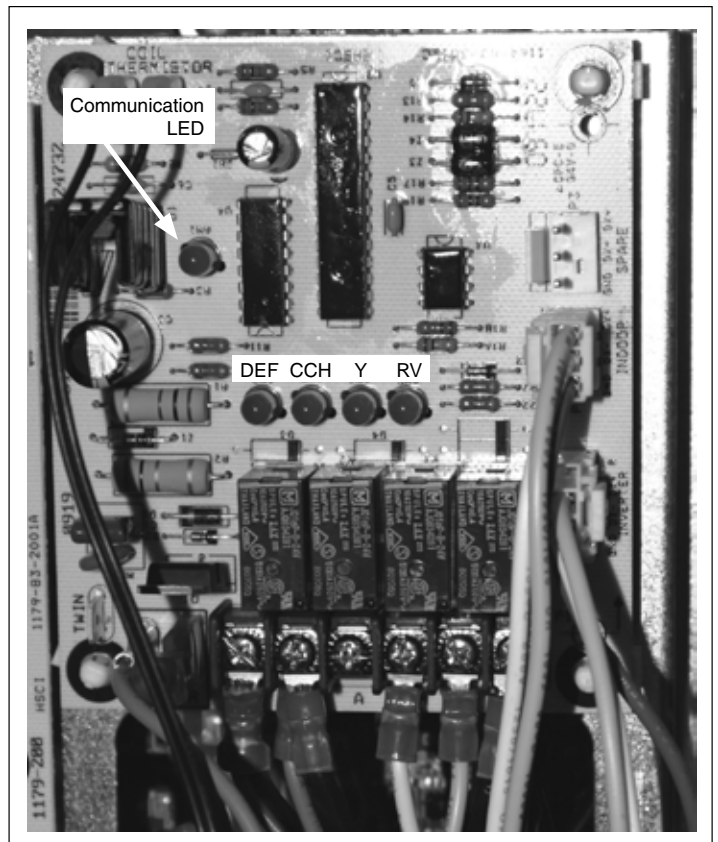

Figure 13. Interface Board LED Locations

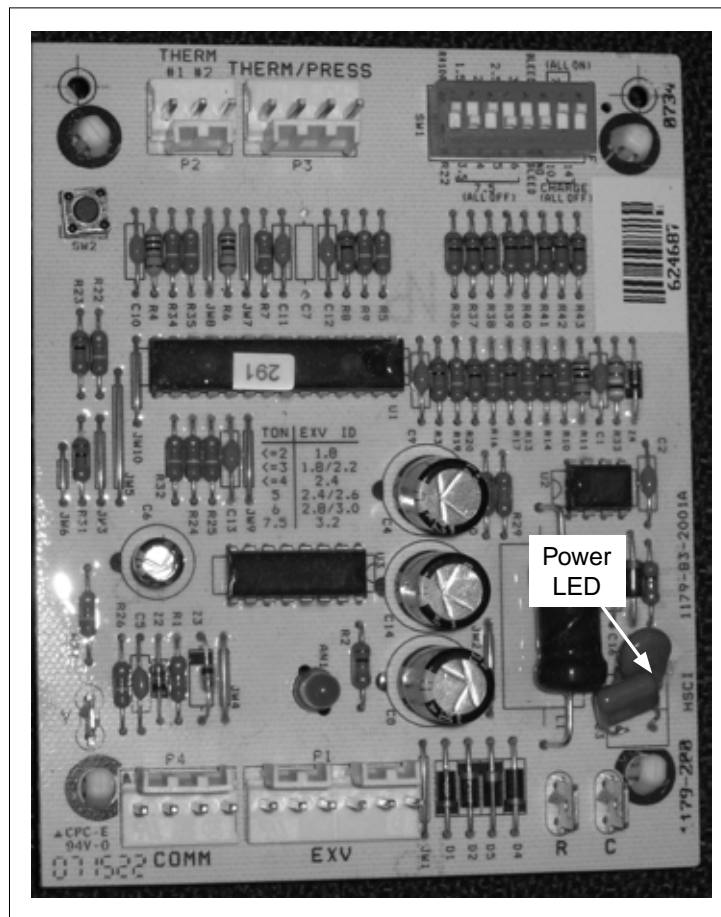

Figure 14. EXV Board Green LED Location

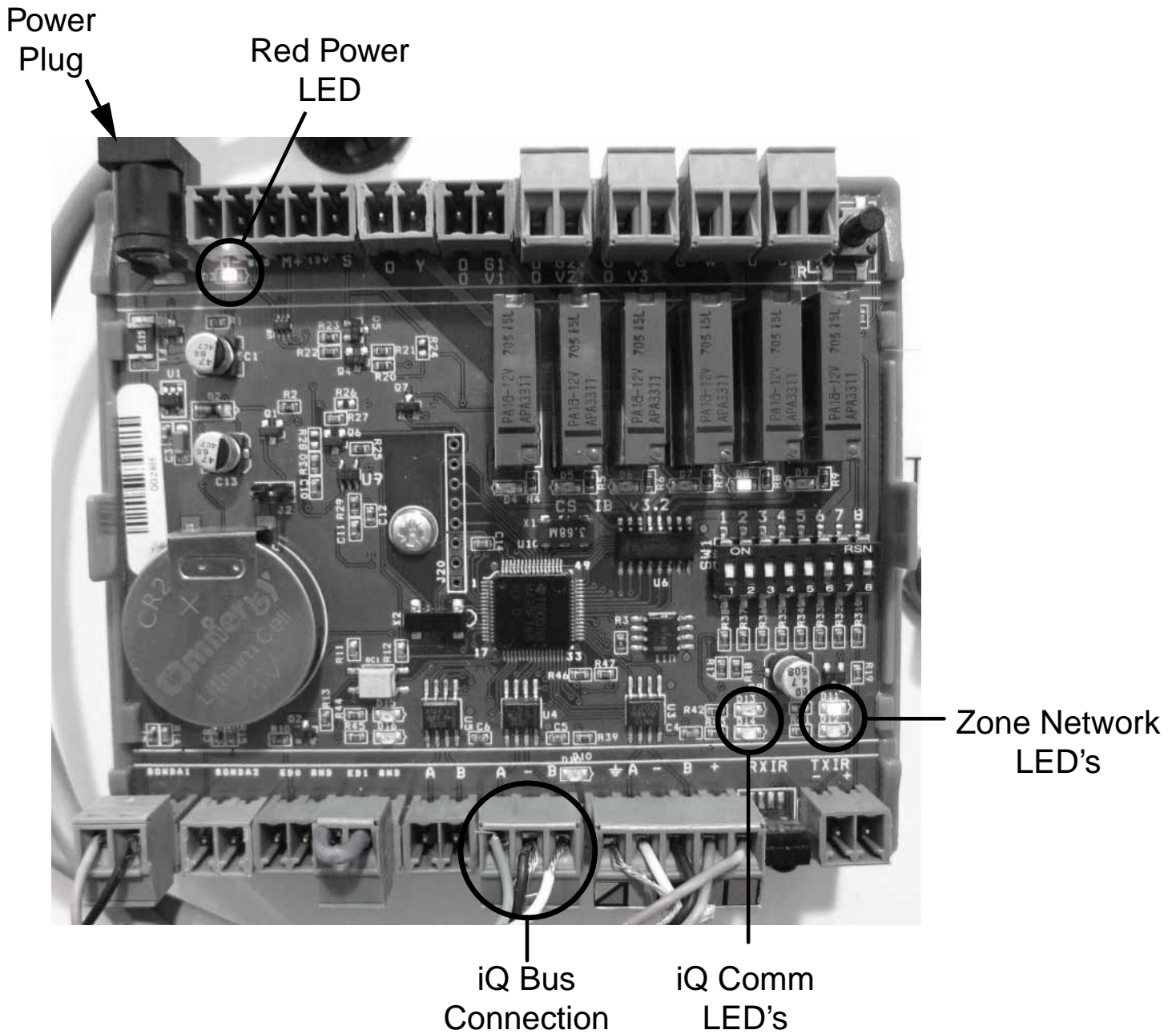

Figure 15. iQ Control Board LED locations

**INSTALLER: PLEASE LEAVE THESE
INSTALLATION INSTRUCTIONS WITH THE OWNER.**

