

90+ Variable Speed Two-Stage Heating Furnace

FLEXIBILITY

- Supports two-stage cooling units
- Dual Certified venting (1 or 2 pipe), Direct Vent Furnace
- 40" (1016mm) high with wider cabinets, for ease of installation
- Factory shipped for natural gas, with Propane Gas conversion kits available
- Four position - upflow/downflow/horizontal installation
- Vent pipe can be run horizontally or vertically
- Internal condensate drain system

SERVICE

- Self diagnostics
- Entire blower assembly removable

COMFORT

- Adjustable timed blower heating Off delay
- Adjustable timed blower cooling On/Off delay
- Thermal lined, one piece steel cabinet for noise reduction
- Insulated blower compartment
- 24 and 115VAC humidifier terminals
- Electronic air cleaner terminal
- Dehumidification option

EFFICIENCY

- 92.1% AFUE
- Two-stage operation
- ECM Variable speed DC motor
- Two-stage Induced draft blower
- In-shot burners

QUALITY

- RPJ III Stainless steel heat exchanger
- Stainless steel secondary heat exchanger
- High temperature limit control prevents overheating
- Direct ignition with Silicon Nitride igniton
- Flame roll-out sensors standard
- External filter rack with permanent filters
- Stainless steel solid doors

WARRANTY *

- 10 year No Hassle Replacement™ limited warranty
 - Lifetime heat exchanger limited warranty with timely registration
 - 5 year parts limited warranty
 - With timely registration, an additional 5 year parts limited warranty
- * Applies to original purchaser/homeowner, some limitations may apply. See warranty certificate for complete details.



Illustrations and photographs are only representative. Some product models may vary.

WARNING

This furnace is not designed for use in mobile homes, trailers, or recreational vehicles. Such use could result in property damage and/or death.

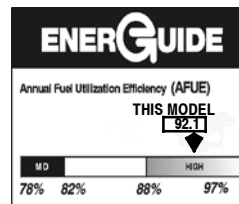

As an Energy Star® Partner, International Comfort Products has determined that this product meets the ENERGY STAR® guidelines for energy efficiency. Ask your contractor for details or visit www.energystar.gov



UPFLOW/DOWNFLOW/HORIZONTAL (NATURAL GAS)							
Model Number	Dimensions H x W x D		Input (MBTUH)	Efficiency AFUE	Cooling Capacity @ .5 in wc (125 Pa)	Shipping Wt.	
	Inches	Millimeters				Lbs	Kg
T9MPV050F12D	40 x 19 ¹ / ₈ x 29	1016 x 486 x 737	50	92.1	1.5 - 3.0 TON	150	68
T9MPV075F12D	40 x 19 ¹ / ₈ x 29	1016 x 486 x 737	75	92.1	1.5 - 3.5 TON	168	76
T9MPV100J20D	40 x 22 ³ / ₄ x 29	1016 x 578 x 737	100	92.1	3 - 5.0 TON	187	85
T9MPV125L20D	40 x 24 ¹ / ₂ x 29	1016 x 522 x 737	125	92.1	3 - 5.0 TON	203	92

FURNACE SPECIFICATIONS

Model Number * Denotes Brand (C, H, T)	*9MPV050F12	*9MPV075F12	*9MPV100J20	*9MPV125L20
INPUT HIGH HEAT (BTUH) LOW HEAT (BTUH)	50,000 35,000	75,000 52,500	100,000 70,000	125,000 87,500
HTG. CAP. HIGH HEAT (BTUH) LOW HEAT (BTUH)	46,000 32,000	70,000 48,000	93,000 65,000	118,000 82,000
AFUE % (ICS)	92.1	92.1	92.1	92.1
TEMP. RISE RANGE High Heat (°F/°C) Low Heat (°F/°C)	35-65/19-36 35-65/19-36	40-70/22-39 40-70/22-39	40-70/22-39 40-70/22-39	40-70/22-39 40-70/22-39
VENT SIZE [^] - in(mm)	2" (50.8) OD	2" - 3" (50.8 or 76.2) OD	3" (76.2) OD	3" (76.2) OD
VOLTS/HZ/PH	115/60/1	115/60/1	115/60/1	115/60/1
RATING PLATE AMPS.	9.5	11.4	14.6	15.4
MIN./MAX. VOLTAGE	104/127	104/127	104/127	104/127
TRANSFORMER (V.A.)	40	40	40	40
GAS PIPE SIZE - in(mm)	1/2 (12.7)	1/2 (12.7)	1/2 (12.7)	1/2 (12.7)
COOLING CAP. (TONS)	3.0	3.0	5.0	5.0
HIGH ALTITUDE PRESSURE SWITCH	1013165	1013165	1013165	1013157
FILTER SIZE - in(mm)	16X25X1 (406x635x25) (1)	16X25X1(406x635x25) (1)	16X25X1(406x635x25) (2)	16X25X1(406x635x25) (2)
DIMENSIONS W x D x H - in(mm)	19 1/8 x 29 x 40 (486 x 737 x 1016)	19 1/8 x 29 x 40 (486 x 737 x 1016)	22 3/4 x 29 x 40 (486 x 737 x 1016)	24 1/2 x 29 x 40 (622 x 737 x 1016)
WEIGHT - Lbs. (Kg)	150 (68)	168 (76)	187 (85)	203 (92)

[^] Vent size may vary depending on length, number of elbows, standard vent or direct vent. See Installation Instructions.

Cabinet to Combustible Clearances - in(mm)

TOP	BOT	RH	LH	BACK	FRNT	FLUE
1 (25.4)	0	0	0	0	3(76.2)	0

*30" (762mm) clearance recommended for furnace removal.

Horizontal position: Line contact is permissible only between lines formed by intersections of top and two sides of furnace jacket, and building joists, studs or framing.

NOTE: Evaporator "A" coil drain pan dimensions may vary from furnace duct opening size. Always consult evaporator specifications for duct size requirements. Furnace is designed for bottom return or side return. Return air through back of furnace is NOT allowed.

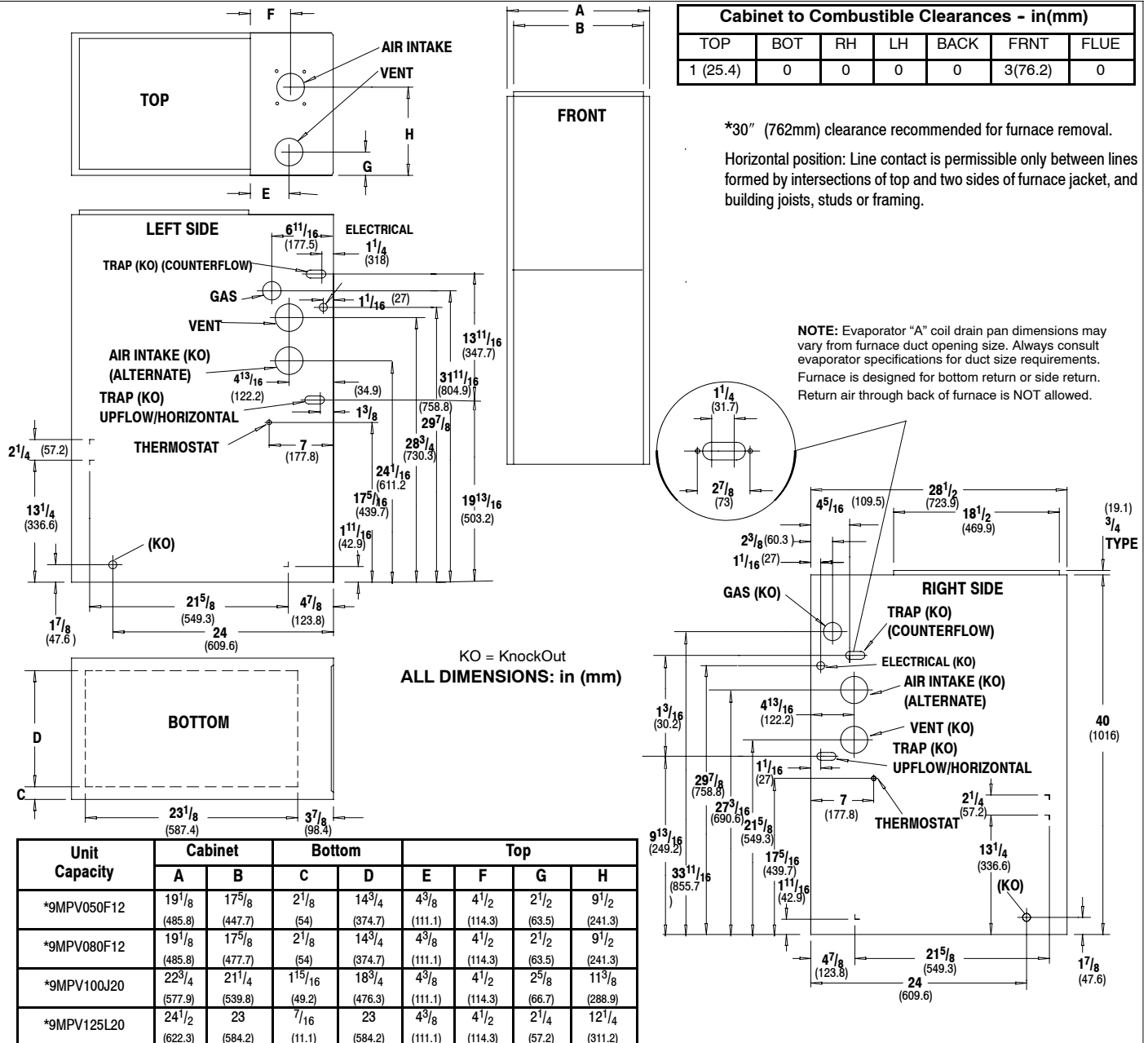

KO = KnockOut
ALL DIMENSIONS: in (mm)

Unit Capacity	Cabinet		Bottom		Top			
	A	B	C	D	E	F	G	H
*9MPV050F12	19 1/8 (485.8)	17 5/8 (447.7)	2 1/8 (54)	14 3/4 (374.7)	4 3/8 (111.1)	4 1/2 (114.3)	2 1/2 (63.5)	9 1/2 (241.3)
*9MPV080F12	19 1/8 (485.8)	17 5/8 (447.7)	2 1/8 (54)	14 3/4 (374.7)	4 3/8 (111.1)	4 1/2 (114.3)	2 1/2 (63.5)	9 1/2 (241.3)
*9MPV100J20	22 3/4 (577.9)	21 1/4 (539.8)	1 15/16 (49.2)	18 3/4 (476.3)	4 3/8 (111.1)	4 1/2 (114.3)	2 5/8 (66.7)	11 3/8 (288.9)
*9MPV125L20	24 1/2 (622.3)	23 (584.2)	7/16 (11.1)	584.2 (584.2)	4 3/8 (111.1)	4 1/2 (114.3)	2 1/4 (57.2)	12 1/4 (311.2)

* Denotes Brand

Drawing is representative, but some models may vary

MODEL NUMBER IDENTIFICATION GUIDE

Brand Identifier * = Brand								Engineering Rev. Denotes minor changes
Model Efficiency 8 = Non-Condensing, 80+% Gas Furnace 9 = Condensing, 90+% Gas Furnace								Marketing Digit Denotes major change
Installation Configuration UP = Upflow DN = Downflow UH = Upflow/Horizontal HZ = Horizontal DH = Downflow/Horizontal MP = Multiposition, Up/Down/Horizontal								Cooling Airflow 08 = 800 CFM 12 = 1200 CFM 14 = 1400 CFM 16 = 1600 CFM 20 = 2000 CFM
Major Design Feature 1 = One (Single) Pipe N = Single Stage 2 = Two Pipe P = PVC Vent D = 1 or 2 Pipe T = Two Stage L = Low NOx V = Variable Speed								Cabinet Width B = 15.5" Wide F = 19.1" Wide J = 22.8" Wide L = 24.5" Wide
								Input (Nominal MBTUH)

* Denotes Brand (C, H, T)

ACCESSORIES

Model Number	Description	Used With Models
NAHA002NG 1172961**	Gas Conversion Kits (2-Stage) - Propane to natural gas conversion kit. Allows field conversion to natural gas.	*9MPV
NAHA002LP 1172959 **	Gas Conversion Kits (2-Stage) - Natural gas to Propane conversion Kit (includes low pressure switch). Allows field conversion to Propane gas.	*9MPV
NAHA001FF	Filter Kits - External filter frame. 16" x 25" (406mm x 635mm)	Side Return (All Furnaces) Bottom Return (All "F" 19 ¹ / ₈ " Furnaces under 1600 CFM)
NAHA001FP	External filter frame. 16" x 25" (406mm x 635mm) Bulk Pack Kit - Qty 10	
NAHA002FF	Filter Kits - Bottom return filter frame kit 20" x 25"	(All "J" 22 ³ / ₄ " Furnaces)
NAHA002FP	Bottom return filter frame kit 20" x 25" (508mm x 635mm) Bulk Pack Kit - Qty 10	
NAHA001TK	Duct Standoff Filter Kit - To adapt 20" x 25" (508mm x 635mm) filter for single side return.	Side Return (All single return applications with 1600 CFM or greater) Bottom Return (All "F" 19 ¹ / ₈ " Furnaces under 1600 CFM)
NAHA001NK 612833**	Condensate Neutralizer Kit - for condensing gas furnaces	All *9MPV Furnaces if Required
NAHH002SB	Combustible Floor Subbase - Subbase Furnace ONLY: All 19 ¹ / ₄ " wide furnace models	*9MPV050/075
NAHH003SB	Combustible Floor Subbase - Subbase Furnace ONLY: All 22 ³ / ₄ " wide furnace models	*9MPV100
NAHH010SB	Combustible Floor Subbase - Subbase Furnace ONLY: All 24 ¹ / ₂ " wide furnace models	*9MPV125
NAHH005SB	Subbase - Furnace w/ 19 ¹ / ₄ " cased coil	*9MPV050/075 Counterflow furnace w/19 ¹ / ₄ " cased coil
NAHH006SB	Subbase - Furnace w/ 22 ³ / ₄ " cased coil	*9MPV100 Counterflow furnace w/22 ³ / ₄ " cased coil
NAHH009SB	Subbase Furnace w/ 24 ¹ / ₂ " cased coil	*9MPV125 Counterflow furnace w/24 ¹ / ₂ " cased coil
1013165**	High Altitude Pressure Switch Kit	*9MPV050, 075 & 100
1013157**	High Altitude Pressure Switch Kit	*9MPV125
NAHA001CV 1011129**	3" (76.2mm) Concentric Vent Kit - allows single wall penetration for 2 pipe direct vent applications (90+).	*9MPV100/125
NAHA002CV	2" (50.8mm) Concentric Vent Kit - allows single wall penetration for 2 pipe direct vent applications (90+).	*9MPV050/075
NAHA001CA	Coil Adapter for Downflow Furnaces	
NAHA002WL	To replace Warning Labels, Operating Instructions & Wiring Labels on Blower Door when needed	*9MPV

* Denotes Brand (C, H, T)

** Fast part number

Circulation Air Blower Data - *9MPV050

Cooling Adjustment					** Adjust Jumper Setting	Heating Rise Adjustment		
DIP Switch (OFF = 0 ON = 1)	High Cool @ .50 in wc(125 Pa)		Low Cool (80% of High Cool)			DIP Switch (OFF = 0 ON = 1)	High Heat Rise Change @ 0.20 in wc (50 Pa)	Low Heat Rise Change at Resultant Static
	5 & 6	CFM	L/s	CFM				
00	1246	588	997	471	+	00	-4	-3
*00	1211	571	969	457	*NOM	*00	0	0
00	1122	529	898	424	-	00	5	5
01	1105	521	884	417	+	01	3	4
01	1027	485	822	388	NOM	01	7	7
01	945	446	756	357	-	01	13	14
10	892	421	714	337	+	10	-1	0
10	820	387	656	310	NOM	10	4	5
10	745	352	596	281	-	10	9	9
11	688	325	550	260	+	11	-15	-15
11	609	287	487	230	NOM	11	-13	-12
11	541	255	433	204	-	11	-9	-9

Airflow performance includes 1" washable filter media.

*Factory Setting

**Adjust Jumper Setting (+, NOM, -) is applied to both Cooling and Heating

Note 1: HP Mode Jumper provides a 10% reduction in airflow when in Comfort position and a call for low or high cooling is present with the "O" line off. This feature is to provide lower airflow for running in HP Heating Mode if desirable.

Note 2: DEHUM mode (24VAC on DEHUM terminal) provides a 20% airflow reduction during cooling calls.

Note 3: Low Heat ESP is a result of High Heat ESP (- is decrease in rise).

Note 4: High and low heat rise values are approximate air temperature change from return air temperature when at factory default settings.

Table 2	Airflow	
DIP Switch (OFF = 0 / ON = 1)	Continuous Fan @ 0.10 in wc (25 Pa) ESP	
1 & 2	CFM	L/s
*00	592	279
01	1021	482
10	1346	635
11	1346	635

Table 3	SW2 DIP Assignments
DIP Switch	Blower Parameter
1 & 2	Cont Fan Adj
3 & 4	Heat Speed Adj
5 & 6	Cool Speed Adj
7 & 8	Cool On/Off Delay

* Factory Setting

Table 4	Cooling Delay Options (SW2 - 7, 8)			
	ON DELAY		OFF DELAY	
DIP SW2 - 7/8 (OFF = 0 / ON = 1)	Timed ON (sec)	Airflow during on delay	Timer OFF (sec)	Airflow during off delay
*00	5	OFF	90	100%
01	5	OFF	0	OFF
10	30	50%	30	100%
11	30	50%	180	50%

Airflow % is of High Cool airflow demand determined from SW2-5/6 Table 1

Airflow resumes to 100% after on delay time is completed

Airflow stops (or switches to continuous fan speed) after off delay time is completed

* Factory Setting

MAX CFM (L/s) for Factory Washable Filters		
Filter Size (in/mm)	CFM	L/s
14" X 25" (356 x 635)	1400	661
16" X 25" (406 x 635)	1600	755
20" X 25" (508 x 635)	2000	944
24" X 25" (610 x 635)	2500	1180
Max CFM (L/s) based on 600 FPM (3.0 M/s)		

NOTE: Disposable filters are typically rated at 300 FPM (1.5 M/s). These filters only allow half the airflow when compared to 600 FPM (3.0 M/s) filters.

EXAMPLE (approx.):

20in X 25in @ 600 FPM = 2000 CFM, @ 300 FPM = 1000 CFM
508mm x 635mm @ 3.0 M/s = 944 L/s, @ 1.5 M/s = 472 L/s

Circulation Air Blower Data - *9MPV050

Cooling Airflow Settings

High Cooling Airflows *9MPV050F12

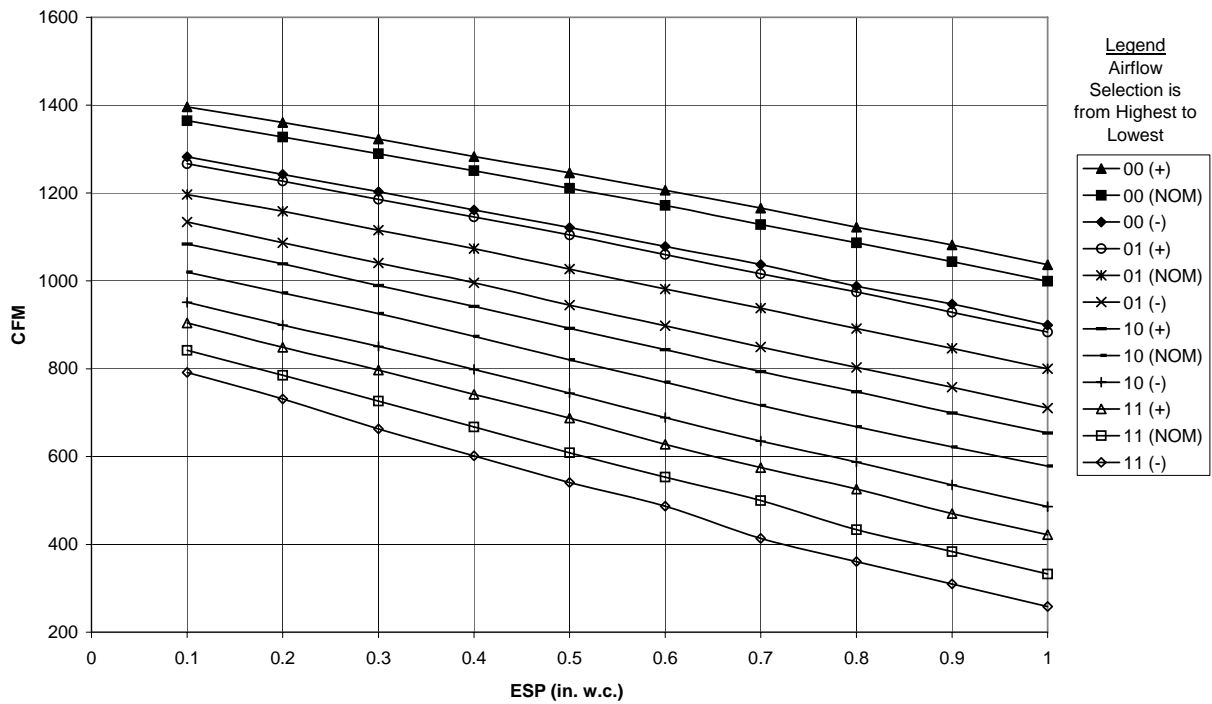

Low Cooling Airflows *9MPV050F12

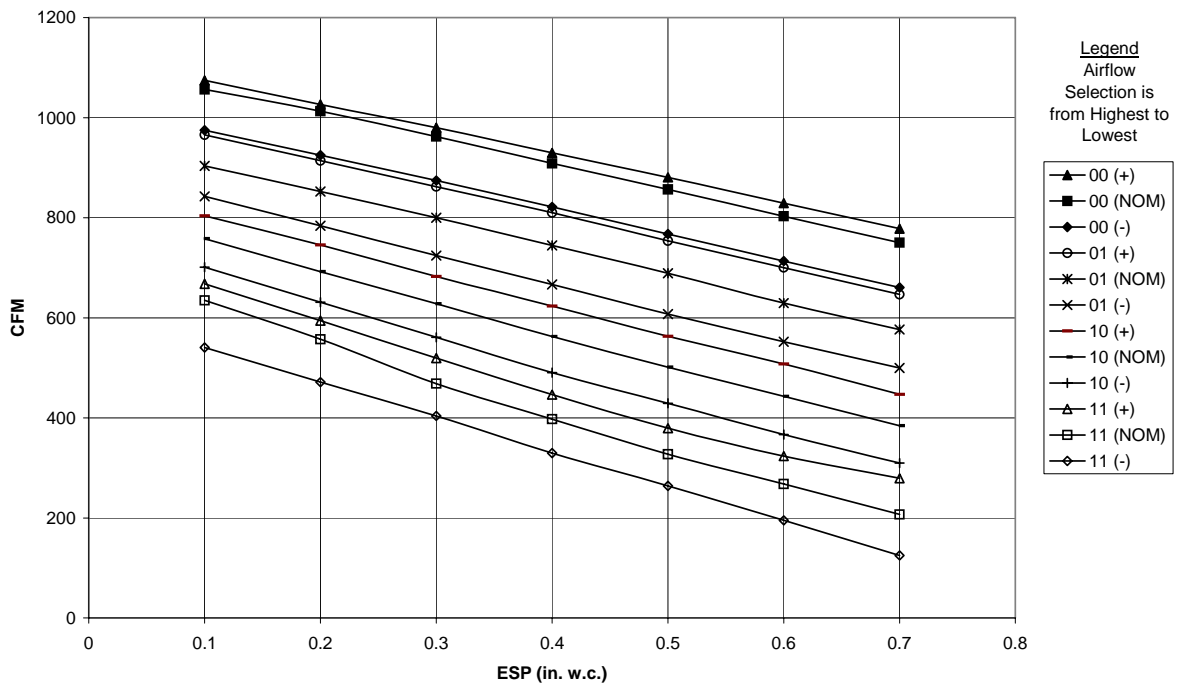

NOTE: OFF = 0 / ON = 1

Circulation Air Blower Data - *9MPV075

Cooling Adjustment					** Adjust Jumper Setting	Heating Rise Adjustment		
DIP Switch (OFF = 0 ON = 1)	High Cool @ .50 in wc(125 Pa)		Low Cool (80% of High Cool)			DIP Switch (OFF = 0 ON = 1)	High Heat Rise Change @ 0.20 in wc (50 Pa)	Low Heat Rise Change at Resultant Static
	5 & 6	CFM	L/s	CFM				
00	1342	633	1074	507	+	00	-4	-4
*00	1210	571	968	457	*NOM	*00	0	0
00	1053	497	842	397	-	00	5	4
01	1135	536	908	429	+	01	1	1
01	1020	481	816	385	NOM	01	6	5
01	872	412	698	329	-	01	12	10
10	965	455	772	364	+	10	-1	-1
10	840	396	672	317	NOM	10	3	3
10	680	321	544	256	-	10	9	8
11	708	334	566	267	+	11	-6	-6
11	590	278	472	223	NOM	11	-2	-3
11	488	230	390	184	-	11	3	2

Airflow performance includes 1" washable filter media.

*Factory Setting

**Adjust Jumper Setting (+, NOM, -) is applied to both Cooling and Heating

Note 1: HP Mode Jumper provides a 10% reduction in airflow when in Comfort position and a call for low or high cooling is present with the "O" line off. This feature is to provide lower airflow for running in HP Heating Mode if desirable.

Note 2: DEHUM mode (24VAC on DEHUM terminal) provides a 20% airflow reduction during cooling calls.

Note 3: Low Heat ESP is a result of High Heat ESP (- is decrease in rise).

Note 4: High and low heat rise values are approximate air temperature change from return air temperature when at factory default settings.

Table 2	Airflow	
DIP Switch (OFF = 0 / ON = 1)	Continuous Fan @ 0.10 in wc (25 Pa) ESP	
1 & 2	CFM	L/s
*00	612	289
01	1096	517
10	1403	662
11	1403	662

Table 3	SW2 DIP Assignments
DIP Switch	Blower Parameter
1 & 2	Cont Fan Adj
3 & 4	Heat Speed Adj
5 & 6	Cool Speed Adj
7 & 8	Cool On/Off Delay

* Factory Setting

Table 4	Cooling Delay Options (SW2 - 7, 8)			
	ON DELAY		OFF DELAY	
DIP SW2 - 7/8 (OFF = 0 / ON = 1)	Timed ON (sec)	Airflow during on delay	Timer OFF (sec)	Airflow during off delay
*00	5	OFF	90	100%
01	5	OFF	0	OFF
10	30	50%	30	100%
11	30	50%	180	50%

Airflow % is of High Cool airflow demand determined from SW2-5/6 Table 1

Airflow resumes to 100% after on delay time is completed

Airflow stops (or switches to continuous fan speed) after off delay time is completed

* Factory Setting

MAX CFM (L/s) for Factory Washable Filters		
Filter Size (in/mm)	CFM	L/s
14" X 25" (356 x 635)	1400	661
16" X 25" (406 x 635)	1600	755
20" X 25" (508 x 635)	2000	944
24" X 25" (610 x 635)	2500	1180
Max CFM (L/s) based on 600 FPM (3.0 M/s)		

NOTE: Disposable filters are typically rated at 300 FPM (1.5 M/s). These filters only allow half the airflow when compared to 600 FPM (3.0 M/s) filters.

EXAMPLE (approx.):

20in X 25in @ 600 FPM = 2000 CFM, @ 300 FPM = 1000 CFM

508mm x 635mm @ 3.0 M/s = 944 L/s, @ 1.5 M/s = 472 L/s

Circulation Air Blower Data - *9MPV075

Cooling Airflow Settings

High Cooling Airflows
*9MPV075F12

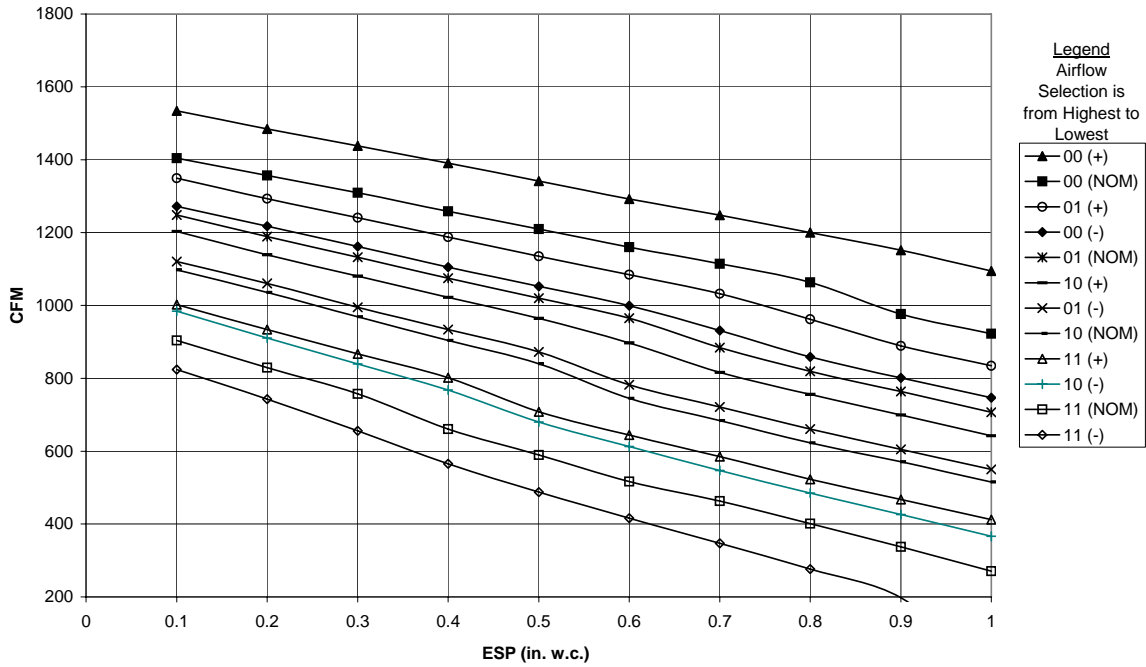

Low Cooling Airflows
*9MPV075F12

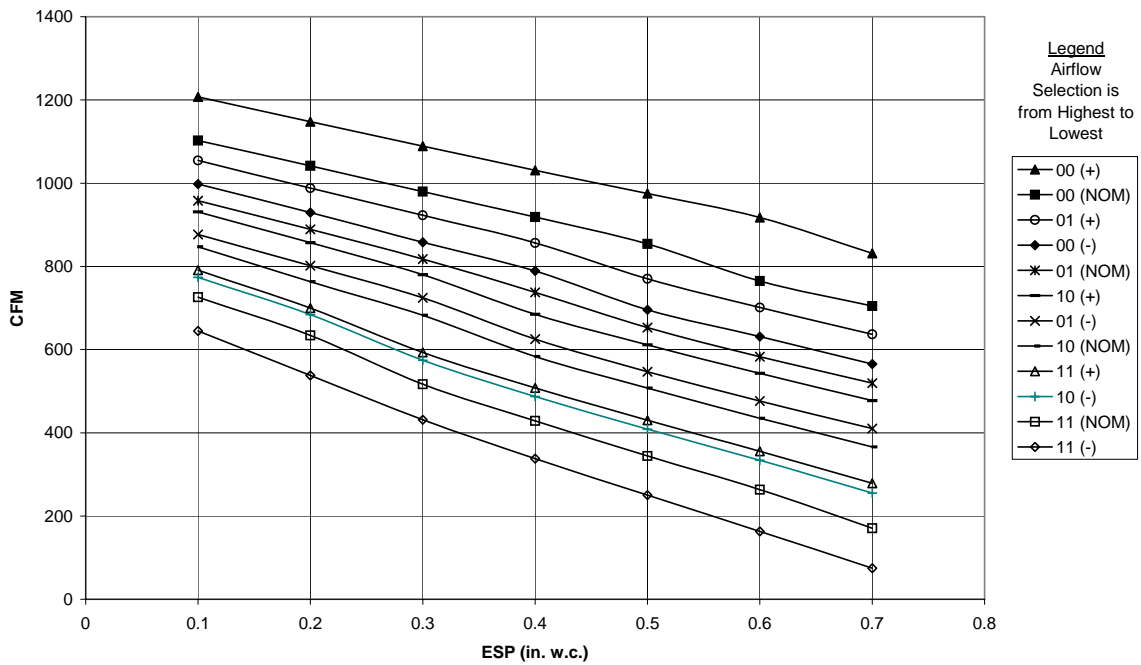

NOTE: OFF = 0 / ON = 1

Circulation Air Blower Data - *9MPV100

Cooling Adjustment					** Adjust Jumper Setting	Heating Rise Adjustment		
DIP Switch (OFF = 0 ON = 1)	High Cool @ .50 in wc(125 Pa)		Low Cool (80% of High Cool)			DIP Switch (OFF = 0 ON = 1)	High Heat Rise Change @ 0.20 in wc (50 Pa)	Low Heat Rise Change at Resultant Static
	5 & 6	CFM	L/s	CFM				
00	2144	1012	1715	809	+	00	-4	-4
*00	2013	950	1610	760	*NOM	*00	0	0
00	1842	869	1474	696	-	00	5	5
01	1772	836	1418	669	+	01	2	1
01	1624	766	1299	613	NOM	01	8	7
01	1471	694	1177	555	-	01	14	14
10	1367	645	1094	516	+	10	0	-1
10	1227	579	982	463	NOM	10	6	5
10	1077	508	862	407	-	10	13	11
11	930	439	744	351	+	11	-6	-7
11	808	380	646	305	NOM	11	-2	-2
11	634	299	507	239	-	11	3	3

Airflow performance includes 1" washable filter media.

*Factory Setting

**Adjust Jumper Setting (+, NOM, -) is applied to both Cooling and Heating

Note 1: HP Mode Jumper provides a 10% reduction in airflow when in Comfort position and a call for low or high cooling is present with the "O" line off. This feature is to provide lower airflow for running in HP Heating Mode if desirable.

Note 2: DEHUM mode (24VAC on DEHUM terminal) provides a 20% airflow reduction during cooling calls.

Note 3: Low Heat ESP is a result of High Heat ESP (- is decrease in rise).

Note 4: High and low heat rise values are approximate air temperature change from return air temperature when at factory default settings.

Table 2	Airflow	
DIP Switch (OFF = 0 / ON = 1)	Continuous Fan @ 0.10 in wc (25 Pa) ESP	
1 & 2	CFM	L/s
*00	1007	475
01	1742	822
10	2204	1040
11	2204	1040

Table 3	SW2 DIP Assignments
DIP Switch	Blower Parameter
1 & 2	Cont Fan Adj
3 & 4	Heat Speed Adj
5 & 6	Cool Speed Adj
7 & 8	Cool On/Off Delay

* Factory Setting

Table 4	Cooling Delay Options (SW2 - 7, 8)			
	ON DELAY		OFF DELAY	
	DIP SW2 - 7/8 (OFF = 0 / ON = 1)	Timed ON (sec)	Airflow during on delay	Timer OFF (sec)
*00	5	OFF	90	100%
01	5	OFF	0	OFF
10	30	50%	30	100%
11	30	50%	180	50%

Airflow % is of High Cool airflow demand determined from SW2-5/6 Table 1

Airflow resumes to 100% after on delay time is completed

Airflow stops (or switches to continuous fan speed) after off delay time is completed

* Factory Setting

MAX CFM (L/s) for Factory Washable Filters		
Filter Size (in/mm)	CFM	L/s
14" X 25" (356 x 635)	1400	661
16" X 25" (406 x 635)	1600	755
20" X 25" (508 x 635)	2000	944
24" X 25" (610 x 635)	2500	1180
Max CFM (L/s) based on 600 FPM (3.0 M/s)		

NOTE: Disposable filters are typically rated at 300 FPM (1.5 M/s). These filters only allow half the airflow when compared to 600 FPM (3.0 M/s) filters.

EXAMPLE (approx.):

20in X 25in @ 600 FPM = 2000 CFM, @ 300 FPM = 1000 CFM
508mm x 635mm @ 3.0 M/s = 944 L/s, @ 1.5 M/s = 472 L/s

Circulation Air Blower Data - *9MPV100

Cooling Airflow Settings

High Cooling Airflows *9MPV100J20

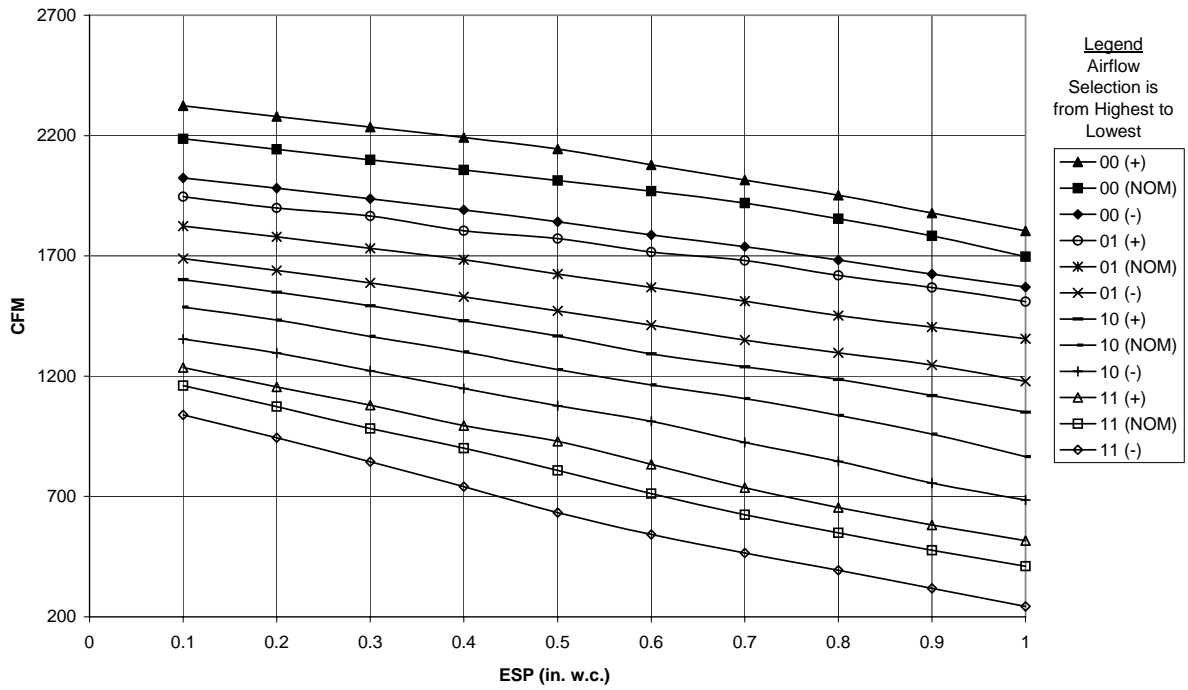

Low Cooling Airflows *9MPV100J20

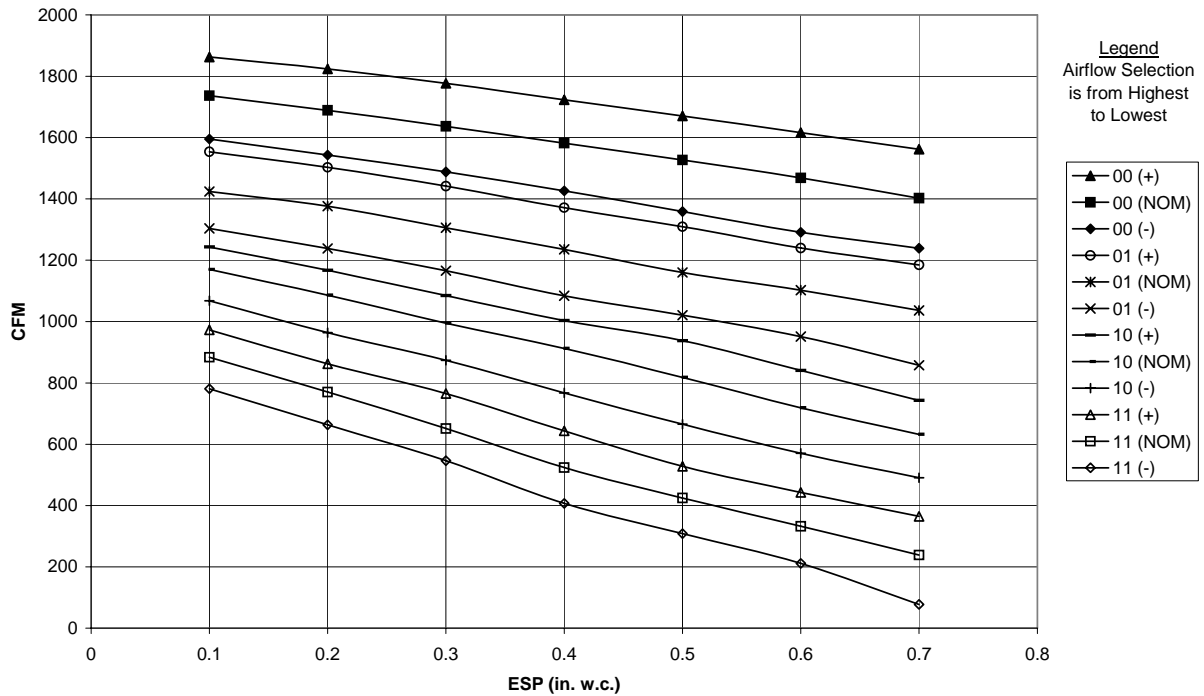

NOTE: OFF = 0 / ON = 1

Circulation Air Blower Data - *9MPV125

Cooling Adjustment					** Adjust Jumper Setting	Heating Rise Adjustment		
DIP Switch (OFF = 0 ON = 1)	High Cool @ .50 in wc(125 Pa)		Low Cool (80% of High Cool)			DIP Switch (OFF = 0 ON = 1)	High Heat Rise Change @ 0.20 in wc (50 Pa)	Low Heat Rise Change at Resultant Static
	5 & 6	CFM	L/s	CFM				
00	2150	1015	1720	812	+	00	-4	-4
*00	2025	956	1620	764	*NOM	*00	0	0
00	1856	876	1485	700	-	00	4	5
01	1755	828	1404	663	+	01	1	2
01	1615	762	1292	610	NOM	01	6	7
01	1452	685	1162	548	-	01	12	13
10	1338	631	1070	505	+	10	-1	0
10	1201	567	961	454	NOM	10	3	4
10	1069	504	855	403	-	10	9	10
11	909	429	727	343	+	11	-6	-6
11	800	377	640	302	NOM	11	-3	-3
11	627	296	502	237	-	11	3	3

Airflow performance includes 1" washable filter media.

*Factory Setting

**Adjust Jumper Setting (+, NOM, -) is applied to both Cooling and Heating

Note 1: HP Mode Jumper provides a 10% reduction in airflow when in Comfort position and a call for low or high cooling is present with the "O" line off. This feature is to provide lower airflow for running in HP Heating Mode if desirable.

Note 2: DEHUM mode (24VAC on DEHUM terminal) provides a 20% airflow reduction during cooling calls.

Note 3: Low Heat ESP is a result of High Heat ESP (- is decrease in rise).

Note 4: High and low heat rise values are approximate air temperature change from return air temperature when at factory default settings.

Table 2	Airflow	
DIP Switch (OFF = 0 / ON = 1)	Continuous Fan @ 0.10 in wc (25 Pa) ESP	
1 & 2	CFM	L/s
*00	1032	487
01	1778	839
10	2178	1028
11	2178	1028

Table 3	SW2 DIP Assignments
DIP Switch	Blower Parameter
1 & 2	Cont Fan Adj
3 & 4	Heat Speed Adj
5 & 6	Cool Speed Adj
7 & 8	Cool On/Off Delay

* Factory Setting

Table 4	Cooling Delay Options (SW2 - 7, 8)			
	ON DELAY		OFF DELAY	
DIP SW2 - 7/8 (OFF = 0 / ON = 1)	Timed ON (sec)	Airflow during on delay	Timer OFF (sec)	Airflow during off delay
*00	5	OFF	90	100%
01	5	OFF	0	OFF
10	30	50%	30	100%
11	30	50%	180	50%

Airflow % is of High Cool airflow demand determined from SW2-5/6 Table 1

Airflow resumes to 100% after on delay time is completed

Airflow stops (or switches to continuous fan speed) after off delay time is completed

* Factory Setting

MAX CFM (L/s) for Factory Washable Fil- ters		
Filter Size (in/mm)	CFM	L/s
14" X 25" (356 x 635)	1400	661
16" X 25" (406 x 635)	1600	755
20" X 25" (508 x 635)	2000	944
24" X 25" (610 x 635)	2500	1180
Max CFM (L/s) based on 600 FPM (3.0 M/s)		

NOTE: Disposable filters are typically rated at 300 FPM (1.5 M/s). These filters only allow half the airflow when compared to 600 FPM (3.0 M/s) filters.

EXAMPLE (approx.):

20in X 25in @ 600 FPM = 2000 CFM, @ 300 FPM = 1000 CFM
508mm x 635mm @ 3.0 M/s = 944 L/s, @ 1.5 M/s = 472 L/s

Circulation Air Blower Data - *9MPV125

Cooling Airflow Setting

High Cooling Airflows *9MPV125L20

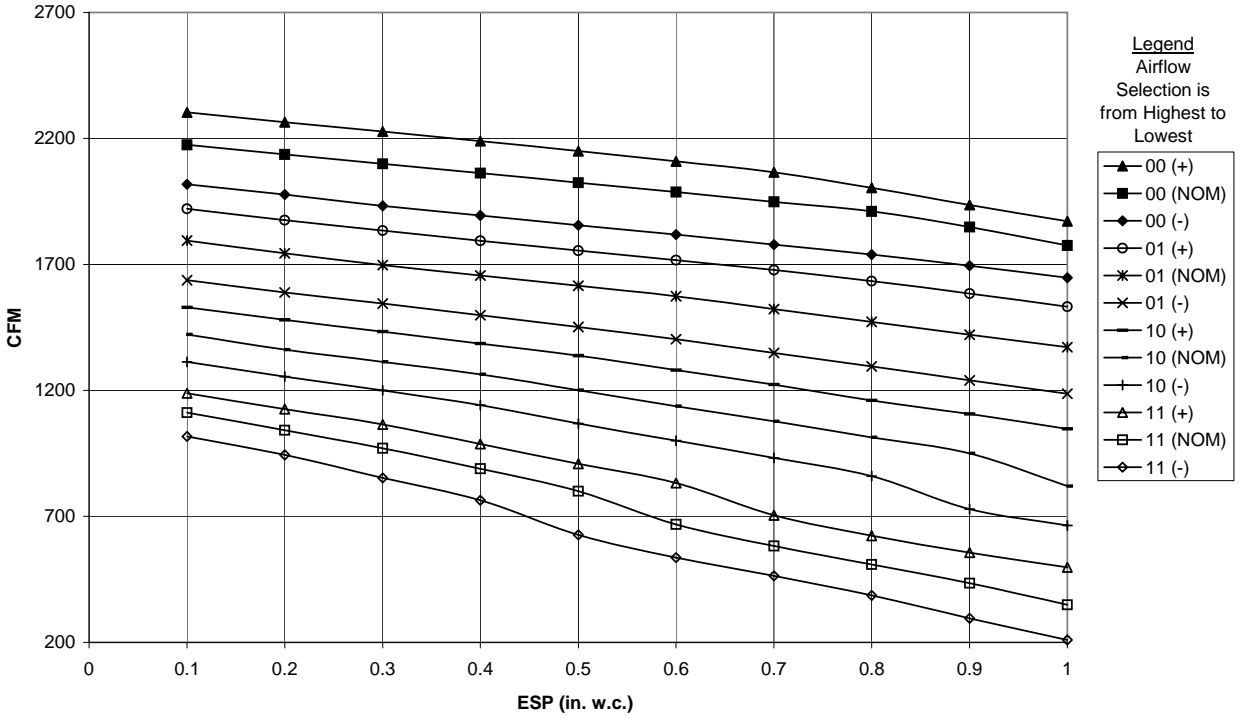

Low Cooling Airflows *9MPV125L20

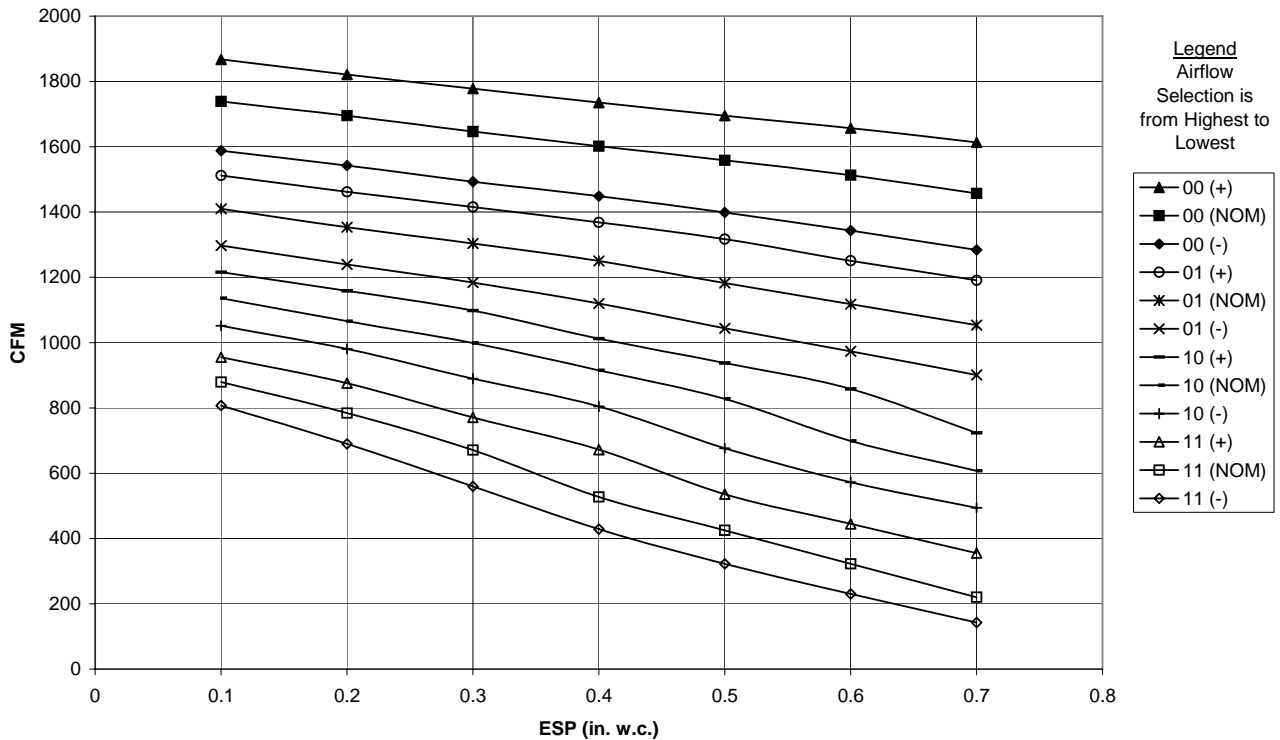

NOTE: OFF = 0 / ON = 1

Variable Speed (9MPV) Tap Select Interface Board (TSIB)

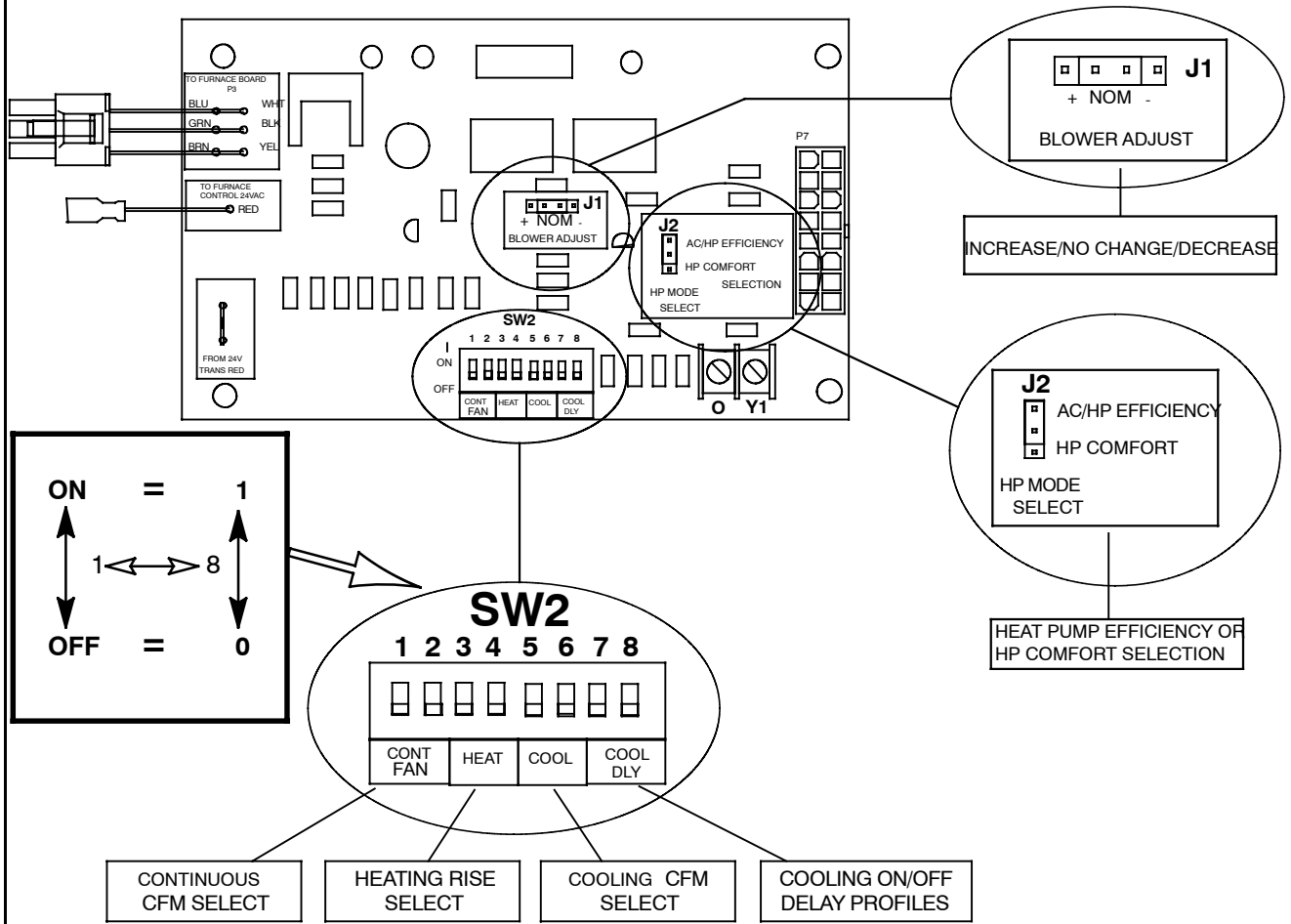

25-25-54

International Comfort Products, LLC
 Lewisburg, TN 37091 U.S.A.
www.GoTempstar.com